

Precision Monolithics Inc.

### FEATURES

- **Low Supply Current** ..... 55 $\mu$ A Max
- **Single-Supply Operation** ..... +5V to +30V
- **Dual-Supply Operation** .....  $\pm 2.5V$  to  $\pm 15V$
- **Low Input Offset Voltage** ..... 250 $\mu$ V Max
- **Low Input Offset Voltage Drift** ..... 1.5 $\mu$ V/ $^{\circ}$ C Max
- **High Common-Mode Input Range** ... V- to V+ (-1.5V)
- **High CMRR and PSRR** ..... 100dB Min
- **High Open-Loop Gain** ..... 120dB Min
- **No External Components Required**
- **741 Pinout and Nulling**
- **Available in Die Form**

### GENERAL DESCRIPTION

The OP-20 is a monolithic micropower operational amplifier that can be operated from a single power supply of +5V to +30V, or from dual supplies of  $\pm 2.5V$  to  $\pm 15V$ . The input voltage range extends to the negative rail, therefore input signals down to zero volts can be accommodated when operating from a single supply.

Precision performance in high-gain applications is readily obtained when using the OP-20. The B/F grade features a maximum input offset voltage of 250 $\mu$ V, minimum CMRR of 95dB, and open-loop gain of over 500,000. Quiescent supply current is a maximum of only 55 $\mu$ A at  $\pm 2.5V$  or 80 $\mu$ A at  $\pm 15V$ . The low input offset, high gain, and low power consumption brings precision performance to portable instruments, satellites, missile control systems, and many other battery-powered applications.

### PIN CONNECTIONS

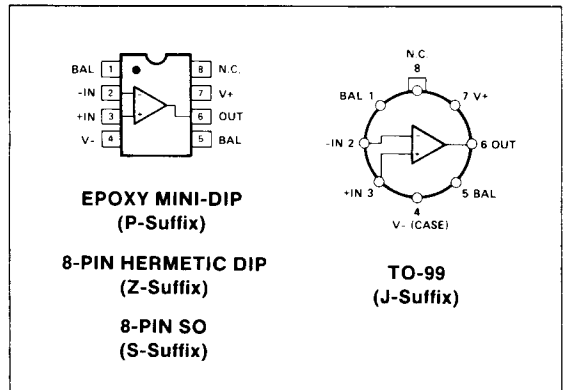

### ORDERING INFORMATION †

T <sub>a</sub> = +25 $^{\circ}$ C V <sub>OS</sub> MAX (mV)	PACKAGE			OPERATING TEMPERATURE RANGE
	TO-99	CERDIP 8-PIN	PLASTIC 8-PIN	
250	OP20BJ*	OP20BZ	-	MIL
250	OP20FJ	OP20FZ	-	IND
250	-	-	OP20FP	COM
500	-	OP20CZ	-	MIL
500	OP20GJ	OP20GZ	-	IND
500	-	-	OP20GP	COM
1000	OP20HJ	OP20HZ	OP20HS††	XIND
1000	-	-	OP20HP	XIND

\* For devices processed in total compliance to MIL-STD-883, add /883 after part number. Consult factory for 883 data sheet.

† Burn-in is available on commercial and industrial temperature range parts in cerDIP, plastic DIP, and TO-can packages. For ordering information, see 1990/91 Data Book, Section 2.

†† For availability and burn-in information on SO and PLCC packages, contact your local sales office.

### SIMPLIFIED SCHEMATIC

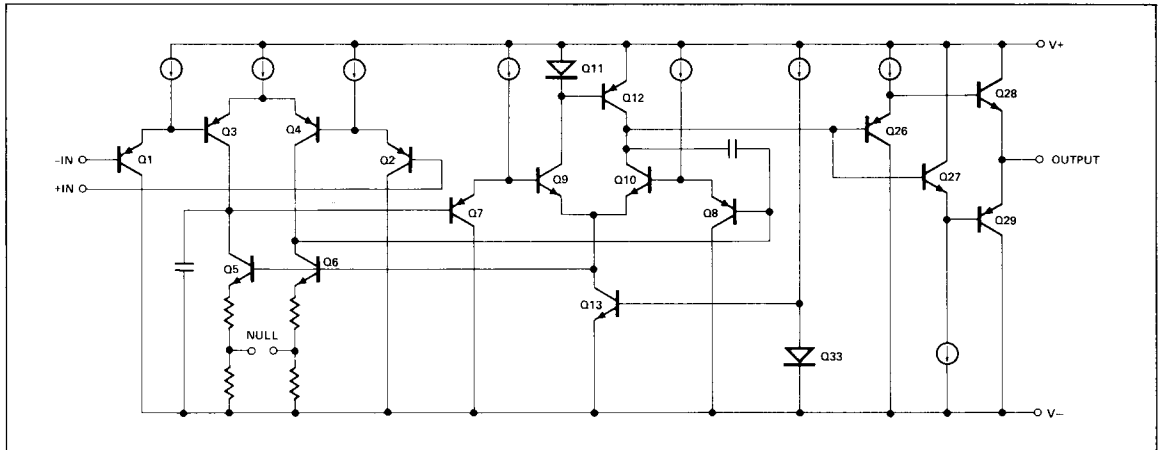

5  
OPERATIONAL AMPLIFIERS/BUFFERS

**ABSOLUTE MAXIMUM RATINGS** (Note 1)

Supply Voltage .....	±18V
Differential Input Voltage .....	±30V
Input Voltage .....	Supply Voltage
Output Short-Circuit Duration .....	Indefinite
Storage Temperature Range	
J and Z Packages .....	-65°C to +150°C
P Package .....	-65°C to +125°C
Operating Temperature Range	
OP-20B, OP-20C (J, Z) .....	-55°C to +125°C
OP-20F, OP-20G (J, Z) .....	-25°C to +85°C
OP-20H (S, P, J, Z) .....	-40°C to +85°C
OP-20FP, OP-20GP .....	0°C to +70°C
Lead Temperature Range (Soldering, 60 sec) .....	300°C
Junction Temperature .....	-65°C to +150°C

PACKAGE TYPE	$\theta_{JA}$ (NOTE 2)	$\theta_{JC}$	UNITS
TO-99 (J)	150	18	°C/W
8-Pin Hermetic DIP (Z)	148	16	°C/W
8-Pin Plastic DIP (P)	103	43	°C/W
8-Pin SO (S)	158	43	°C/W

**NOTES:**

1. Absolute maximum ratings apply to both DICE and packaged parts, unless otherwise noted.
2.  $\theta_{JA}$  is specified for worst case mounting conditions, i.e.,  $\theta_{JA}$  is specified for device in socket for TO, CerDIP and P-DIP packages;  $\theta_{JA}$  is specified for device soldered to printed circuit board for SO package.

**ELECTRICAL CHARACTERISTICS** at  $V_S = \pm 2.5V$  to  $\pm 15V$ ,  $T_A = +25^\circ C$ , unless otherwise noted.

PARAMETER	SYMBOL	CONDITIONS	OP-20B/F			OP-20C/G			OP-20H			UNITS
			MIN	TYP	MAX	MIN	TYP	MAX	MIN	TYP	MAX	
Input Offset Voltage	$V_{OS}$	$V_S = \pm 15V$	—	55	250	—	150	500	—	300	1000	$\mu V$
Input Offset Current	$I_{OS}$	$V_{CM} = 0$	—	0.15	1.5	—	0.2	2.5	—	0.3	4.0	nA
Input Bias Current	$I_B$	$V_{CM} = 0$	—	12	25	—	14	30	—	16	40	nA
Input Voltage Range	IVR	$V^+ = +5V$ , $V^- = 0V$ $V_S = \pm 15V$	0/3.5	—	—	0/3.5	—	—	0/3.5	—	—	V
Common-Mode Rejection Ratio	CMRR	$V^+ = +5V$ , $V^- = 0V$ $0V \leq V_{CM} \leq 3.5V$	95	105	—	90	95	—	85	90	—	dB
		$V_S = \pm 15V$ $-15V \leq V_{CM} \leq 13.5V$	100	110	—	94	105	—	90	100	—	dB
Power Supply Rejection Ratio	PSRR	$V_S = \pm 2.5V$ to $\pm 15V$ and $V^- = 0V$ , $V^+ = 5V$ to $30V$	—	4	6	—	6	10	—	10	32	$\mu V/V$
Large-Signal Voltage Gain	$A_{VO}$	$V^+ = +5V$ , $V^- = 0V$ $1V \leq V_O \leq 3.5V$	300	500	—	200	500	—	—	500	—	V/mV
		$V_S = \pm 15V$ , $V_O = \pm 10V$ $R_L = 25k\Omega$	1000	2000	—	800	2000	—	500	1000	—	V/mV
Output Voltage Swing	$V_O$	$V^+ = 5V$ , $V^- = 0V$ $R_L = 10k\Omega$ $V_S = \pm 15V$ , $R_L = 25k\Omega$	0.6/4.1	—	—	0.7/4.1	—	—	0.8/4.0	—	—	V
Closed-Loop Bandwidth	BW	$A_{VCL} = +1.0$ , $R_L = 10k\Omega$	—	100	—	—	100	—	—	100	—	kHz
Slew Rate	SR	$V_S = \pm 15V$ $R_L = 25k\Omega$	—	0.05	—	—	0.05	—	—	0.05	—	V/ $\mu s$
Supply Current	$I_{SY}$	$V_S = \pm 2.5V$ , No Load	—	40	55	—	44	63	—	45	70	$\mu A$
		$V_S = \pm 15V$ , No Load	—	55	80	—	57	85	—	60	95	$\mu A$

**ELECTRICAL CHARACTERISTICS** at  $V_S = \pm 2.5V$  to  $\pm 15V$ ,  $-55^\circ C \leq T_A \leq +125^\circ C$  for OP-20BJ/BZ and OP-20CZ,  $-25^\circ C \leq T_A \leq +85^\circ C$  for OP-20FJ/FZ and OP-20GJ/GZ, and  $0^\circ C \leq T_A \leq +70^\circ C$  for OP-20FP, OP-20GP, and  $-40^\circ C \leq T_A \leq +85^\circ C$  for OP-20HZ, OP-20HJ, and OP-20HP/HS, unless otherwise noted.

PARAMETER	SYMBOL	CONDITIONS	OP-20B/F			OP-20C/G			OP-20H			UNITS
			MIN	TYP	MAX	MIN	TYP	MAX	MIN	TYP	MAX	
Average Input Offset Voltage Drift (Note 1)	$TCV_{OS}$	Unnulled	—	0.75	1.5	—	1.0	3.0	—	1.5	7.0	$\mu V/^\circ C$
Input Offset Voltage	$V_{OS}$	$V_S = \pm 15V$	—	155	400	—	250	800	—	500	1700	$\mu V$
Input Offset Current	$I_{OS}$	$V_{CM} = 0$	—	0.5	2.5	—	1.0	3.5	—	1.5	5.0	nA
Input Bias Current	$I_B$	$V_{CM} = 0$	—	12	27	—	14	33	—	16	45	nA
Input Voltage Range	IVR	$V+ = +5V, V- = 0V$ $V_S = \pm 15V$	0/3.2 -15/13.2	—	—	0/3.2 -15/13.2	—	—	0/3.2 -15/13.2	—	—	V
Common-Mode Rejection Ratio	CMRR	$V+ = +5V, V- = 0V$ $0V \leq V_{CM} \leq 3.2V$ $V_S = \pm 15V$ $-15V \leq V_{CM} \leq 13.2V$	90 96	100 110	—	85 90	90 105	—	80 85	85 100	—	dB
Power Supply Rejection Ratio	PSRR	$V_S = \pm 2.5V$ to $\pm 15V$ $V- = 0V,$ $V+ = 5V$ to $30V$	—	4	10	—	6	18	—	10	32	$\mu V/V$
Large-Signal Voltage Gain	$A_{VO}$	$V_S = \pm 15V, V_O = \pm 10V$ $R_L = 50k\Omega$	500	700	—	400	600	—	250	400	—	V/mV
Output Voltage Swing	$V_O$	$V+ = 5V, V- = 0V,$ $R_L = 50k\Omega$ $V_S = \pm 15V,$ $R_L = 50k\Omega$	0.8/4.0 $\pm 14.0$	—	—	0.9/3.9 $\pm 13.9$	—	—	1.0/3.8 $\pm 13.9$	—	—	V
Supply Current	$I_{SV}$	$V_S = \pm 2.5V,$ No Load or $+5V, 0V$ $V_S = \pm 15V,$ No Load	—	50	65	—	53	75	—	55	85	$\mu A$

**NOTE:**

1. Sample tested.

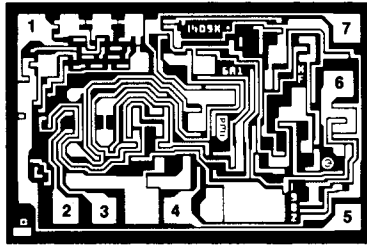
**DICE CHARACTERISTICS**

DIE SIZE 0.069 × 0.046 inch, 3174 sq. mils  
(1.75 × 1.17 mm, 2.05 sq. mm)

1. BALANCE
2. INVERTING INPUT
3. NONINVERTING INPUT
4. V-
5. BALANCE
6. OUTPUT
7. V+

For additional DICE ordering information,  
refer to 1990/91 Data Book, Section 2.

**WAFER TEST LIMITS** at  $V_S = \pm 15V$ ,  $T_A = 25^\circ C$ , unless otherwise noted.

PARAMETER	SYMBOL	CONDITIONS	OP-20N LIMIT	OP-20G LIMIT	OP-20GR LIMIT	UNITS
Input Offset Voltage	$V_{OS}$		300	600	1000	$\mu V$ MAX
Input Offset Current	$I_{OS}$		1.5	2.5	4.0	nA MAX
Input Bias Current	$I_B$		25	30	40	nA MAX
Input Voltage Range	IVR	$V_+ = +5V, V_- = 0V$ $V_S = \pm 15V$	0/3.5 -15/13.5	0/3.5 -15/13.5	0/3.5 -15/13.5	V MIN
Common-Mode Rejection Ratio	CMRR	$V_+ = +5V, V_- = 0V, 0V \leq V_{CM} \leq +3.5V$ $V_S = \pm 15V, -15V \leq V_{CM} \leq \pm 13.5V$	95 100	90 94	85 90	dB MIN
Power Supply Rejection Ratio	PSRR	$V_S = \pm 2.5V$ to $\pm 15V$ $V_- = 0V, V_+ = +5V$ to $+30V$	6	10	32	$\mu V/V$ MAX
Large-Signal Voltage Gain	$A_{VO}$	$R_L = 25k\Omega$ $V_O = \pm 10V$	1000	800	500	V/mV MIN
Output Voltage Swing	$V_O$	$R_L = 10k\Omega, V_+ = +5V, V_- = 0V$ $R_L = 25k\Omega, V_S = \pm 15V$	0.7/4.1 $\pm 14.1$	0.8/4.1 $\pm 14.1$	0.9/4.0 $\pm 14.0$	V MIN
Supply Current	$I_{SV}$	$V_S = \pm 2.5V$ , No Load $V_S = \pm 15V$ , No Load	55 80	63 85	70 95	$\mu A$ MAX

**NOTE:**

Electrical tests are performed at wafer probe to the limits shown. Due to variations in assembly methods and normal yield loss, yield after packaging is not guaranteed for standard product dice. Consult factory to negotiate specifications based on dice lot qualification through sample lot assembly and testing.

**TYPICAL ELECTRICAL CHARACTERISTICS** at  $V_S = \pm 15V$ ,  $T_A = +25^\circ C$ , unless otherwise noted.

PARAMETER	SYMBOL	CONDITIONS	OP-20N TYPICAL	OP-20G TYPICAL	OP-20GR TYPICAL	UNITS
Average Input Offset Voltage Drift	$TCV_{OS}$ $TCV_{OSn}$	Unnulled Nulled, $R_P = 10k\Omega$	1.0 1.0	1.5 1.5	2.5 2.5	$\mu V/^\circ C$
Large-Signal Voltage Gain	$A_{VO}$	$R_L = 25k\Omega$	2000	2000	1000	V/mV

TYPICAL PERFORMANCE CHARACTERISTICS

TRIMMED OFFSET VOLTAGE vs TEMPERATURE

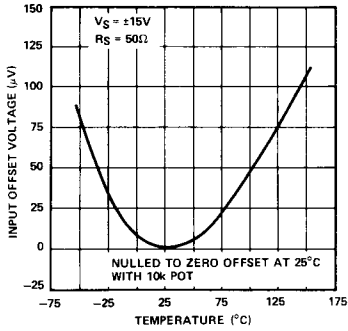

INPUT OFFSET VOLTAGE vs POWER SUPPLY VOLTAGE

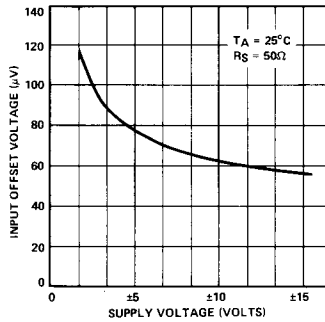

CLOSED-LOOP GAIN vs FREQUENCY

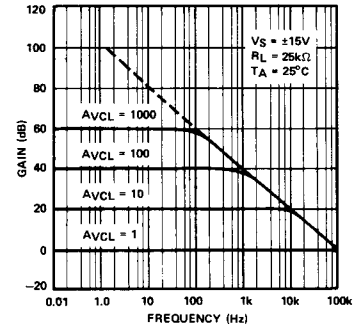

INPUT BIAS CURRENT vs TEMPERATURE

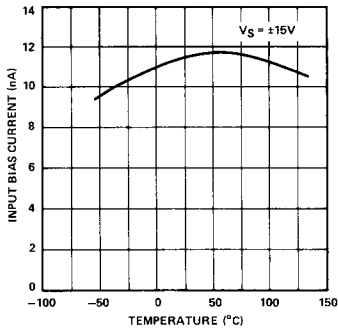

INPUT OFFSET CURRENT vs TEMPERATURE

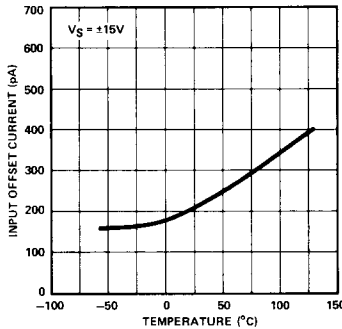

SUPPLY CURRENT vs SUPPLY VOLTAGE

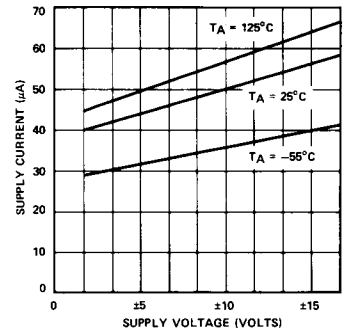

SMALL-SIGNAL TRANSIENT RESPONSE

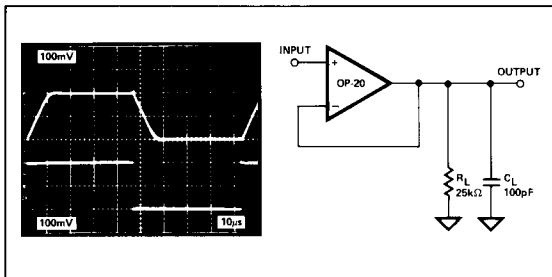

LARGE-SIGNAL TRANSIENT RESPONSE

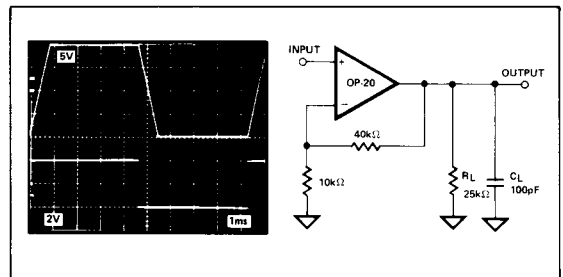

5 OPERATIONAL AMPLIFIERS/BUFFERS

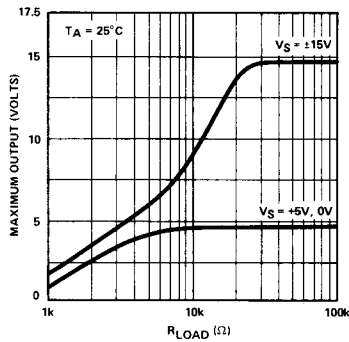
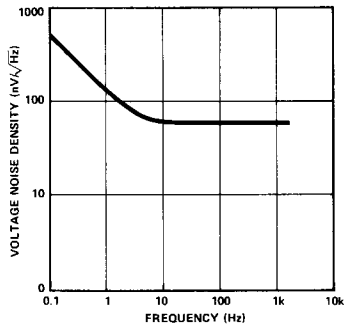
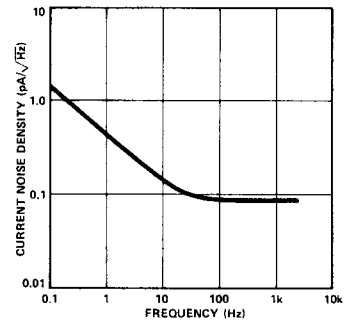
**TYPICAL PERFORMANCE CHARACTERISTICS**
**MAXIMUM OUTPUT VOLTAGE vs LOAD RESISTANCE**

**VOLTAGE NOISE DENSITY vs FREQUENCY**

**CURRENT NOISE DENSITY vs FREQUENCY**

**TYPICAL APPLICATIONS**
**TEMPERATURE SENSOR**
