

## OPA2188 0.03- $\mu\text{V}/^\circ\text{C}$ Drift, Low-Noise, Rail-to-Rail Output, 36-V, Zero-Drift Operational Amplifiers

### 1 Features

- Low Offset Voltage: 25  $\mu\text{V}$  (Maximum)
- Zero-Drift: 0.03  $\mu\text{V}/^\circ\text{C}$
- Low Noise: 8.8  $\text{nV}/\sqrt{\text{Hz}}$   
0.1-Hz to 10-Hz Noise: 0.25  $\mu\text{V}_{\text{PP}}$
- Excellent DC Precision:  
PSRR: 142 dB  
CMRR: 146 dB  
Open-Loop Gain: 136 dB
- Gain Bandwidth: 2 MHz
- Quiescent Current: 475  $\mu\text{A}$  (Maximum)
- Wide Supply Range:  $\pm 2\text{ V}$  to  $\pm 18\text{ V}$
- Rail-to-Rail Output:  
Input Includes Negative Rail
- RFI Filtered Inputs
- *MicroSIZE* Packages

### 2 Applications

- Bridge Amplifiers
- Strain Gauges
- Test Equipment
- Transducer Applications
- Temperature Measurement
- Electronic Scales
- Medical Instrumentation
- Resistance Temperature Detectors
- Precision Active Filters

### 3 Description

The OPA2188 operational amplifier uses TI proprietary auto-zeroing techniques to provide low offset voltage (25  $\mu\text{V}$ , maximum), and near zero-drift over time and temperature. This miniature, high-precision, low quiescent current amplifier offers high input impedance and rail-to-rail output swing within 15 mV of the rails. The input common-mode range includes the negative rail. Either single or dual supplies can be used in the range of 4 V to 36 V ( $\pm 2\text{ V}$  to  $\pm 18\text{ V}$ ).

The OPA2188 device is available in MSOP-8 and SO-8 packages. The device is specified for operation from  $-40^\circ\text{C}$  to  $+105^\circ\text{C}$ .

#### Device Information<sup>(1)</sup>

| PART NUMBER | PACKAGE   | BODY SIZE (NOM)   |
|-------------|-----------|-------------------|
| OPA2188     | SOIC (8)  | 4.90 mm x 3.91 mm |
|             | VSSOP (8) | 3.00 mm x 3.00 mm |

(1) For all available packages, see the orderable addendum at the end of the data sheet.

**Offset Voltage vs Temperature**

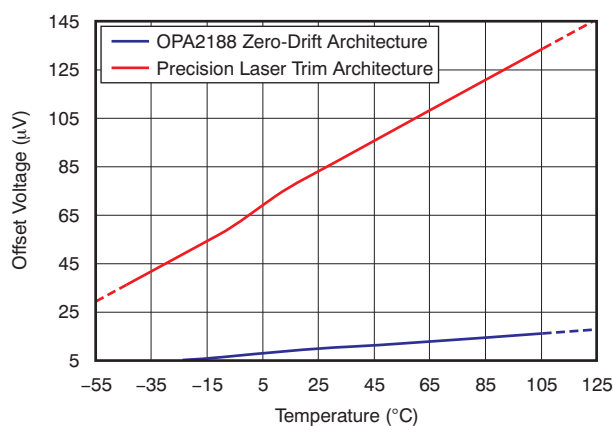

## Table of Contents

|   |           |  |           |
|---|-----------|--|-----------|
| <b>1 Features</b> .....   | <b>1</b>  | 8.3 Feature Description .....                                    | <b>18</b> |
| <b>2 Applications</b> .....   | <b>1</b>  | 8.4 Device Functional Modes .....                                | <b>20</b> |
| <b>3 Description</b> .....  | <b>1</b>  | <b>9 Application and Implementation</b> .....                    | <b>21</b> |
| <b>4 Revision History</b> .....   | <b>2</b>  | 9.1 Application Information .....                                | <b>21</b> |
| <b>5 Zero-Drift Amplifier Portfolio</b> .....   | <b>3</b>  | 9.2 Typical Applications .....                                   | <b>21</b> |
| <b>6 Pin Configuration and Functions</b> .....  | <b>3</b>  | 9.3 System Examples .....  | <b>22</b> |
| <b>7 Specifications</b> .....   | <b>4</b>  | <b>10 Power Supply Recommendations</b> .....                     | <b>23</b> |
| 7.1 Absolute Maximum Ratings .....  | <b>4</b>  | <b>11 Layout</b> .....   | <b>25</b> |
| 7.2 ESD Ratings .....   | <b>4</b>  | 11.1 Layout Guidelines .....                                     | <b>25</b> |
| 7.3 Recommended Operating Conditions .....  | <b>4</b>  | 11.2 Layout Example .....  | <b>25</b> |
| 7.4 Thermal Information .....   | <b>4</b>  | <b>12 Device and Documentation Support</b> .....                 | <b>26</b> |
| 7.5 Electrical Characteristics: High-Voltage Operation, $V_S = \pm 4$ V to $\pm 18$ V ( $V_S = 8$ V to 36 V) .....      | <b>5</b>  | 12.1 Device Support .....  | <b>26</b> |
| 7.6 Electrical Characteristics: Low-Voltage Operation, $V_S = \pm 2$ V to $< \pm 4$ V ( $V_S = +4$ V to $< +8$ V) ..... | <b>7</b>  | 12.2 Documentation Support .....                                 | <b>27</b> |
| 7.7 Typical Characteristics: Table of Graphs .....  | <b>9</b>  | 12.3 Receiving Notification of Documentation Updates .....       | <b>27</b> |
| 7.8 Typical Characteristics .....   | <b>10</b> | 12.4 Community Resource .....                                    | <b>27</b> |
| <b>8 Detailed Description</b> .....   | <b>17</b> | 12.5 Trademarks .....  | <b>27</b> |
| 8.1 Overview .....  | <b>17</b> | 12.6 Electrostatic Discharge Caution .....                       | <b>27</b> |
| 8.2 Functional Block Diagram .....  | <b>17</b> | 12.7 Glossary .....  | <b>27</b> |
|   |           | <b>13 Mechanical, Packaging, and Orderable Information</b> ..... | <b>27</b> |

## 4 Revision History

NOTE: Page numbers for previous revisions may differ from page numbers in the current version.

| <b>Changes from Revision B (September 2012) to Revision C</b>  | <b>Page</b> |
|--|-------------|
| • Added <i>ESD Ratings</i> table, <i>Feature Description</i> section, <i>Device Functional Modes</i> , <i>Application and Implementation</i> section, <i>Power Supply Recommendations</i> section, <i>Layout</i> section, <i>Device and Documentation Support</i> section, and <i>Mechanical, Packaging, and Orderable Information</i> section ..... | <b>1</b>    |
| • Changed Input Bias Current, $I_B$ and $I_{OS}$ parameters overtemperature maximum specification in <i>Electrical Characteristics: High-Voltage Operation</i> table .....   | <b>5</b>    |
| • Changed Noise, <i>Input voltage noise density</i> parameter units in <i>Electrical Characteristics: High-Voltage Operation</i> table ...   | <b>5</b>    |
| • Changed Power Supply, $I_Q$ parameter maximum specifications in <i>Electrical Characteristics: High-Voltage Operation</i> table .....  | <b>6</b>    |
| • Changed Input Bias Current, $I_B$ and $I_{OS}$ parameters overtemperature maximum specification in <i>Electrical Characteristics: Low-Voltage Operation</i> table .....  | <b>7</b>    |
| • Changed Noise, <i>Input voltage noise density</i> parameter units in <i>Electrical Characteristics: Low-Voltage Operation</i> table .....  | <b>7</b>    |
| • Changed Power Supply, $I_Q$ parameter maximum specifications in <i>Electrical Characteristics: Low-Voltage Operation</i> table .....   | <b>8</b>    |

| <b>Changes from Revision A (June 2012) to Revision B</b> | <b>Page</b> |
|--|-------------|
| • Changed second to last Applications bullet .....       | <b>1</b>    |

| <b>Changes from Original (August 2011) to Revision A</b>                 | <b>Page</b> |
|--|-------------|
| • Deleted all references to OPA188 and OPA4188 throughout document ..... | <b>1</b>    |
| • Updated document to current standards .....                            | <b>1</b>    |
| • Changed document status to <i>Production Data</i> .....                | <b>1</b>    |

## 5 Zero-Drift Amplifier Portfolio

| VERSION | PRODUCT                               | OFFSET VOLTAGE ( $\mu\text{V}$ ) | OFFSET VOLTAGE DRIFT ( $\mu\text{V}/^\circ\text{C}$ ) | BANDWIDTH (MHz) |
|---------|---------------------------------------|----------------------------------|---|-----------------|
| Single  | <a href="#">OPA188</a> (4 V to 36 V)  | 25                               | 0.085   | 2               |
|         | <a href="#">OPA333</a> (5 V)          | 10                               | 0.05  | 0.35            |
|         | <a href="#">OPA378</a> (5 V)          | 50                               | 0.25  | 0.9             |
|         | <a href="#">OPA735</a> (12 V)         | 5                                | 0.05  | 1.6             |
| Dual    | <a href="#">OPA2188</a> (4 V to 36 V) | 25                               | 0.085   | 2               |
|         | <a href="#">OPA2333</a> (5 V)         | 10                               | 0.05  | 0.35            |
|         | <a href="#">OPA2378</a> (5 V)         | 50                               | 0.25  | 0.9             |
|         | <a href="#">OPA2735</a> (12 V)        | 5                                | 0.05  | 1.6             |
| Quad    | <a href="#">OPA4188</a> (4 V to 36 V) | 25                               | 0.085   | 2               |
|         | <a href="#">OPA4330</a> (5 V)         | 50                               | 0.25  | 0.35            |

## 6 Pin Configuration and Functions

**D and DGK Packages  
8-Pin SOIC and MSOP  
Top View**

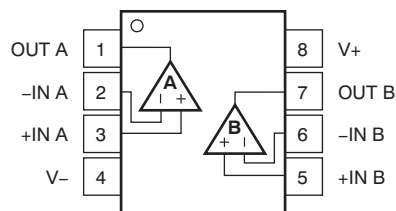

**Pin Functions**

| PIN   |     | I/O | DESCRIPTION                                     |
|-------|-----|-----|---|
| NAME  | NO. |     |   |
| -IN A | 2   | I   | Negative (inverting) input signal, channel A    |
| -IN B | 6   | I   | Negative (inverting) input signal, channel B    |
| +IN A | 3   | I   | Positive (noninverting) input signal, channel A |
| +IN B | 5   | I   | Positive (noninverting) input signal, channel B |
| OUT A | 1   | O   | Output, channel A                               |
| OUT B | 7   | O   | Output, channel B                               |
| V-    | 4   | —   | Negative (lowest) power supply                  |
| V+    | 8   | —   | Positive (highest) power supply                 |

## 7 Specifications

### 7.1 Absolute Maximum Ratings

over operating free-air temperature range (unless otherwise noted)<sup>(1)</sup>

|             |  | MIN                     | MAX                        | UNIT |
|-------------|--|-------------------------|----------------------------|------|
| Voltage     | Supply voltage                                 |                         | ±20, 40<br>(single supply) | V    |
|             | Signal input terminals, voltage <sup>(2)</sup> | (V <sub>-</sub> ) – 0.5 | (V <sub>+</sub> ) + 0.5    | V    |
| Current     | Signal input terminals, current <sup>(2)</sup> | –10                     | 10                         | mA   |
|             | Output short-circuit <sup>(3)</sup>            | Continuous              |                            |      |
| Temperature | Operating, T <sub>A</sub>                      | –55                     | 125                        | °C   |
|             | Junction, T <sub>J</sub>                       |                         | 150                        | °C   |
|             | Storage, T <sub>stg</sub>                      | –65                     | 150                        | °C   |

- (1) Stresses beyond those listed under *Absolute Maximum Ratings* may cause permanent damage to the device. These are stress ratings only, which do not imply functional operation of the device at these or any other conditions beyond those indicated under *Recommended Operating Conditions*. Exposure to absolute-maximum-rated conditions for extended periods may affect device reliability.
- (2) Input terminals are diode-clamped to the power-supply rails. Input signals that can swing more than 0.5 V beyond the supply rails should be current-limited to 10 mA or less.
- (3) Short-circuit to ground, one amplifier per package.

### 7.2 ESD Ratings

|                    |                         | VALUE  | UNIT  |
|--------------------|-------------------------|--|-------|
| V <sub>(ESD)</sub> | Electrostatic discharge | Human-body model (HBM), per ANSI/ESDA/JEDEC JS-001 <sup>(1)</sup>              | ±1500 |
|                    |                         | Charged-device model (CDM), per JEDEC specification JESD22-C101 <sup>(2)</sup> | ±1000 |

- (1) JEDEC document JEP155 states that 500-V HBM allows safe manufacturing with a standard ESD control process.
- (2) JEDEC document JEP157 states that 250-V CDM allows safe manufacturing with a standard ESD control process.

### 7.3 Recommended Operating Conditions

over operating free-air temperature range (unless otherwise noted)

|                |                             | MIN    | NOM | MAX      | UNIT |
|----------------|-----------------------------|--------|-----|----------|------|
| V <sub>S</sub> | Supply voltage              | 4 (±2) |     | 36 (±18) | V    |
| T <sub>A</sub> | Specified temperature range | –40    |     | +105     | °C   |

### 7.4 Thermal Information

| THERMAL METRIC <sup>(1)</sup> |  | OPA2188ID | OPA2188IDGK | UNIT |
|-------------------------------|--|-----------|-------------|------|
|                               |  | D (SOIC)  | DGK (VSSOP) |      |
|                               |  | 8 PINS    | 8 PINS      |      |
| R <sub>θJA</sub>              | Junction-to-ambient thermal resistance       | 111       | 159.3       | °C/W |
| R <sub>θJC(top)</sub>         | Junction-to-case (top) thermal resistance    | 54.9      | 37.4        | °C/W |
| R <sub>θJB</sub>              | Junction-to-board thermal resistance         | 51.7      | 48.5        | °C/W |
| Ψ <sub>JT</sub>               | Junction-to-top characterization parameter   | 9.3       | 1.2         | °C/W |
| Ψ <sub>JB</sub>               | Junction-to-board characterization parameter | 51.1      | 77.1        | °C/W |
| R <sub>θJC(bot)</sub>         | Junction-to-case (bottom) thermal resistance | n/a       | n/a         | °C/W |

- (1) For more information about traditional and new thermal metrics, see *Semiconductor and IC Package Thermal Metrics*.

## 7.5 Electrical Characteristics: High-Voltage Operation, $V_S = \pm 4\text{ V}$ to $\pm 18\text{ V}$ ( $V_S = 8\text{ V}$ to $36\text{ V}$ )

at  $T_A = 25^\circ\text{C}$ ,  $R_L = 10\text{ k}\Omega$  connected to  $V_S/2$ , and  $V_{\text{COM}} = V_{\text{OUT}} = V_S/2$ , unless otherwise noted.

| PARAMETER                  |                                   | TEST CONDITIONS  | MIN   | TYP              | MAX           | UNIT                             |
|----------------------------|-----------------------------------|--|-------|------------------|---------------|----------------------------------|
| <b>OFFSET VOLTAGE</b>      |                                   |  |       |                  |               |                                  |
| $V_{\text{OS}}$            | Input offset voltage              |  |       | 6                | 25            | $\mu\text{V}$                    |
|                            |                                   | $T_A = -40^\circ\text{C}$ to $+105^\circ\text{C}$  |       | 0.03             | 0.085         | $\mu\text{V}/^\circ\text{C}$     |
| PSRR                       | Power-supply rejection ratio      | $V_S = 4\text{ V}$ to $36\text{ V}$ , $V_{\text{CM}} = V_S/2$  |       | 0.075            | 0.3           | $\mu\text{V}/\text{V}$           |
|                            |                                   | $V_S = 4\text{ V}$ to $36\text{ V}$ , $V_{\text{CM}} = V_S/2$ ,<br>$T_A = -40^\circ\text{C}$ to $+105^\circ\text{C}$                           |       |                  | 0.3           | $\mu\text{V}/\text{V}$           |
|                            | Long-term stability               |  |       | 4 <sup>(1)</sup> |               | $\mu\text{V}$                    |
|                            | Channel separation, DC            |  |       | 1                |               | $\mu\text{V}/\text{V}$           |
| <b>INPUT BIAS CURRENT</b>  |                                   |  |       |                  |               |                                  |
| $I_B$                      | Input bias current                | $V_{\text{CM}} = V_S/2$  |       | $\pm 160$        | $\pm 850$     | $\text{pA}$                      |
|                            |                                   | $T_A = -40^\circ\text{C}$ to $+105^\circ\text{C}$  |       |                  | $\pm 18$      | $\text{nA}$                      |
| $I_{\text{OS}}$            | Input offset current              |  |       | $\pm 320$        | $\pm 1700$    | $\text{pA}$                      |
|                            |                                   | $T_A = -40^\circ\text{C}$ to $+105^\circ\text{C}$  |       |                  | $\pm 6$       | $\text{nA}$                      |
| <b>NOISE</b>               |                                   |  |       |                  |               |                                  |
| $e_n$                      | Input voltage noise               | $f = 0.1\text{ Hz}$ to $10\text{ Hz}$  |       | 0.25             |               | $\mu\text{V}_{\text{PP}}$        |
| $e_n$                      | Input voltage noise density       | $f = 1\text{ kHz}$   |       | 8.8              |               | $\text{nV}/\sqrt{\text{Hz}}$     |
| $i_n$                      | Input current noise density       | $f = 1\text{ kHz}$   |       | 7                |               | $\text{fA}/\sqrt{\text{Hz}}$     |
| <b>INPUT VOLTAGE RANGE</b> |                                   |  |       |                  |               |                                  |
| $V_{\text{CM}}$            | Common-mode voltage               |  | $V^-$ |                  | $(V^+) - 1.5$ | $\text{V}$                       |
| CMRR                       | Common-mode rejection ratio       | $(V^-) < V_{\text{CM}} < (V^+) - 1.5\text{ V}$   | 120   | 134              |               | $\text{dB}$                      |
|                            |                                   | $(V^-) + 0.5\text{ V} < V_{\text{CM}} < (V^+) - 1.5\text{ V}$ ,<br>$V_S = \pm 18\text{ V}$   | 130   | 146              |               | $\text{dB}$                      |
|                            |                                   | $(V^-) + 0.5\text{ V} < V_{\text{CM}} < (V^+) - 1.5\text{ V}$ ,<br>$V_S = \pm 18\text{ V}$ , $T_A = -40^\circ\text{C}$ to $+105^\circ\text{C}$ | 120   | 126              |               | $\text{dB}$                      |
| <b>INPUT IMPEDANCE</b>     |                                   |  |       |                  |               |                                  |
|                            | Differential                      |  |       | 100    6         |               | $\text{M}\Omega$    $\text{pF}$  |
|                            | Common-mode                       |  |       | 6    9.5         |               | $10^{12}\ \Omega$    $\text{pF}$ |
| <b>OPEN-LOOP GAIN</b>      |                                   |  |       |                  |               |                                  |
| $A_{\text{OL}}$            | Open-loop voltage gain            | $(V^-) + 500\text{ mV} < V_O < (V^+) - 500\text{ mV}$ ,<br>$R_L = 10\text{ k}\Omega$   | 130   | 136              |               | $\text{dB}$                      |
|                            |                                   | $(V^-) + 500\text{ mV} < V_O < (V^+) - 500\text{ mV}$ ,<br>$R_L = 10\text{ k}\Omega$ , $T_A = -40^\circ\text{C}$ to $+105^\circ\text{C}$       | 120   | 126              |               | $\text{dB}$                      |
| <b>FREQUENCY RESPONSE</b>  |                                   |  |       |                  |               |                                  |
| GBW                        | Gain-bandwidth product            |  |       | 2                |               | $\text{MHz}$                     |
| SR                         | Slew rate                         | $G = +1$   |       | 0.8              |               | $\text{V}/\mu\text{s}$           |
|                            | Settling time, 0.1%               | $V_S = \pm 18\text{ V}$ , $G = 1$ , 10-V step  |       | 20               |               | $\mu\text{s}$                    |
|                            | Settling time, 0.01%              | $V_S = \pm 18\text{ V}$ , $G = 1$ , 10-V step  |       | 27               |               | $\mu\text{s}$                    |
|                            | Overload recovery time            | $V_{\text{IN}} \times G = V_S$   |       | 1                |               | $\mu\text{s}$                    |
| THD+N                      | Total harmonic distortion + noise | 1 kHz, $G = 1$ , $V_{\text{OUT}} = 1\text{ V}_{\text{RMS}}$  |       | 0.0001           |               | %                                |

(1) 1000-hour life test at  $+125^\circ\text{C}$  demonstrated randomly distributed variation in the range of measurement limits—approximately  $4\ \mu\text{V}$ .

**Electrical Characteristics: High-Voltage Operation,  $V_S = \pm 4\text{ V}$  to  $\pm 18\text{ V}$  ( $V_S = 8\text{ V}$  to  $36\text{ V}$ ) (continued)**

 at  $T_A = 25^\circ\text{C}$ ,  $R_L = 10\text{ k}\Omega$  connected to  $V_S/2$ , and  $V_{\text{COM}} = V_{\text{OUT}} = V_S/2$ , unless otherwise noted.

| PARAMETER                      |                                   | TEST CONDITIONS   | MIN | TYP                             | MAX | UNIT          |
|--------------------------------|-----------------------------------|---|-----|---------------------------------|-----|---------------|
| <b>OUTPUT</b>                  |                                   |   |     |                                 |     |               |
| Voltage output swing from rail |                                   | No load   |     | 6                               | 15  | mV            |
|                                |                                   | $R_L = 10\text{ k}\Omega$   |     | 220                             | 250 | mV            |
|                                |                                   | $R_L = 10\text{ k}\Omega$ , $T_A = -40^\circ\text{C}$ to $+105^\circ\text{C}$ |     | 310                             | 350 | mV            |
| $I_{\text{SC}}$                | Short-circuit current             |   |     | $\pm 18$                        |     | mA            |
| $R_O$                          | Open-loop output resistance       | $f = 1\text{ MHz}$ , $I_O = 0$  |     | 120                             |     | $\Omega$      |
| $C_{\text{LOAD}}$              | Capacitive load drive             |   |     | 1                               |     | nF            |
| <b>POWER SUPPLY</b>            |                                   |   |     |                                 |     |               |
| $V_S$                          | Operating voltage                 |   |     | 4 to 36 ( $\pm 2$ to $\pm 18$ ) |     | V             |
| $I_Q$                          | Quiescent current (per amplifier) | $V_S = \pm 4\text{ V}$ to $V_S = \pm 18\text{ V}$                             |     | 415                             | 510 | $\mu\text{A}$ |
|                                |                                   | $I_O = 0\text{ mA}$ , $T_A = -40^\circ\text{C}$ to $+105^\circ\text{C}$       |     |                                 | 600 | $\mu\text{A}$ |

## 7.6 Electrical Characteristics: Low-Voltage Operation, $V_S = \pm 2\text{ V}$ to $< \pm 4\text{ V}$ ( $V_S = +4\text{ V}$ to $< +8\text{ V}$ )

at  $T_A = 25^\circ\text{C}$ ,  $R_L = 10\text{ k}\Omega$  connected to  $V_S/2$ , and  $V_{\text{COM}} = V_{\text{OUT}} = V_S/2$ , unless otherwise noted.

| PARAMETER                  |                                   | TEST CONDITIONS   | MIN   | TYP              | MAX           | UNIT                         |
|----------------------------|-----------------------------------|---|-------|------------------|---------------|------------------------------|
| <b>OFFSET VOLTAGE</b>      |                                   |   |       |                  |               |                              |
| $V_{\text{OS}}$            | Input offset voltage              |   |       | 6                | 25            | $\mu\text{V}$                |
|                            |                                   | $T_A = -40^\circ\text{C}$ to $+105^\circ\text{C}$   |       | 0.03             | 0.085         | $\mu\text{V}/^\circ\text{C}$ |
| PSRR                       | Power-supply rejection ratio      | $V_S = 4\text{ V}$ to $36\text{ V}$ , $V_{\text{CM}} = V_S/2$   |       | 0.075            | 0.3           | $\mu\text{V}/\text{V}$       |
|                            |                                   | $V_S = 4\text{ V}$ to $36\text{ V}$ , $V_{\text{CM}} = V_S/2$ ,<br>$T_A = -40^\circ\text{C}$ to $+105^\circ\text{C}$                          |       |                  | 0.3           | $\mu\text{V}/\text{V}$       |
|                            | Long-term stability               |   |       | 4 <sup>(1)</sup> |               | $\mu\text{V}$                |
|                            | Channel separation, dc            |   |       | 1                |               | $\mu\text{V}/\text{V}$       |
| <b>INPUT BIAS CURRENT</b>  |                                   |   |       |                  |               |                              |
| $I_B$                      | Input bias current                | $V_{\text{CM}} = V_S/2$   |       | $\pm 160$        | $\pm 850$     | pA                           |
|                            |                                   | $T_A = -40^\circ\text{C}$ to $+105^\circ\text{C}$   |       |                  | $\pm 18$      | nA                           |
| $I_{\text{OS}}$            | Input offset current              |   |       | $\pm 320$        | $\pm 1700$    | pA                           |
|                            |                                   | $T_A = -40^\circ\text{C}$ to $+105^\circ\text{C}$   |       |                  | $\pm 6$       | nA                           |
| <b>NOISE</b>               |                                   |   |       |                  |               |                              |
| $e_n$                      | Input voltage noise               | $f = 0.1\text{ Hz}$ to $10\text{ Hz}$   |       | 0.25             |               | $\mu\text{V}_{\text{PP}}$    |
|                            | Input voltage noise density       | $f = 1\text{ kHz}$  |       | 8.8              |               | $\text{nV}/\sqrt{\text{Hz}}$ |
| $i_n$                      | Input current noise density       | $f = 1\text{ kHz}$  |       | 7                |               | $\text{fA}/\sqrt{\text{Hz}}$ |
| <b>INPUT VOLTAGE RANGE</b> |                                   |   |       |                  |               |                              |
| $V_{\text{CM}}$            | Common-mode voltage range         | $T_A = -40^\circ\text{C}$ to $+105^\circ\text{C}$   | $V^-$ |                  | $(V^+) - 1.5$ | V                            |
| CMRR                       | Common-mode rejection ratio       | $(V^-) < V_{\text{CM}} < (V^+) - 1.5\text{ V}$  | 106   | 114              |               | dB                           |
|                            |                                   | $(V^-) + 0.5\text{ V} < V_{\text{CM}} < (V^+) - 1.5\text{ V}$ ,<br>$V_S = \pm 2\text{ V}$   | 114   | 120              |               | dB                           |
|                            |                                   | $(V^-) + 0.5\text{ V} < V_{\text{CM}} < (V^+) - 1.5\text{ V}$ ,<br>$V_S = \pm 2\text{ V}$ , $T_A = -40^\circ\text{C}$ to $+105^\circ\text{C}$ | 110   | 120              |               | dB                           |
| <b>INPUT IMPEDANCE</b>     |                                   |   |       |                  |               |                              |
|                            | Differential                      |   |       | 100    6         |               | $\text{M}\Omega$    pF       |
|                            | Common-mode                       |   |       | 6    95          |               | $10^{12}\ \Omega$    pF      |
| <b>OPEN-LOOP GAIN</b>      |                                   |   |       |                  |               |                              |
| $A_{\text{OL}}$            | Open-loop voltage gain            | $(V^-) + 500\text{ mV} < V_O < (V^+) - 500\text{ mV}$ ,<br>$R_L = 5\text{ k}\Omega$ , $V_S = 5\text{ V}$                                      | 110   | 120              |               | dB                           |
|                            |                                   | $(V^-) + 500\text{ mV} < V_O < (V^+) - 500\text{ mV}$ ,<br>$R_L = 10\text{ k}\Omega$  | 120   | 130              |               | dB                           |
|                            |                                   | $(V^-) + 500\text{ mV} < V_O < (V^+) - 500\text{ mV}$ ,<br>$R_L = 10\text{ k}\Omega$ , $T_A = -40^\circ\text{C}$ to $+105^\circ\text{C}$      | 114   | 120              |               | dB                           |
| <b>FREQUENCY RESPONSE</b>  |                                   |   |       |                  |               |                              |
| GBW                        | Gain-bandwidth product            |   |       | 2                |               | MHz                          |
| SR                         | Slew rate                         | $G = +1$  |       | 0.8              |               | $\text{V}/\mu\text{s}$       |
|                            | Overload recovery time            | $V_{\text{IN}} \times G = V_S$  |       | 1                |               | $\mu\text{s}$                |
| THD+N                      | Total harmonic distortion + noise | 1 kHz, $G = 1$ , $V_{\text{OUT}} = 1\text{ V}_{\text{RMS}}$   |       | 0.0001           |               | %                            |

(1) 1000-hour life test at  $+125^\circ\text{C}$  demonstrated randomly distributed variation in the range of measurement limits—approximately  $4\ \mu\text{V}$ .

**Electrical Characteristics: Low-Voltage Operation,  $V_S = \pm 2\text{ V}$  to  $< \pm 4\text{ V}$  ( $V_S = +4\text{ V}$  to  $< +8\text{ V}$ ) (continued)**

 at  $T_A = 25^\circ\text{C}$ ,  $R_L = 10\text{ k}\Omega$  connected to  $V_S/2$ , and  $V_{\text{COM}} = V_{\text{OUT}} = V_S/2$ , unless otherwise noted.

| PARAMETER                      |                                   | TEST CONDITIONS   | MIN                             | TYP      | MAX | UNIT             |
|--------------------------------|-----------------------------------|---|---------------------------------|----------|-----|------------------|
| <b>OUTPUT</b>                  |                                   |   |                                 |          |     |                  |
| Voltage output swing from rail |                                   | No load   |                                 | 6        | 15  | mV               |
|                                |                                   | $R_L = 10\text{ k}\Omega$   |                                 | 220      | 250 | mV               |
|                                |                                   | $R_L = 10\text{ k}\Omega$ , $T_A = -40^\circ\text{C}$ to $+105^\circ\text{C}$ |                                 | 310      | 350 | mV               |
| $I_{\text{SC}}$                | Short-circuit current             |   |                                 | $\pm 18$ |     | mA               |
| $R_O$                          | Open-loop output resistance       | $f = 1\text{ MHz}$ , $I_O = 0$  |                                 | 120      |     | $\Omega$         |
| $C_{\text{LOAD}}$              | Capacitive load drive             |   |                                 | 1        |     | nF               |
| <b>POWER SUPPLY</b>            |                                   |   |                                 |          |     |                  |
| $V_S$                          | Operating voltage range           |   | 4 to 36 ( $\pm 2$ to $\pm 18$ ) |          |     | V                |
| $I_Q$                          | Quiescent current (per amplifier) | $V_S = \pm 2\text{ V}$ to $V_S = \pm 4\text{ V}$                              |                                 | 385      | 485 | $\mu\text{A}$    |
|                                |                                   | $I_O = 0\text{ mA}$ , $T_A = -40^\circ\text{C}$ to $+105^\circ\text{C}$       |                                 |          | 590 | $\mu\text{A}$    |
| <b>TEMPERATURE RANGE</b>       |                                   |   |                                 |          |     |                  |
|                                | Specified temperature range       |   | -40                             |          | 105 | $^\circ\text{C}$ |
| $T_A$                          | Operating temperature range       |   | -40                             |          | 125 | $^\circ\text{C}$ |
| $T_{\text{stg}}$               | Storage temperature               |   | -65                             |          | 150 | $^\circ\text{C}$ |



## 7.7 Typical Characteristics: Table of Graphs

**Table 1. Characteristic Performance Measurements**

| DESCRIPTION  | FIGURE NO.                           |
|--|--------------------------------------|
| Offset Voltage Production Distribution                         | <a href="#">Figure 1</a>             |
| Offset Voltage Drift Distribution                              | <a href="#">Figure 2</a>             |
| Offset Voltage vs Temperature                                  | <a href="#">Figure 3</a>             |
| Offset Voltage vs Common-Mode Voltage                          | <a href="#">Figure 4, Figure 5</a>   |
| Offset Voltage vs Power Supply                                 | <a href="#">Figure 6</a>             |
| $I_B$ and $I_{OS}$ vs Common-Mode Voltage                      | <a href="#">Figure 7</a>             |
| Input Bias Current vs Temperature                              | <a href="#">Figure 8</a>             |
| Output Voltage Swing vs Output Current (Maximum Supply)        | <a href="#">Figure 9</a>             |
| CMRR and PSRR vs Frequency (Referred-to-Input)                 | <a href="#">Figure 10</a>            |
| CMRR vs Temperature  | <a href="#">Figure 11, Figure 12</a> |
| PSRR vs Temperature  | <a href="#">Figure 13</a>            |
| 0.1-Hz to 10-Hz Noise  | <a href="#">Figure 14</a>            |
| Input Voltage Noise Spectral Density vs Frequency              | <a href="#">Figure 15</a>            |
| THD+N Ratio vs Frequency                                       | <a href="#">Figure 16</a>            |
| THD+N vs Output Amplitude                                      | <a href="#">Figure 17</a>            |
| Quiescent Current vs Supply Voltage                            | <a href="#">Figure 18</a>            |
| Quiescent Current vs Temperature                               | <a href="#">Figure 19</a>            |
| Open-Loop Gain and Phase vs Frequency                          | <a href="#">Figure 20</a>            |
| Closed-Loop Gain vs Frequency                                  | <a href="#">Figure 21</a>            |
| Open-Loop Gain vs Temperature                                  | <a href="#">Figure 22</a>            |
| Open-Loop Output Impedance vs Frequency                        | <a href="#">Figure 23</a>            |
| Small-Signal Overshoot vs Capacitive Load (100-mV Output Step) | <a href="#">Figure 24, Figure 25</a> |
| No Phase Reversal  | <a href="#">Figure 26</a>            |
| Positive Overload Recovery                                     | <a href="#">Figure 27</a>            |
| Negative Overload Recovery                                     | <a href="#">Figure 28</a>            |
| Small-Signal Step Response (100 mV)                            | <a href="#">Figure 29, Figure 30</a> |
| Large-Signal Step Response                                     | <a href="#">Figure 31, Figure 32</a> |
| Large-Signal Settling Time (10-V Positive Step)                | <a href="#">Figure 33</a>            |
| Large-Signal Settling Time (10-V Negative Step)                | <a href="#">Figure 34</a>            |
| Short-Circuit Current vs Temperature                           | <a href="#">Figure 35</a>            |
| Maximum Output Voltage vs Frequency                            | <a href="#">Figure 36</a>            |
| Channel Separation vs Frequency                                | <a href="#">Figure 37</a>            |
| EMIRR IN+ vs Frequency   | <a href="#">Figure 38</a>            |

## 7.8 Typical Characteristics

$V_S = \pm 18\text{ V}$ ,  $V_{CM} = V_S/2$ ,  $R_{LOAD} = 10\text{ k}\Omega$  connected to  $V_S/2$ , and  $C_L = 100\text{ pF}$ , unless otherwise noted.

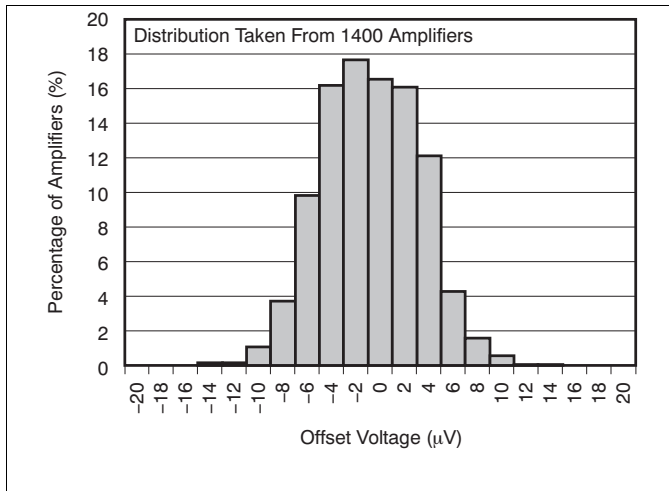

Figure 1. Offset Voltage Production Distribution

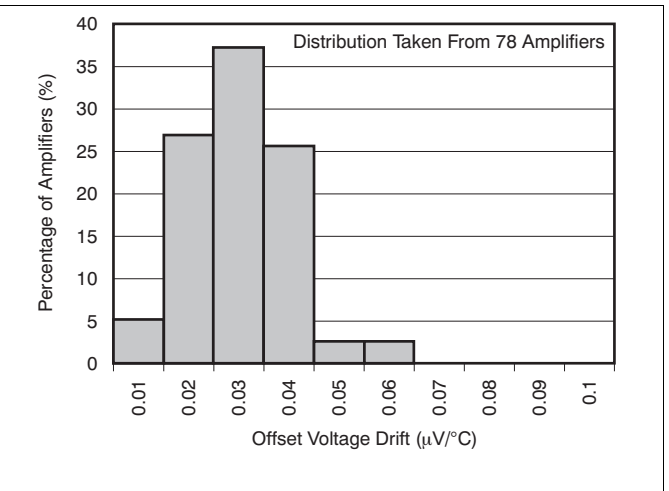

Figure 2. Offset Voltage Drift Distribution

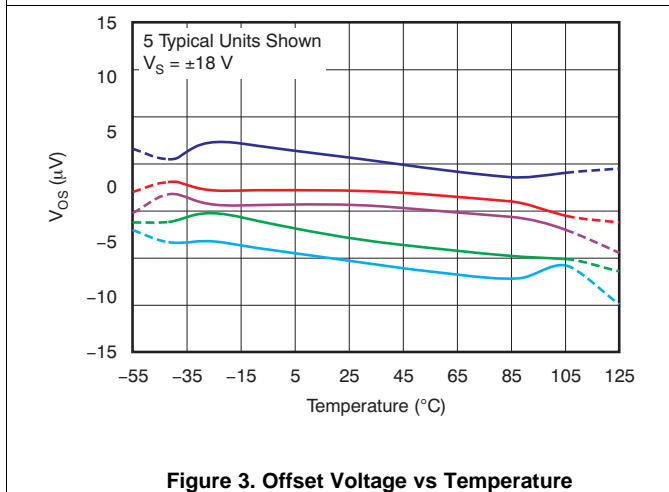

Figure 3. Offset Voltage vs Temperature

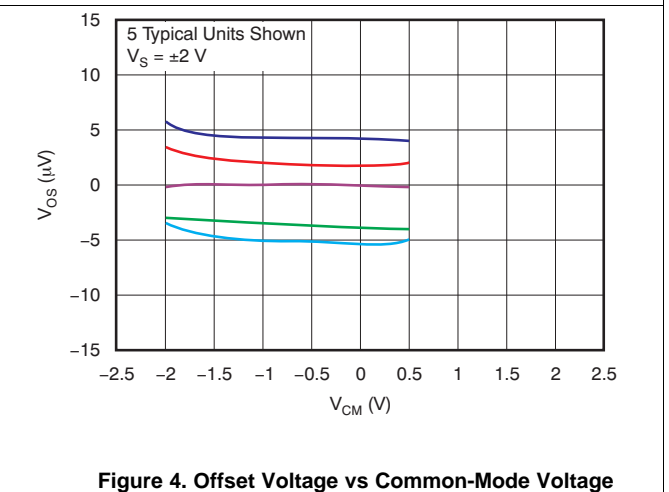

Figure 4. Offset Voltage vs Common-Mode Voltage

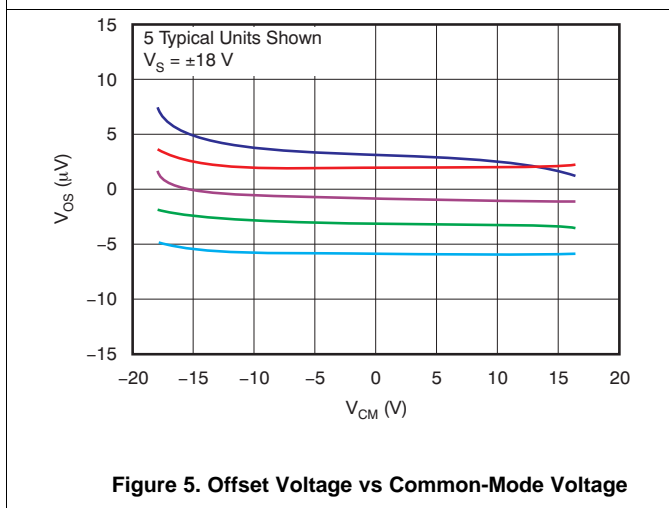

Figure 5. Offset Voltage vs Common-Mode Voltage

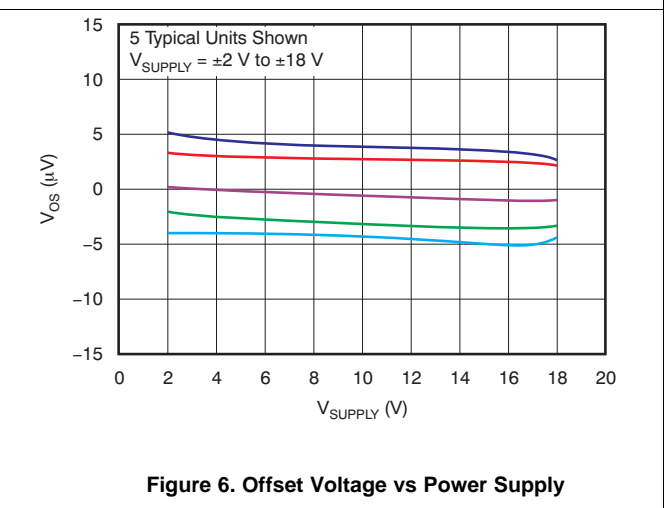

Figure 6. Offset Voltage vs Power Supply

Typical Characteristics (continued)

$V_S = \pm 18\text{ V}$ ,  $V_{CM} = V_S/2$ ,  $R_{LOAD} = 10\text{ k}\Omega$  connected to  $V_S/2$ , and  $C_L = 100\text{ pF}$ , unless otherwise noted.

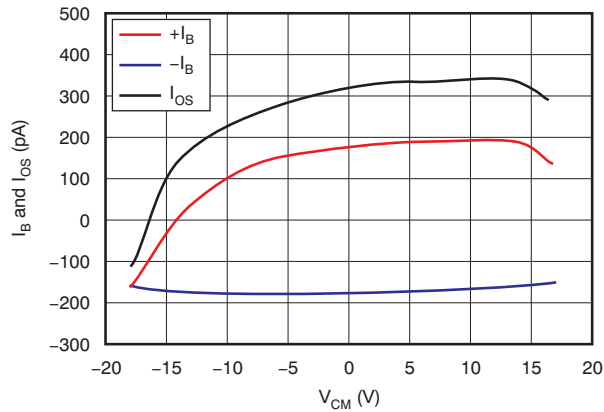

Figure 7.  $I_B$  and  $I_{OS}$  vs Common-Mode Voltage

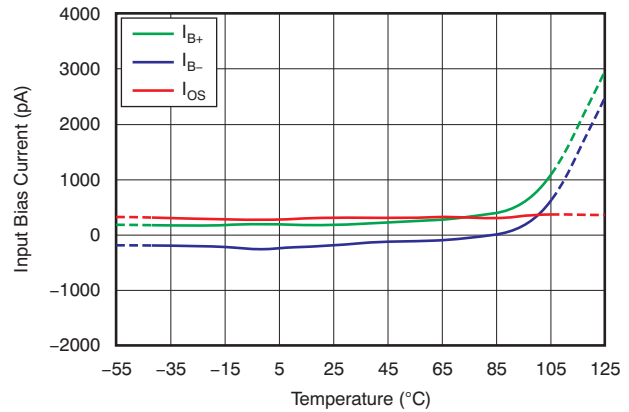

Figure 8. Input Bias Current vs Temperature

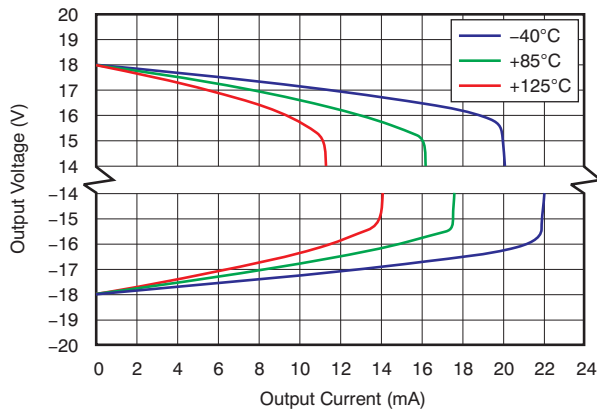

Figure 9. Output Voltage Swing vs Output Current (Maximum Supply)

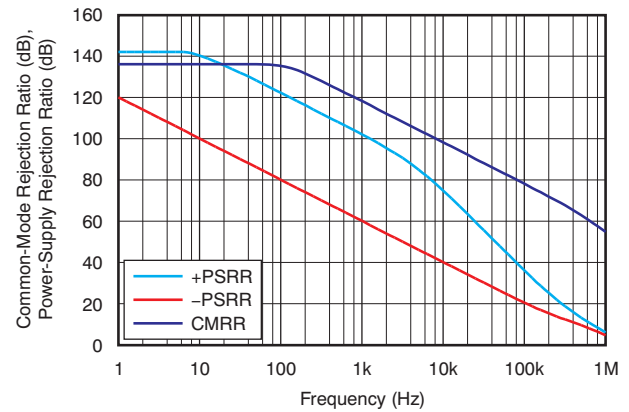

Figure 10. CMRR and PSRR vs Frequency (Referred-to-Input)

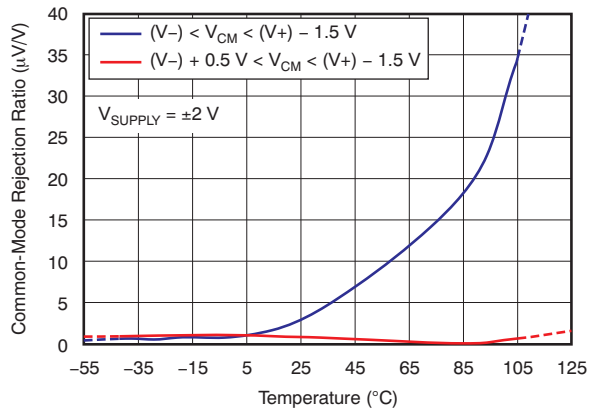

Figure 11. CMRR vs Temperature

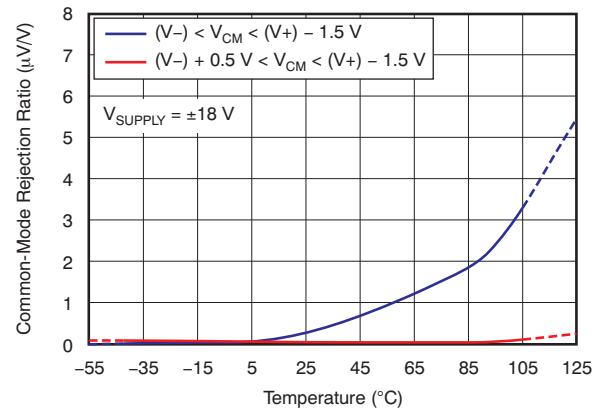

Figure 12. CMRR vs Temperature

Typical Characteristics (continued)

$V_S = \pm 18\text{ V}$ ,  $V_{CM} = V_S/2$ ,  $R_{LOAD} = 10\text{ k}\Omega$  connected to  $V_S/2$ , and  $C_L = 100\text{ pF}$ , unless otherwise noted.

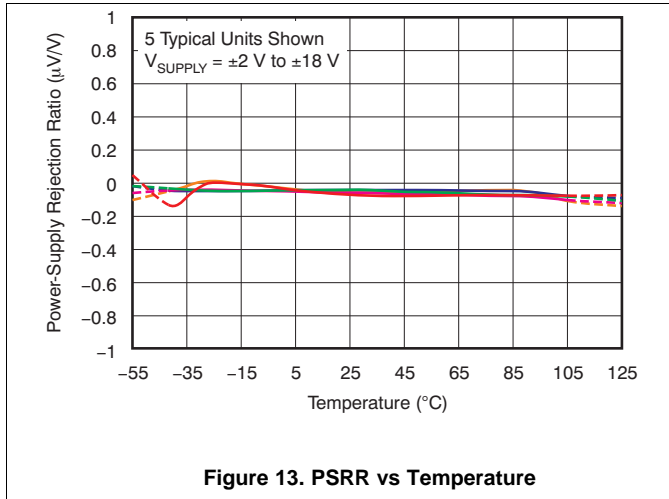

Figure 13. PSRR vs Temperature

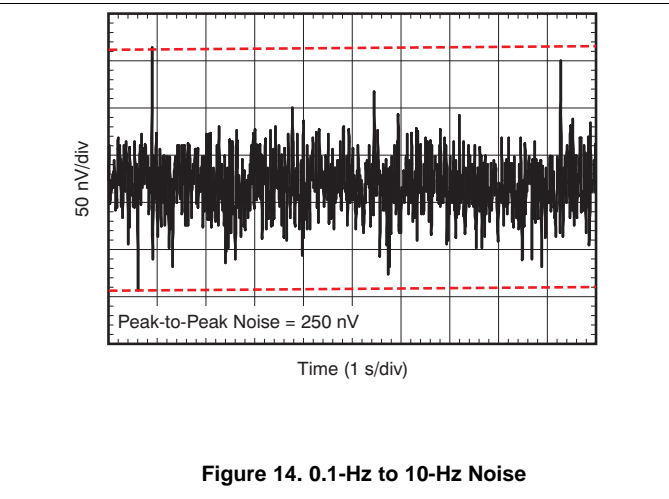

Figure 14. 0.1-Hz to 10-Hz Noise

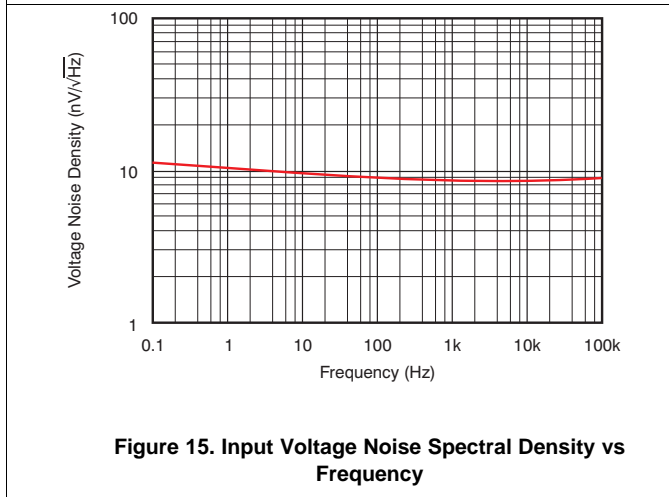

Figure 15. Input Voltage Noise Spectral Density vs Frequency

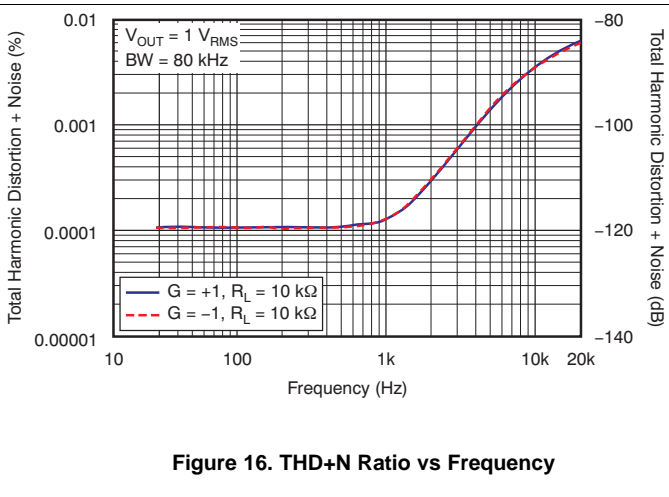

Figure 16. THD+N Ratio vs Frequency

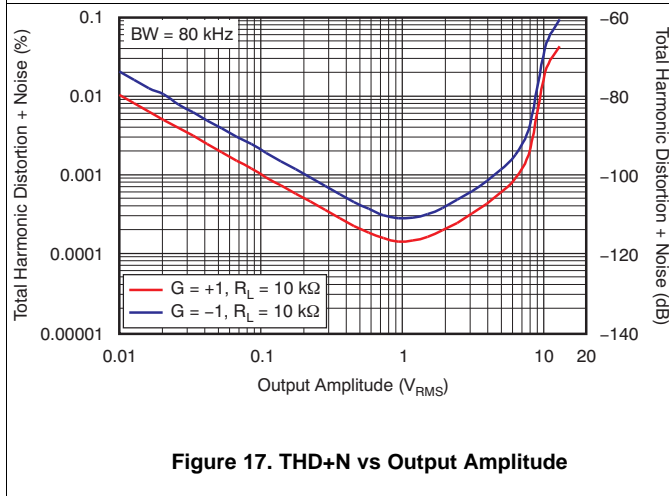

Figure 17. THD+N vs Output Amplitude

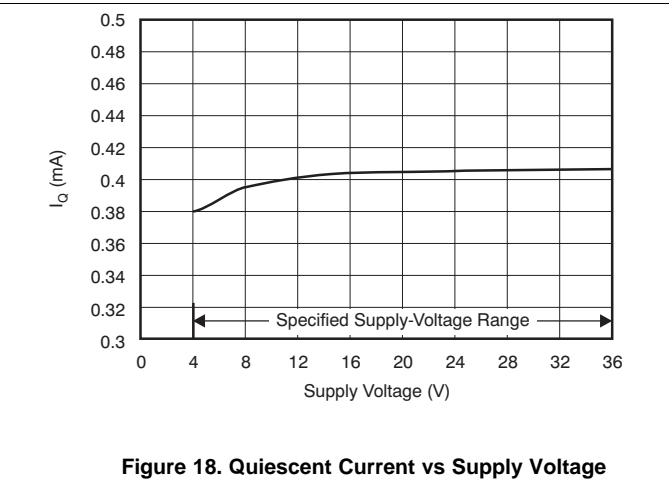

Figure 18. Quiescent Current vs Supply Voltage

Typical Characteristics (continued)

$V_S = \pm 18\text{ V}$ ,  $V_{CM} = V_S/2$ ,  $R_{LOAD} = 10\text{ k}\Omega$  connected to  $V_S/2$ , and  $C_L = 100\text{ pF}$ , unless otherwise noted.

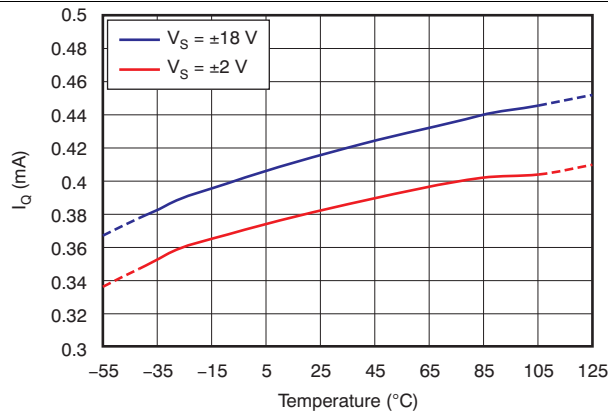

Figure 19. Quiescent Current vs Temperature

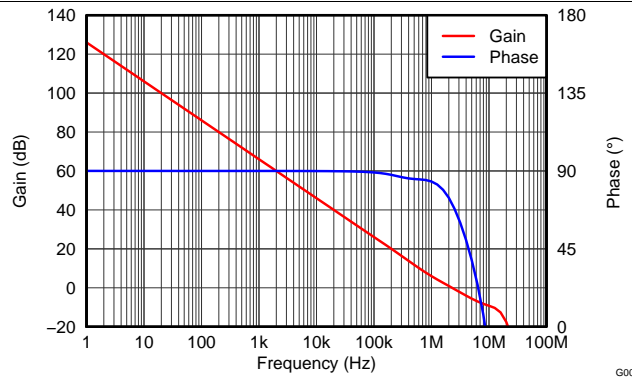

Figure 20. Open-Loop Gain and Phase vs Frequency

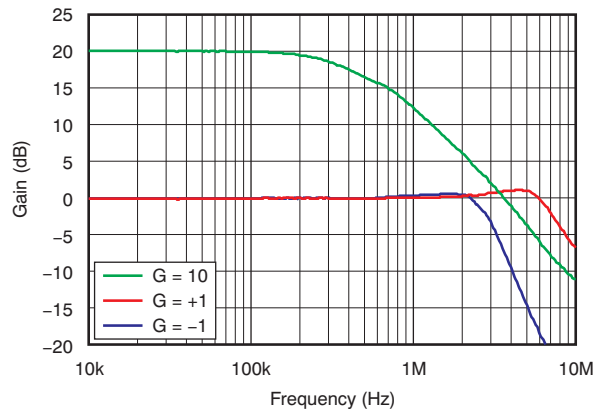

Figure 21. Closed-Loop Gain vs Frequency

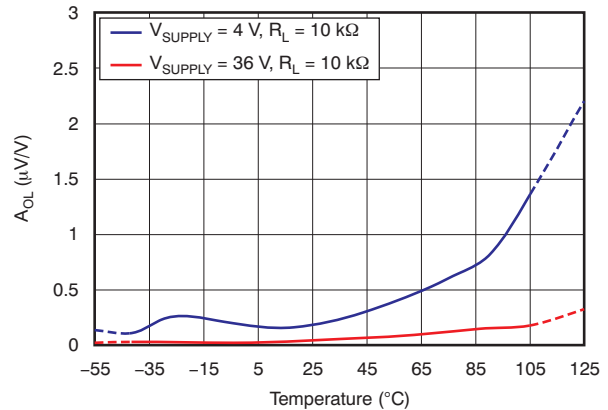

Figure 22. Open-Loop Gain vs Temperature

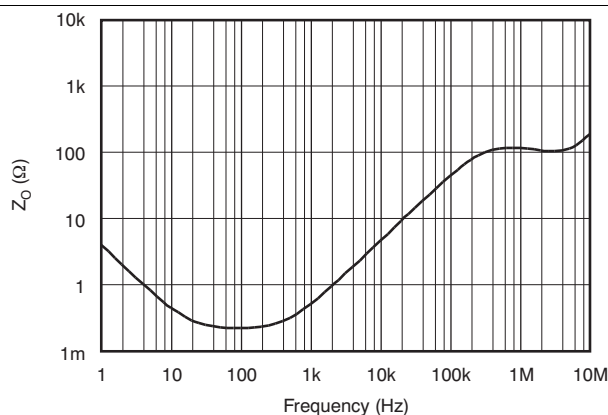

Figure 23. Open-Loop Output Impedance vs Frequency

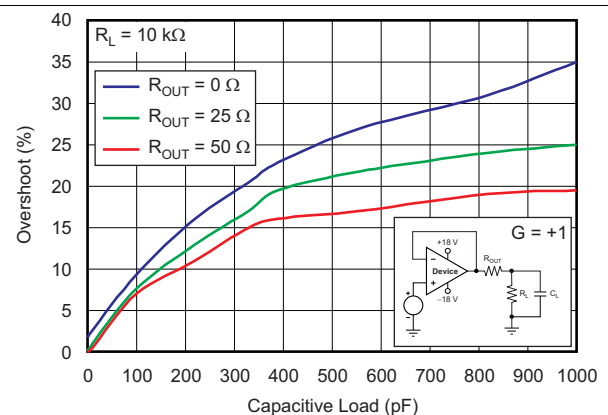

Figure 24. Small-Signal Overshoot vs Capacitive Load (100-mV Output Step)

Typical Characteristics (continued)

$V_S = \pm 18\text{ V}$ ,  $V_{CM} = V_S/2$ ,  $R_{LOAD} = 10\text{ k}\Omega$  connected to  $V_S/2$ , and  $C_L = 100\text{ pF}$ , unless otherwise noted.

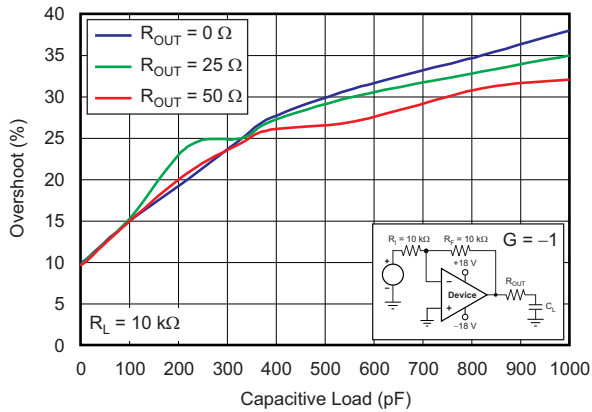

Figure 25. Small-Signal Overshoot vs Capacitive Load (100-mV Output Step)

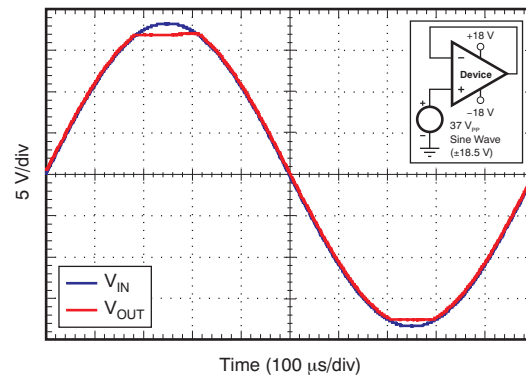

Figure 26. No Phase Reversal

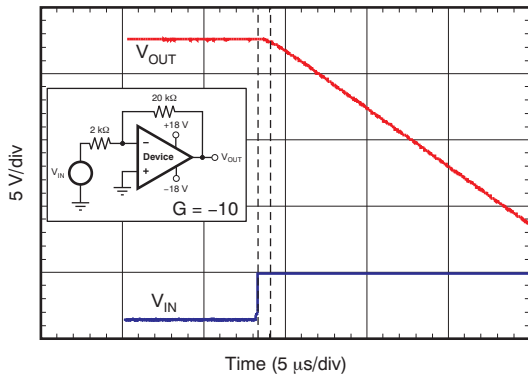

Figure 27. Positive Overload Recovery

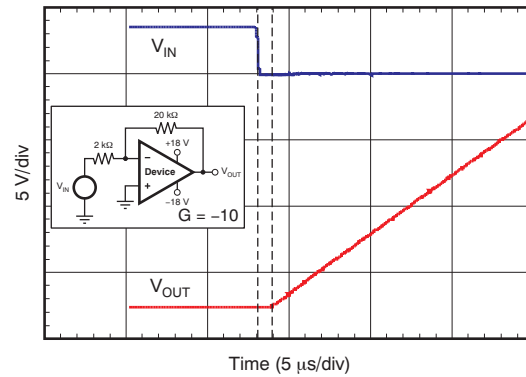

Figure 28. Negative Overload Recovery

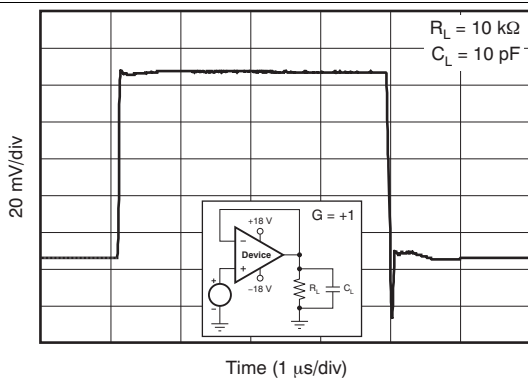

Figure 29. Small-Signal Step Response (100 mV)

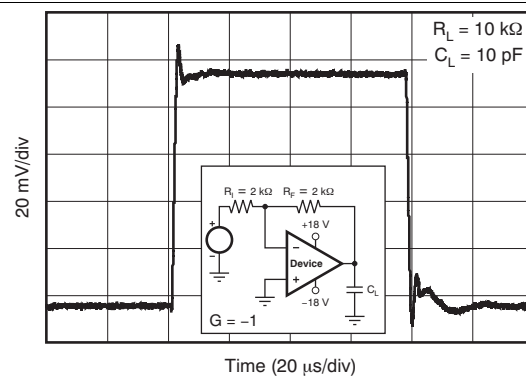

Figure 30. Small-Signal Step Response (100 mV)

Typical Characteristics (continued)

$V_S = \pm 18\text{ V}$ ,  $V_{CM} = V_S/2$ ,  $R_{LOAD} = 10\text{ k}\Omega$  connected to  $V_S/2$ , and  $C_L = 100\text{ pF}$ , unless otherwise noted.

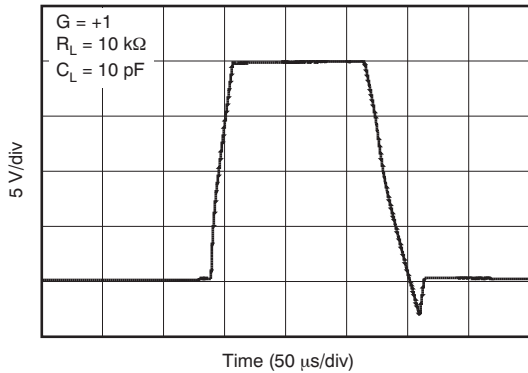

Figure 31. Large-Signal Step Response

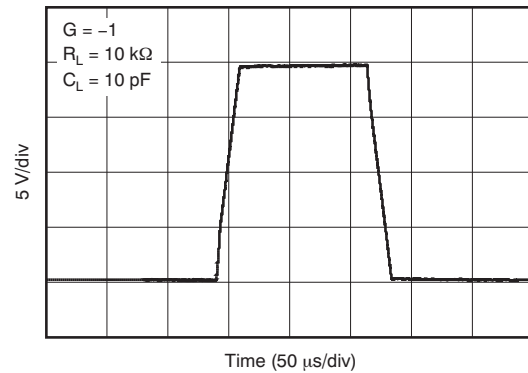

Figure 32. Large-Signal Step Response

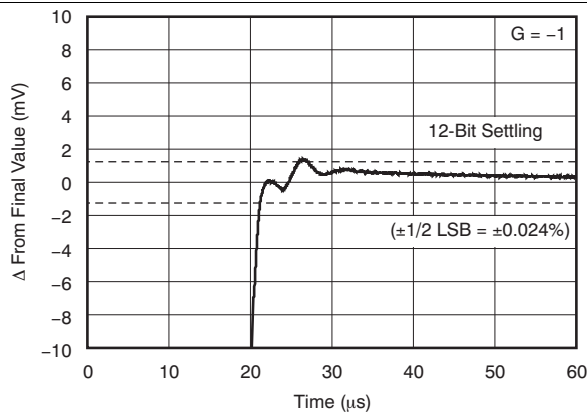

Figure 33. Large-Signal Settling Time (10-V Positive Step)

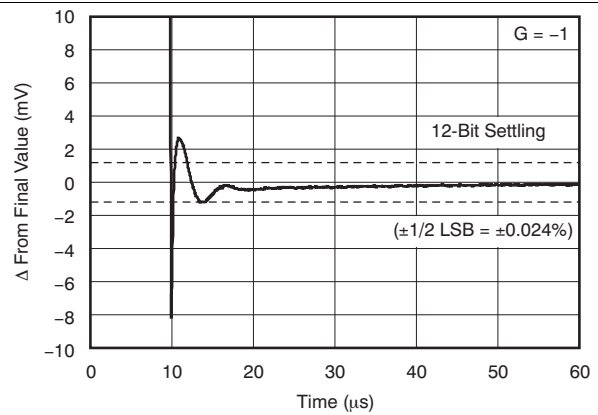

Figure 34. Large-Signal Settling Time (10-V Negative Step)

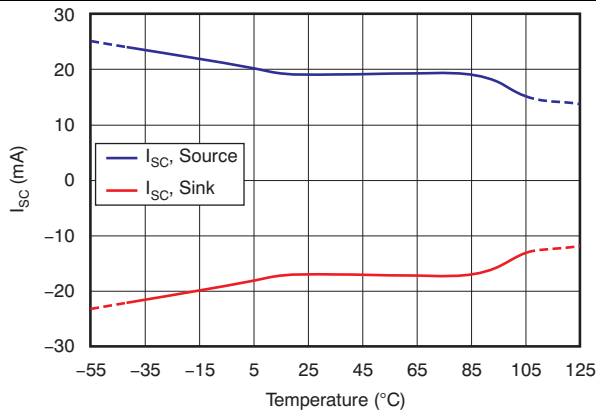

Figure 35. Short-Circuit Current vs Temperature

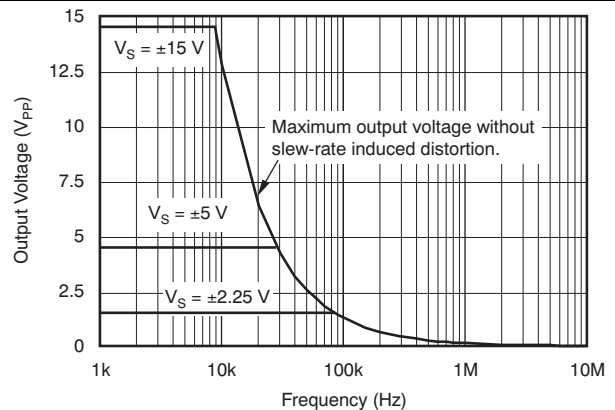

Figure 36. Maximum Output Voltage vs Frequency

### Typical Characteristics (continued)

$V_S = \pm 18\text{ V}$ ,  $V_{CM} = V_S/2$ ,  $R_{LOAD} = 10\text{ k}\Omega$  connected to  $V_S/2$ , and  $C_L = 100\text{ pF}$ , unless otherwise noted.

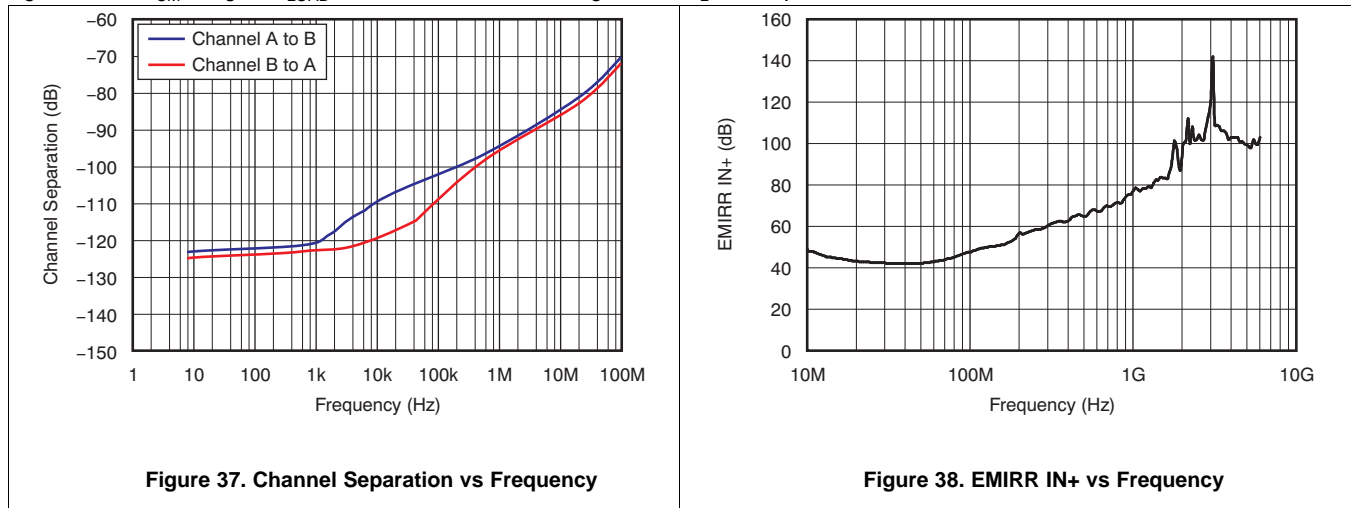

Figure 37. Channel Separation vs Frequency

Figure 38. EMIRR IN+ vs Frequency



## 8 Detailed Description

### 8.1 Overview

The OPA2188 operational amplifier combines precision offset and drift with excellent overall performance, making the device ideal for many precision applications. The precision offset drift of only  $0.085 \mu\text{V}/^\circ\text{C}$  provides stability over the entire temperature range. In addition, the device offers excellent overall performance with high CMRR, PSRR, and  $A_{OL}$ . As with all amplifiers, applications with noisy or high-impedance power supplies require decoupling capacitors close to the device pins. In most cases,  $0.1\text{-}\mu\text{F}$  capacitors are adequate.

### 8.2 Functional Block Diagram

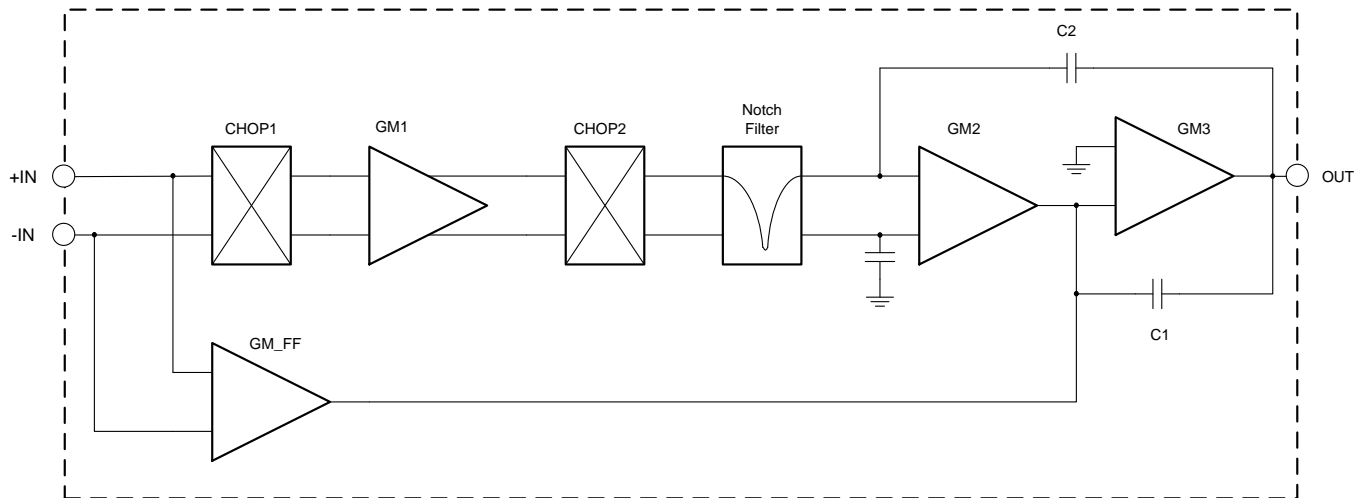

### 8.3 Feature Description

#### 8.3.1 Operating Characteristics

The OPA2188 is specified for operation from 4 V to 36 V ( $\pm 2$  V to  $\pm 18$  V). Many of the specifications apply from  $-40^{\circ}\text{C}$  to  $+105^{\circ}\text{C}$ . Parameters that can exhibit significant variance with regard to operating voltage or temperature are presented in the [Typical Characteristics](#).

#### 8.3.2 EMI Rejection

The OPA2188 uses integrated electromagnetic interference (EMI) filtering to reduce the effects of EMI interference from sources such as wireless communications and densely populated boards with a mix of analog signal chain and digital components. EMI immunity can be improved with circuit design techniques; the OPAx188 benefits from these design improvements. Texas Instruments has developed the ability to accurately measure and quantify the immunity of an operational amplifier over a broad frequency spectrum extending from 10 MHz to 6 GHz. [Figure 39](#) shows the results of this testing on the OPA2188. Detailed information can also be found in the application report *EMI Rejection Ratio of Operational Amplifiers (SBOA128)*, available for download from [the TI website](#).

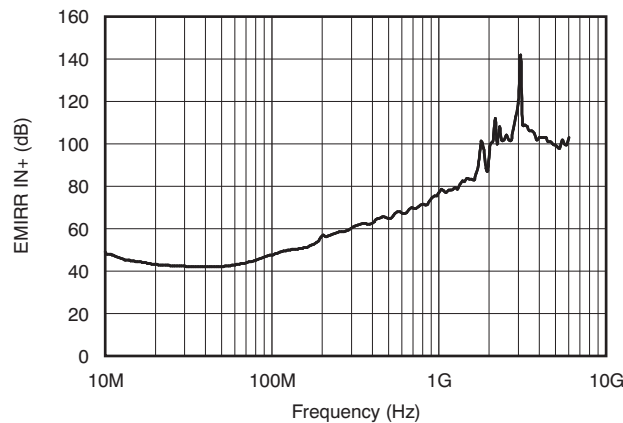

Figure 39. EMIRR Testing

#### 8.3.3 Phase-Reversal Protection

The OPA2188 device has an internal phase-reversal protection. Many op amps exhibit a phase reversal when the input is driven beyond its linear common-mode range. This condition is most often encountered in noninverting circuits when the input is driven beyond the specified common-mode voltage range, causing the output to reverse into the opposite rail. The OPA2188 input prevents phase reversal with excessive common-mode voltage. Instead, the output limits into the appropriate rail. This performance is shown in [Figure 40](#).

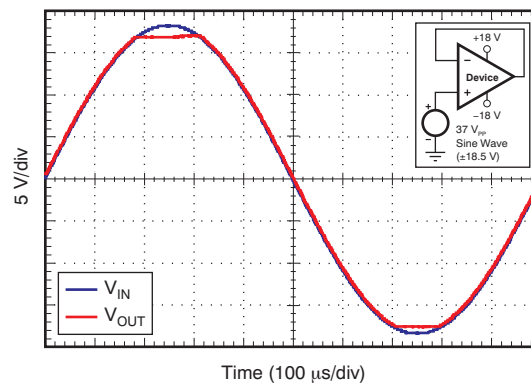
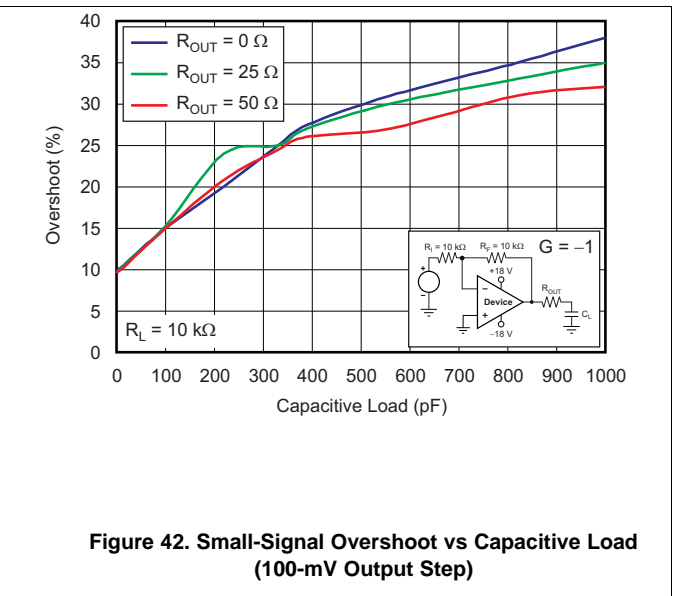
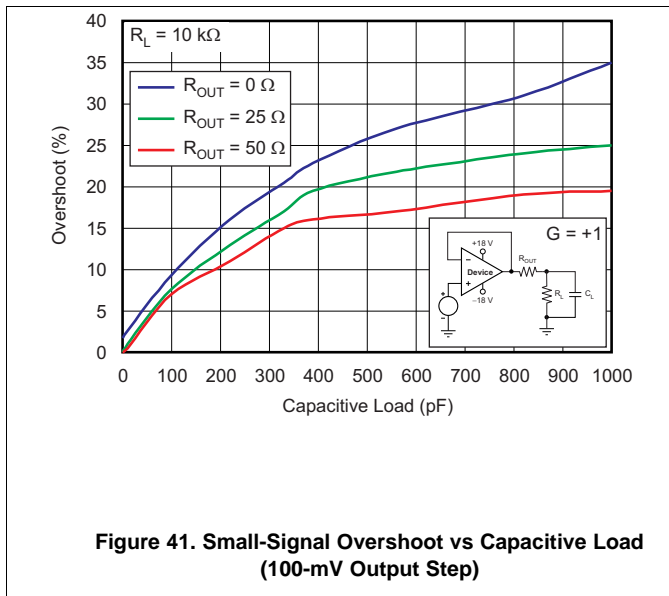

Figure 40. No Phase Reversal

## Feature Description (continued)

### 8.3.4 Capacitive Load and Stability

The dynamic characteristics of the OPA2188 have been optimized for a range of common operating conditions. The combination of low closed-loop gain and high capacitive loads decreases the phase margin of the amplifier and can lead to gain peaking or oscillations. As a result, heavier capacitive loads must be isolated from the output. The simplest way to achieve this isolation is to add a small resistor (for example,  $R_{OUT}$  equal to  $50\ \Omega$ ) in series with the output. Figure 41 and Figure 42 illustrate graphs of small-signal overshoot versus capacitive load for several values of  $R_{OUT}$ . Also, refer to the applications report, *Feedback Plots Define Op Amp AC Performance (SBOA015)*, available for download from the TI website, for details of analysis techniques and application circuits.



### 8.3.5 Electrical Overstress

Designers often ask questions about the capability of an operational amplifier to withstand electrical overstress. These questions tend to focus on the device inputs, but may involve the supply voltage pins or even the output pin. Each of these different pin functions have electrical stress limits determined by the voltage breakdown characteristics of the particular semiconductor fabrication process and specific circuits connected to the pin. Additionally, internal electrostatic discharge (ESD) protection is built into these circuits to protect them from accidental ESD events both before and during product assembly.

These ESD protection diodes also provide in-circuit, input overdrive protection, as long as the current is limited to 10 mA as stated in the *Absolute Maximum Ratings*. Figure 43 shows how a series input resistor may be added to the driven input to limit the input current. The added resistor contributes thermal noise at the amplifier input and its value should be kept to a minimum in noise-sensitive applications.

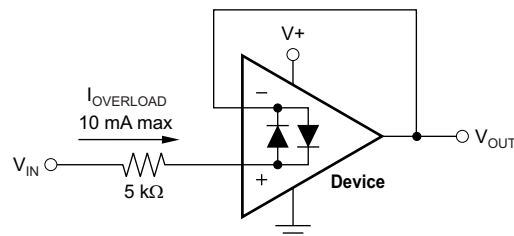

**Figure 43. Input Current Protection**

## Feature Description (continued)

An ESD event produces a short duration, high-voltage pulse that is transformed into a short duration, high-current pulse as it discharges through a semiconductor device. The ESD protection circuits are designed to provide a current path around the operational amplifier core to prevent it from being damaged. The energy absorbed by the protection circuitry is then dissipated as heat.

When the operational amplifier connects into a circuit, the ESD protection components are intended to remain inactive and not become involved in the application circuit operation. However, circumstances may arise where an applied voltage exceeds the operating voltage range of a given pin. Should this condition occur, there is a risk that some of the internal ESD protection circuits may be biased on, and conduct current. Any such current flow occurs through ESD cells and rarely involves the absorption device.

If there is an uncertainty about the ability of the supply to absorb this current, external zener diodes may be added to the supply pins. The zener voltage must be selected such that the diode does not turn on during normal operation.

However, its zener voltage must be low enough so that the zener diode conducts if the supply pin begins to rise above the safe operating supply voltage level.

## 8.4 Device Functional Modes

The OPA2188 device has a single functional mode. The device is powered on as long as the power supply voltage is between 4 V ( $\pm 2$  V) and 36 V ( $\pm 18$  V).

## 9 Application and Implementation

### NOTE

Information in the following applications sections is not part of the TI component specification, and TI does not warrant its accuracy or completeness. TI's customers are responsible for determining suitability of components for their purposes. Customers should validate and test their design implementation to confirm system functionality.

### 9.1 Application Information

### 9.2 Typical Applications

#### 9.2.1 High-Side Voltage-to-Current (V-I) Converter

The circuit shown in Figure 44 is a high-side voltage-to-current (V-I) converter. It translates an input voltage of 0 V to 2 V to an output current of 0 mA to 100 mA. Figure 45 shows the measured transfer function for this circuit. The low offset voltage and offset drift of the OPA2188 facilitate excellent dc accuracy for the circuit.

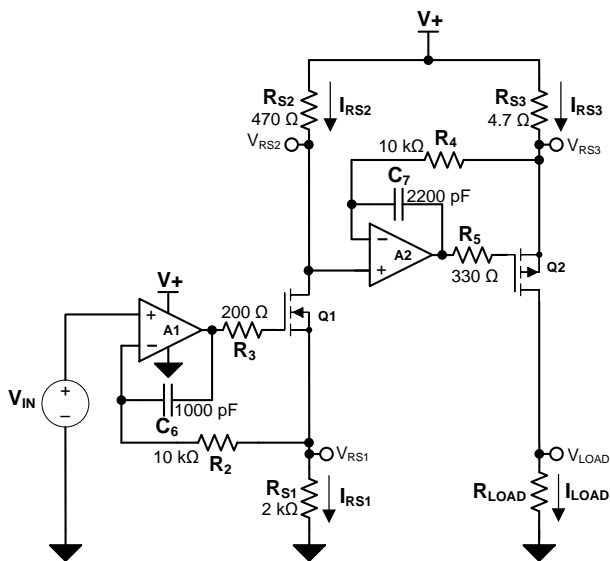

Copyright © 2016, Texas Instruments Incorporated

Figure 44. High-Side Voltage-to-Current (V-I) Converter

## Typical Applications (continued)

### 9.2.1.1 Design Requirements

The design requirements are as follows:

- Supply Voltage: 5 V DC
- Input: 0 V to 2 V DC
- Output: 0 mA to 100 mA DC

### 9.2.1.2 Detailed Design Procedure

The V-I transfer function of the circuit is based on the relationship between the input voltage,  $V_{IN}$ , and the three current sensing resistors,  $R_{S1}$ ,  $R_{S2}$ , and  $R_{S3}$ . The relationship between  $V_{IN}$  and  $R_{S1}$  determines the current that flows through the first stage of the design. The current gain from the first stage to the second stage is based on the relationship between  $R_{S2}$  and  $R_{S3}$ .

For a successful design, pay close attention to the dc characteristics of the operational amplifier chosen for the application. To meet the performance goals, this application benefits from an operational amplifier with low offset voltage, low temperature drift, and rail-to-rail output. The OPA2188 CMOS operational amplifier is a high-precision, ultra-low offset, ultra-low drift amplifier optimized for low-voltage, single-supply operation with an output swing to within 15 mV of the positive rail. The OPA2188 family uses chopping techniques to provide low initial offset voltage and near-zero drift over time and temperature. Low offset voltage and low drift reduce the offset error in the system, making these devices appropriate for precise dc control. The rail-to-rail output stage of the OPA2188 ensures that the output swing of the operational amplifier is able to fully control the gate of the MOSFET devices within the supply rails.

A detailed error analysis, design procedure, and additional measured results are given in [TIPD102](#).

### 9.2.1.3 Application Curve

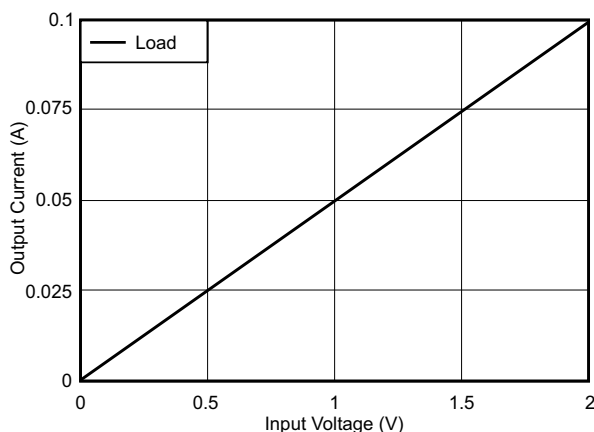

**Figure 45. Measured Transfer Function for High-Side V-I Converter**

## 9.3 System Examples

### 9.3.1 Discrete INA + Attenuation for ADC With 3.3-V Supply

The application examples of [Figure 46](#) and [Figure 47](#) highlight only a few of the circuits where the OPA2188 can be used.

System Examples (continued)

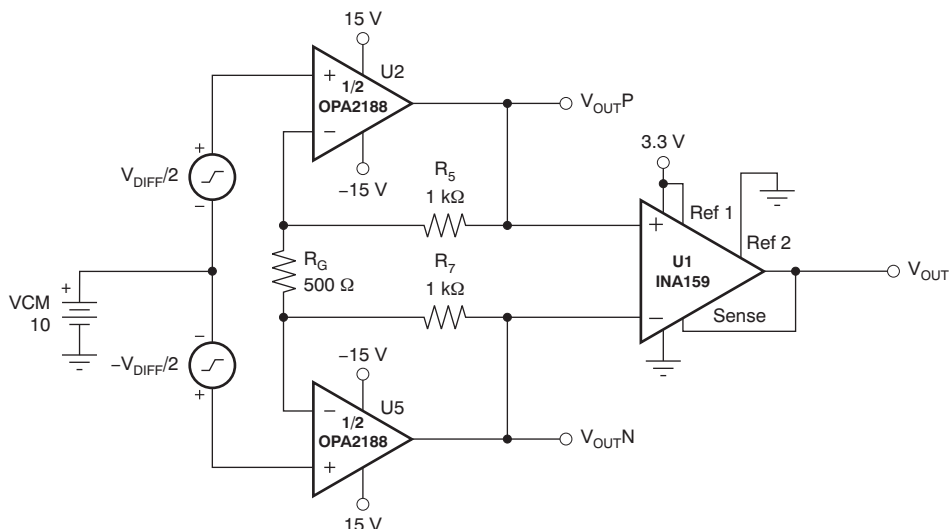
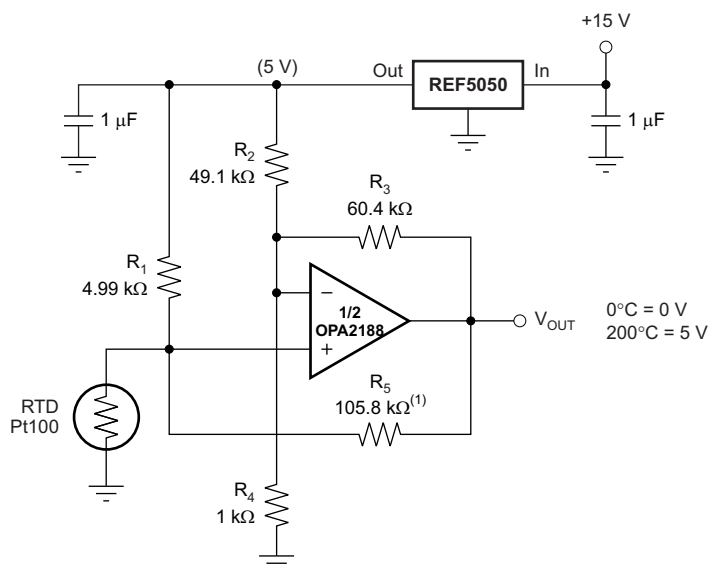

Figure 46. Discrete INA + Attenuation for ADC with 3.3-V Supply

9.3.2 RTD Amplifier with Linearization



(1) R<sub>5</sub> provides positive-varying excitation to linearize output.

Figure 47. RTD Amplifier with Linearization

10 Power Supply Recommendations

The OPA2188 is specified for operation from 4 V to 36 V ( $\pm 2$  V to  $\pm 18$  V); many specifications apply from  $-40^{\circ}\text{C}$  to  $105^{\circ}\text{C}$ . The *Typical Characteristics* presents parameters that can exhibit significant variance with regard to operating voltage or temperature.

**CAUTION**

Supply voltages larger than 40 V can permanently damage the device (see the [Absolute Maximum Ratings](#)).

TI recommends placing 0.1- $\mu$ F bypass capacitors close to the power-supply pins to reduce errors coupling in from noisy or high-impedance power supplies. For more detailed information on bypass capacitor placement, refer to the [Layout Guidelines](#) section.



## 11 Layout

### 11.1 Layout Guidelines

Pay attention to good layout practices. Keep traces short and when possible, use a printed-circuit-board (PCB) ground plane with surface-mount components placed as close to the device pins as possible. Place a 0.1- $\mu$ F capacitor closely across the supply pins. Apply these guidelines throughout the analog circuit to improve performance and provide benefits, such as reducing the electromagnetic interference (EMI) susceptibility.

Operational amplifiers vary in susceptibility to radio frequency interference (RFI). RFI can generally be identified as a variation in offset voltage or DC signal levels with changes in the interfering RF signal. The OPA2188 is specifically designed to minimize susceptibility to RFI and demonstrates remarkably low sensitivity compared to previous generation devices. Strong RF fields may still cause varying offset levels.

### 11.2 Layout Example

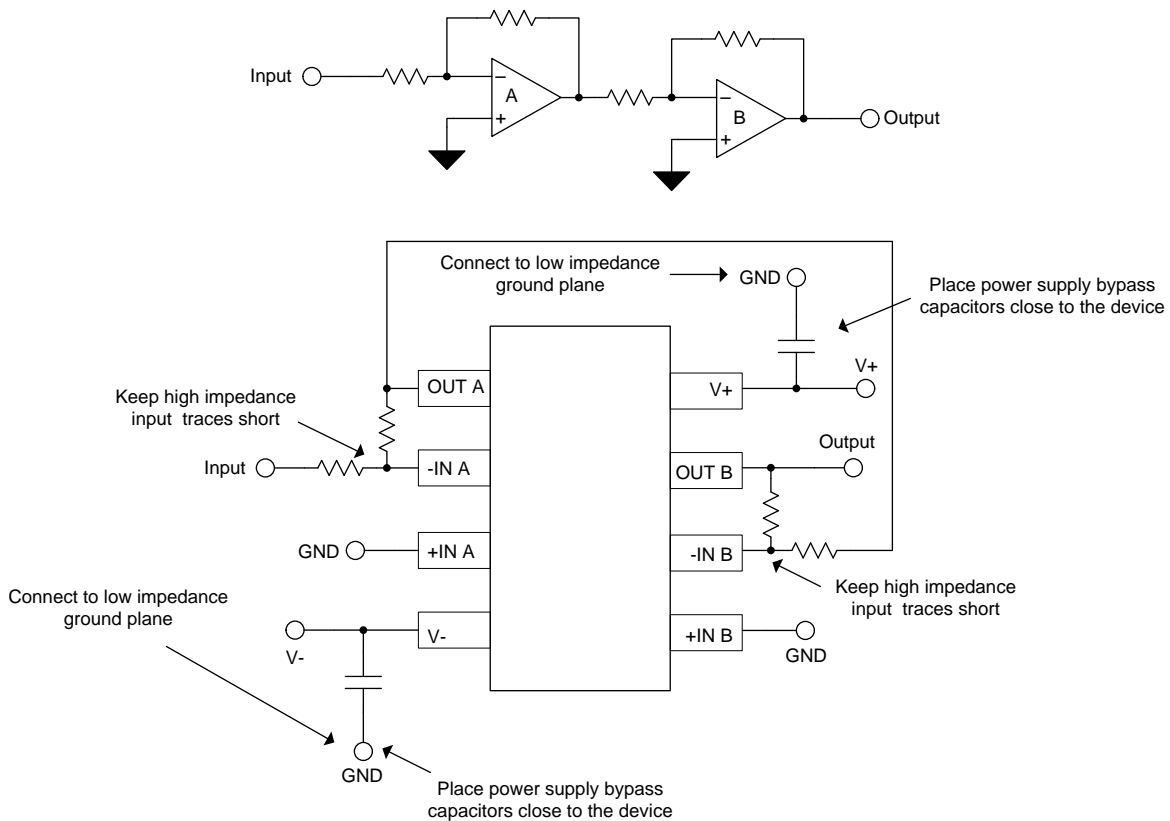

Copyright © 2016, Texas Instruments Incorporated

**Figure 48. Layout Example**

## 12 Device and Documentation Support

### 12.1 Device Support

#### 12.1.1 Development Support

##### 12.1.1.1 TINA-TI™ (Free Software Download)

TINA™ is a simple, powerful, and easy-to-use circuit simulation program based on a SPICE engine. TINA-TI™ is a free, fully-functional version of the TINA software, preloaded with a library of macro models in addition to a range of both passive and active models. TINA-TI provides all the conventional dc, transient, and frequency domain analysis of SPICE, as well as additional design capabilities.

Available as a [free download](#) from the Analog eLab Design Center, TINA-TI offers extensive post-processing capability that allows users to format results in a variety of ways. Virtual instruments offer the ability to select input waveforms and probe circuit nodes, voltages, and waveforms, creating a dynamic quick-start tool.

---

#### NOTE

These files require that either the TINA software (from DesignSoft™) or TINA-TI software be installed. Download the free TINA-TI software from the [TINA-TI folder](#).

---

##### 12.1.1.2 DIP Adapter EVM

The [DIP Adapter EVM](#) tool provides an easy, low-cost way to prototype small surface mount ICs. The evaluation tool these TI packages: D or U (SOIC-8), PW (TSSOP-8), DGK (MSOP-8), DBV (SOT23-6, SOT23-5 and SOT23-3), DCK (SC70-6 and SC70-5), and DRL (SOT563-6). The DIP Adapter EVM may also be used with terminal strips or may be wired directly to existing circuits.

##### 12.1.1.3 Universal Op Amp EVM

The [Universal Op Amp EVM](#) is a series of general-purpose, blank circuit boards that simplify prototyping circuits for a variety of IC package types. The evaluation module board design allows many different circuits to be constructed easily and quickly. Five models are offered, with each model intended for a specific package type. PDIP, SOIC, MSOP, TSSOP and SOT23 packages are all supported.

---

#### NOTE

These boards are unpopulated, so users must provide their own ICs. TI recommends requesting several op amp device samples when ordering the Universal Op Amp EVM.

---

##### 12.1.1.4 TI Precision Designs

TI Precision Designs are analog solutions created by TI's precision analog applications experts and offer the theory of operation, component selection, simulation, complete PCB schematic and layout, bill of materials, and measured performance of many useful circuits. TI Precision Designs are available online at <http://www.ti.com/ww/en/analog/precision-designs/>.

##### 12.1.1.5 WEBENCH® Filter Designer

[WEBENCH® Filter Designer](#) is a simple, powerful, and easy-to-use active filter design program. The WEBENCH Filter Designer lets you create optimized filter designs using a selection of TI operational amplifiers and passive components from TI's vendor partners.

Available as a web-based tool from the WEBENCH® Design Center, [WEBENCH® Filter Designer](#) allows you to design, optimize, and simulate complete multistage active filter solutions within minutes.

## 12.2 Documentation Support

### 12.2.1 Related Documentation

The following documents are relevant to using the OPA2188, and recommended for reference. All are available for download at [www.ti.com](http://www.ti.com) unless otherwise noted.

- [EMI Rejection Ratio of Operational Amplifiers.](#)
- [Feedback Plots Define Op Amp AC Performance](#)
- [Op Amp Performance Analysis.](#)
- [Single-Supply Operation of Operational Amplifiers](#)
- [Tuning in Amplifiers.](#)

### 12.3 Receiving Notification of Documentation Updates

To receive notification of documentation updates, navigate to the device product folder on [ti.com](http://ti.com). In the upper right corner, click on *Alert me* to register and receive a weekly digest of any product information that has changed. For change details, review the revision history included in any revised document.

### 12.4 Community Resource

The following links connect to TI community resources. Linked contents are provided "AS IS" by the respective contributors. They do not constitute TI specifications and do not necessarily reflect TI's views; see TI's [Terms of Use](#).

**TI E2E™ Online Community** *TI's Engineer-to-Engineer (E2E) Community*. Created to foster collaboration among engineers. At [e2e.ti.com](http://e2e.ti.com), you can ask questions, share knowledge, explore ideas and help solve problems with fellow engineers.

**Design Support** *TI's Design Support* Quickly find helpful E2E forums along with design support tools and contact information for technical support.

### 12.5 Trademarks

TINA-TI, E2E are trademarks of Texas Instruments.  
 WEBENCH is a registered trademark of Texas Instruments.  
 TINA, DesignSoft are trademarks of DesignSoft, Inc.  
 All other trademarks are the property of their respective owners.

### 12.6 Electrostatic Discharge Caution



This integrated circuit can be damaged by ESD. Texas Instruments recommends that all integrated circuits be handled with appropriate precautions. Failure to observe proper handling and installation procedures can cause damage.

ESD damage can range from subtle performance degradation to complete device failure. Precision integrated circuits may be more susceptible to damage because very small parametric changes could cause the device not to meet its published specifications.

### 12.7 Glossary

[SLYZ022](#) — *TI Glossary*.

This glossary lists and explains terms, acronyms, and definitions.

## 13 Mechanical, Packaging, and Orderable Information

The following pages include mechanical, packaging, and orderable information. This information is the most current data available for the designated devices. This data is subject to change without notice and revision of this document. For browser-based versions of this data sheet, refer to the left-hand navigation.

**PACKAGING INFORMATION**

| Orderable Device | Status<br>(1) | Package Type | Package Drawing | Pins | Package Qty | Eco Plan<br>(2)         | Lead/Ball Finish<br>(6)    | MSL Peak Temp<br>(3) | Op Temp (°C) | Device Marking<br>(4/5) | Samples                 |
|------------------|---------------|--------------|-----------------|------|-------------|-------------------------|----------------------------|----------------------|--------------|-------------------------|-------------------------|
| OPA2188AID       | ACTIVE        | SOIC         | D               | 8    | 75          | Green (RoHS & no Sb/Br) | CU NIPDAU                  | Level-2-260C-1 YEAR  | -40 to 105   | (2188 ~ OPA2188)        | <a href="#">Samples</a> |
| OPA2188AIDGKR    | ACTIVE        | VSSOP        | DGK             | 8    | 2500        | Green (RoHS & no Sb/Br) | CU NIPDAU  <br>CU NIPDAUAG | Level-2-260C-1 YEAR  | -40 to 105   | 2188                    | <a href="#">Samples</a> |
| OPA2188AIDGKT    | ACTIVE        | VSSOP        | DGK             | 8    | 250         | Green (RoHS & no Sb/Br) | CU NIPDAU  <br>CU NIPDAUAG | Level-2-260C-1 YEAR  | -40 to 105   | 2188                    | <a href="#">Samples</a> |
| OPA2188AIDR      | ACTIVE        | SOIC         | D               | 8    | 2500        | Green (RoHS & no Sb/Br) | CU NIPDAU                  | Level-2-260C-1 YEAR  | -40 to 105   | (2188 ~ OPA2188)        | <a href="#">Samples</a> |

(1) The marketing status values are defined as follows:

**ACTIVE:** Product device recommended for new designs.

**LIFEBUY:** TI has announced that the device will be discontinued, and a lifetime-buy period is in effect.

**NRND:** Not recommended for new designs. Device is in production to support existing customers, but TI does not recommend using this part in a new design.

**PREVIEW:** Device has been announced but is not in production. Samples may or may not be available.

**OBSOLETE:** TI has discontinued the production of the device.

(2) Eco Plan - The planned eco-friendly classification: Pb-Free (RoHS), Pb-Free (RoHS Exempt), or Green (RoHS & no Sb/Br) - please check <http://www.ti.com/productcontent> for the latest availability information and additional product content details.

**TBD:** The Pb-Free/Green conversion plan has not been defined.

**Pb-Free (RoHS):** TI's terms "Lead-Free" or "Pb-Free" mean semiconductor products that are compatible with the current RoHS requirements for all 6 substances, including the requirement that lead not exceed 0.1% by weight in homogeneous materials. Where designed to be soldered at high temperatures, TI Pb-Free products are suitable for use in specified lead-free processes.

**Pb-Free (RoHS Exempt):** This component has a RoHS exemption for either 1) lead-based flip-chip solder bumps used between the die and package, or 2) lead-based die adhesive used between the die and leadframe. The component is otherwise considered Pb-Free (RoHS compatible) as defined above.

**Green (RoHS & no Sb/Br):** TI defines "Green" to mean Pb-Free (RoHS compatible), and free of Bromine (Br) and Antimony (Sb) based flame retardants (Br or Sb do not exceed 0.1% by weight in homogeneous material)

(3) MSL, Peak Temp. - The Moisture Sensitivity Level rating according to the JEDEC industry standard classifications, and peak solder temperature.

(4) There may be additional marking, which relates to the logo, the lot trace code information, or the environmental category on the device.

(5) Multiple Device Markings will be inside parentheses. Only one Device Marking contained in parentheses and separated by a "~" will appear on a device. If a line is indented then it is a continuation of the previous line and the two combined represent the entire Device Marking for that device.

(6) Lead/Ball Finish - Orderable Devices may have multiple material finish options. Finish options are separated by a vertical ruled line. Lead/Ball Finish values may wrap to two lines if the finish value exceeds the maximum column width.

**Important Information and Disclaimer:** The information provided on this page represents TI's knowledge and belief as of the date that it is provided. TI bases its knowledge and belief on information provided by third parties, and makes no representation or warranty as to the accuracy of such information. Efforts are underway to better integrate information from third parties. TI has taken and continues to take reasonable steps to provide representative and accurate information but may not have conducted destructive testing or chemical analysis on incoming materials and chemicals. TI and TI suppliers consider certain information to be proprietary, and thus CAS numbers and other limited information may not be available for release.

In no event shall TI's liability arising out of such information exceed the total purchase price of the TI part(s) at issue in this document sold by TI to Customer on an annual basis.

**TAPE AND REEL INFORMATION**

**QUADRANT ASSIGNMENTS FOR PIN 1 ORIENTATION IN TAPE**

\*All dimensions are nominal

| Device        | Package Type | Package Drawing | Pins | SPQ  | Reel Diameter (mm) | Reel Width W1 (mm) | A0 (mm) | B0 (mm) | K0 (mm) | P1 (mm) | W (mm) | Pin1 Quadrant |
|---------------|--------------|-----------------|------|------|--------------------|--------------------|---------|---------|---------|---------|--------|---------------|
| OPA2188AIDGKR | VSSOP        | DGK             | 8    | 2500 | 330.0              | 12.4               | 5.3     | 3.4     | 1.4     | 8.0     | 12.0   | Q1            |
| OPA2188AIDGKR | VSSOP        | DGK             | 8    | 2500 | 330.0              | 12.4               | 5.3     | 3.4     | 1.4     | 8.0     | 12.0   | Q1            |
| OPA2188AIDGKT | VSSOP        | DGK             | 8    | 250  | 177.8              | 12.4               | 5.3     | 3.4     | 1.4     | 8.0     | 12.0   | Q1            |
| OPA2188AIDGKT | VSSOP        | DGK             | 8    | 250  | 330.0              | 12.4               | 5.3     | 3.4     | 1.4     | 8.0     | 12.0   | Q1            |
| OPA2188AIDR   | SOIC         | D               | 8    | 2500 | 330.0              | 12.4               | 6.4     | 5.2     | 2.1     | 8.0     | 12.0   | Q1            |

**TAPE AND REEL BOX DIMENSIONS**

\*All dimensions are nominal

| Device        | Package Type | Package Drawing | Pins | SPQ  | Length (mm) | Width (mm) | Height (mm) |
|---------------|--------------|-----------------|------|------|-------------|------------|-------------|
| OPA2188AIDGKR | VSSOP        | DGK             | 8    | 2500 | 346.0       | 346.0      | 41.0        |
| OPA2188AIDGKR | VSSOP        | DGK             | 8    | 2500 | 366.0       | 364.0      | 50.0        |
| OPA2188AIDGKT | VSSOP        | DGK             | 8    | 250  | 223.0       | 270.0      | 35.0        |
| OPA2188AIDGKT | VSSOP        | DGK             | 8    | 250  | 366.0       | 364.0      | 50.0        |
| OPA2188AIDR   | SOIC         | D               | 8    | 2500 | 367.0       | 367.0      | 35.0        |



D0008A

# PACKAGE OUTLINE

SOIC - 1.75 mm max height

SMALL OUTLINE INTEGRATED CIRCUIT



4214825/C 02/2019

## NOTES:

- Linear dimensions are in inches [millimeters]. Dimensions in parenthesis are for reference only. Controlling dimensions are in inches. Dimensioning and tolerancing per ASME Y14.5M.
- This drawing is subject to change without notice.
- This dimension does not include mold flash, protrusions, or gate burrs. Mold flash, protrusions, or gate burrs shall not exceed  $.006$  [0.15] per side.
- This dimension does not include interlead flash.
- Reference JEDEC registration MS-012, variation AA.



# EXAMPLE BOARD LAYOUT

D0008A

SOIC - 1.75 mm max height

SMALL OUTLINE INTEGRATED CIRCUIT



LAND PATTERN EXAMPLE  
 EXPOSED METAL SHOWN  
 SCALE:8X



SOLDER MASK DETAILS

4214825/C 02/2019

NOTES: (continued)

- 6. Publication IPC-7351 may have alternate designs.
- 7. Solder mask tolerances between and around signal pads can vary based on board fabrication site.

# EXAMPLE STENCIL DESIGN

D0008A

SOIC - 1.75 mm max height

SMALL OUTLINE INTEGRATED CIRCUIT



SOLDER PASTE EXAMPLE  
BASED ON .005 INCH [0.125 MM] THICK STENCIL  
SCALE:8X

4214825/C 02/2019

NOTES: (continued)

8. Laser cutting apertures with trapezoidal walls and rounded corners may offer better paste release. IPC-7525 may have alternate design recommendations.
9. Board assembly site may have different recommendations for stencil design.





- NOTES:
- A. All linear dimensions are in millimeters.
  - B. This drawing is subject to change without notice.
  - C. Publication IPC-7351 is recommended for alternate designs.
  - D. Laser cutting apertures with trapezoidal walls and also rounding corners will offer better paste release. Customers should contact their board assembly site for stencil design recommendations. Refer to IPC-7525 for other stencil recommendations.
  - E. Customers should contact their board fabrication site for solder mask tolerances between and around signal pads.

## IMPORTANT NOTICE AND DISCLAIMER

TI PROVIDES TECHNICAL AND RELIABILITY DATA (INCLUDING DATASHEETS), DESIGN RESOURCES (INCLUDING REFERENCE DESIGNS), APPLICATION OR OTHER DESIGN ADVICE, WEB TOOLS, SAFETY INFORMATION, AND OTHER RESOURCES "AS IS" AND WITH ALL FAULTS, AND DISCLAIMS ALL WARRANTIES, EXPRESS AND IMPLIED, INCLUDING WITHOUT LIMITATION ANY IMPLIED WARRANTIES OF MERCHANTABILITY, FITNESS FOR A PARTICULAR PURPOSE OR NON-INFRINGEMENT OF THIRD PARTY INTELLECTUAL PROPERTY RIGHTS.

These resources are intended for skilled developers designing with TI products. You are solely responsible for (1) selecting the appropriate TI products for your application, (2) designing, validating and testing your application, and (3) ensuring your application meets applicable standards, and any other safety, security, or other requirements. These resources are subject to change without notice. TI grants you permission to use these resources only for development of an application that uses the TI products described in the resource. Other reproduction and display of these resources is prohibited. No license is granted to any other TI intellectual property right or to any third party intellectual property right. TI disclaims responsibility for, and you will fully indemnify TI and its representatives against, any claims, damages, costs, losses, and liabilities arising out of your use of these resources.

TI's products are provided subject to TI's Terms of Sale ([www.ti.com/legal/termsofsale.html](http://www.ti.com/legal/termsofsale.html)) or other applicable terms available either on [ti.com](http://ti.com) or provided in conjunction with such TI products. TI's provision of these resources does not expand or otherwise alter TI's applicable warranties or warranty disclaimers for TI products.

Mailing Address: Texas Instruments, Post Office Box 655303, Dallas, Texas 75265  
Copyright © 2019, Texas Instruments Incorporated