



Low-Power, Precision SINGLE-SUPPLY OPERATIONAL AMPLIFIERS

FEATURES

- **WIDE SUPPLY RANGE:**
Single Supply: $V_S = +2.7V$ to $+36V$
Dual Supply: $V_S = \pm 1.35V$ to $\pm 18V$
- **SPECIFIED PERFORMANCE:**
 $+2.7V$, $+5V$, and $\pm 15V$
- **LOW QUIESCENT CURRENT:** $250\mu A/amp$
- **LOW INPUT BIAS CURRENT:** $25nA$ max
- **LOW OFFSET VOLTAGE:** $100\mu V$ max
- **HIGH CMRR, PSRR, and A_{OL}**
- **SINGLE, DUAL, and QUAD VERSIONS**

DESCRIPTION

The OPA234 series low-cost op amps are ideal for single-supply, low-voltage, low-power applications. The series provides lower quiescent current than older "1013"-type products and comes in current industry-standard packages and pinouts. The combination of low offset voltage, high common-mode rejection, high power-supply rejection, and a wide supply range provides excellent accuracy and versatility. Single, dual, and quad versions have identical specifications for maximum design flexibility. These general-purpose op amps are ideal for portable and battery-powered applications.

The OPA234 series op amps operate from either single or dual supplies. In single-supply operation, the input common-mode range extends below ground and the output can swing to within 50mV of ground. Excellent phase margin makes the OPA234 series ideal for demanding applications, including high load capacitance. Dual and quad designs feature completely independent circuitry for lowest crosstalk and freedom from interaction.

Single version packages are in an SO-8 surface-mount and a space-saving MSOP-8 surface-mount. Dual packages are in an SO-8 surface-mount. Quad packages are in an SO-14 surface-mount. All are specified for $-40^\circ C$ to $+85^\circ C$ operation.

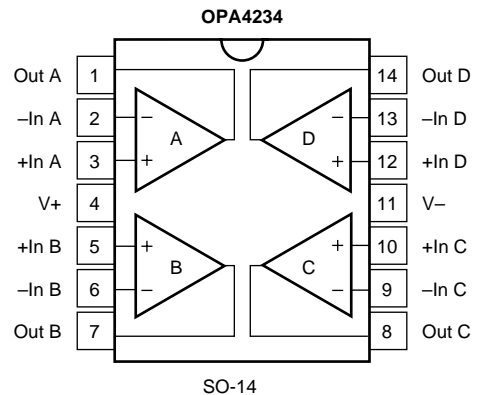
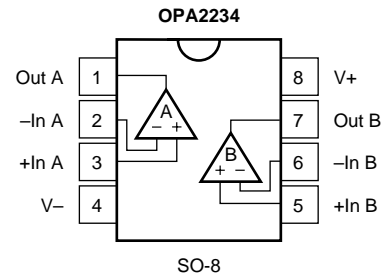
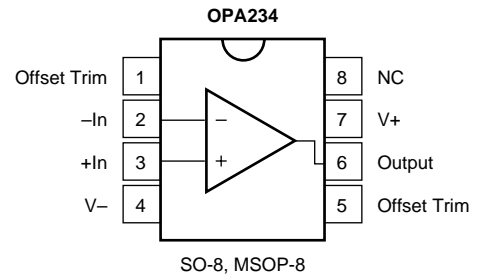

Please be aware that an important notice concerning availability, standard warranty, and use in critical applications of Texas Instruments semiconductor products and disclaimers thereto appears at the end of this data sheet.

All trademarks are the property of their respective owners.

ELECTRICAL CHARACTERISTICS: $V_S = +2.7V$

At $T_A = 25^\circ C$, $V_S = +2.7V$, $R_L = 10k\Omega$ connected to $V_S/2$, and $V_{OUT} = V_S/2$, unless otherwise noted.

| PARAMETER | CONDITION | OPA234U, E OPA2234U | | | OPA234UA, EA OPA2234UA OPA4234UA, U | | | UNITS |
|---|---------------|--|------------|-----------------------|---|-----------|-----------|-----------------------|
| | | MIN | TYP | MAX | MIN | TYP | MAX | |
| OFFSET VOLTAGE | | | | | | | | |
| Input Offset Voltage OPA234E, EA | V_{OS} | | ± 40 | ± 100 | | * | ± 250 | μV |
| vs Temperature ⁽¹⁾ | dV_{OS}/dT | | ± 100 | ± 150 | | * | ± 350 | μV |
| vs Power Supply | PSRR | | ± 0.5 | ± 3 | | * | * | $\mu V/^\circ C$ |
| vs Time | | | 3 | 10 | | * | 20 | $\mu V/V$ |
| Channel Separation (Dual, Quad) | | | 0.2 | | | * | | $\mu V/mo$ |
| | | | 0.3 | | | * | | $\mu V/V$ |
| INPUT BIAS CURRENT | | | | | | | | |
| Input Bias Current ⁽²⁾ | I_B | $V_{CM} = 1.35V$ | -15 | -30 | | * | -50 | nA |
| Input Offset Current | I_{OS} | $V_{CM} = 1.35V$ | ± 1 | ± 5 | | * | * | n |
| NOISE | | $f = 1kHz$ | | | | | | |
| Input Voltage Noise Density | V_n | | 25 | | | * | | nV/\sqrt{Hz} |
| Current Noise Density | i_n | | 80 | | | * | | fA/\sqrt{Hz} |
| INPUT VOLTAGE RANGE | | | | | | | | |
| Common-Mode Voltage Range | | | -0.1 | | $(V+) - 1$ | * | * | V |
| Common-Mode Rejection | CMRR | $V_{CM} = -0.1V$ to $1.7V$ | 91 | 106 | | * | * | dB |
| INPUT IMPEDANCE | | | | | | | | |
| Differential | | $V_{CM} = 1.35V$ | | $10^7 \parallel 5$ | | * | | $\Omega \parallel pF$ |
| Common-Mode | | | | $10^{10} \parallel 6$ | | * | | $\Omega \parallel pF$ |
| OPEN-LOOP GAIN | | | | | | | | |
| Open-Loop Voltage Gain | A_{OL} | $V_O = 0.25V$ to $1.7V$ $R_L = 10k\Omega$ $R_L = 2k\Omega$ | 108 86 | 125 96 | | 100 86 | * | dB dB |
| FREQUENCY RESPONSE | | | | | | | | |
| Gain-Bandwidth Product | GBW | $C_L = 100pF$ | | 0.35 | | | * | MHz |
| Slew Rate | SR | | | 0.2 | | | * | $V/\mu s$ |
| Settling Time: 0.1% | | $G = 1, 1V$ Step, $C_L = 100pF$ | | 6 | | | * | μs |
| 0.01% | | $G = 1, 1V$ Step, $C_L = 100pF$ | | 16 | | | * | μs |
| Overload Recovery Time | | (V_{IN}) (Gain) = V_S | | 8 | | | * | μs |
| OUTPUT | | | | | | | | |
| Voltage Output: Positive | | $R_L = 10k\Omega$ to $V_S/2$ | $(V+) - 1$ | $(V+) - 0.6$ | | * | * | V |
| Negative | | $R_L = 10k\Omega$ to $V_S/2$ | 0.25 | 0.05 | | * | * | V |
| Positive | | $R_L = 10k\Omega$ to Ground | $(V+) - 1$ | $(V+) - 0.65$ | | * | * | V |
| Negative | | $R_L = 10k\Omega$ to Ground | 0.1 | 0.05 | | * | * | V |
| Short-Circuit Current | I_{SC} | | | ± 8 | | * | * | mA |
| Capacitive Load Drive (Stable Operation) ⁽³⁾ | | $G = +1$ | | 1000 | | * | * | pF |
| POWER SUPPLY | | | | | | | | |
| Specified Operating Voltage | | | +2.7 | +2.7 | | * | * | V |
| Operating Voltage Range | | | | | +36 | * | * | V |
| Quiescent Current (per amplifier) | I_Q | $I_O = 0$ | | 250 | 300 | * | * | μA |
| TEMPERATURE RANGE | | | | | | | | |
| Specified Range | | | -40 | | +85 | * | * | $^\circ C$ |
| Operating Range | | | -40 | | +125 | * | * | $^\circ C$ |
| Storage | | | -55 | | +125 | * | * | $^\circ C$ |
| Thermal Resistance | θ_{JA} | | | | | | | |
| 8-Pin DIP | | | | 100 | | * | * | $^\circ C/W$ |
| SO-8 Surface-Mount | | | | 150 | | * | * | $^\circ C/W$ |
| MSOP-8 Surface-Mount | | | | 220 | | * | * | $^\circ C/W$ |
| 14-Pin DIP | | | | 80 | | * | * | $^\circ C/W$ |
| SO-14 Surface-Mount | | | | 110 | | * | * | $^\circ C/W$ |

* Specifications same as OPA234U, E.

NOTES: (1) Wafer-level tested to 95% confidence level. (2) Positive conventional current flows into the input terminals. (3) See *Small-Signal Overshoot vs Load Capacitance* typical curve.

ELECTRICAL CHARACTERISTICS: $V_S = \pm 15V$

At $T_A = 25^\circ C$, $V_S = \pm 15V$, and $R_L = 10k\Omega$ connected to ground, unless otherwise noted.

| PARAMETER | CONDITION | OPA234U, E OPA2234U | | | OPA234UA, EA OPA2234UA OPA4234UA, U | | | UNITS | |
|---|--|--|----------------------|---|---|-------------|------------------------------|-----------------------------------|--|
| | | MIN | TYP | MAX | MIN | TYP | MAX | | |
| OFFSET VOLTAGE Input Offset Voltage OPA4234U Model vs Temperature ⁽¹⁾ vs Power Supply vs Time Channel Separation (Dual, Quad) | V_{OS} dV_{OS}/dT $PSRR$ | $V_{CM} = 0V$ Operating Temperature Range $V_S = \pm 1.35V$ to $\pm 18V$, $V_{CM} = 0V$ | | ± 70 ± 0.5 3 0.2 0.3 | ± 250 ± 5 10 | | * ± 70 * * * | ± 500 ± 250 * 20 | μV μV $\mu V/^\circ C$ $\mu V/V$ $\mu V/mo$ $\mu V/V$ |
| INPUT BIAS CURRENT Input Bias Current ⁽²⁾ Input Offset Current | I_B I_{OS} | $V_{CM} = 0V$ $V_{CM} = 0V$ | | -12 ± 1 | -25 ± 5 | | * * | -50 * | nA nA |
| NOISE Input Voltage Noise Density Current Noise Density | V_n i_n | $f = 1kHz$ | | 25 80 | | | * * | | nV/\sqrt{Hz} fA/\sqrt{Hz} |
| INPUT VOLTAGE RANGE Common-Mode Voltage Range Common-Mode Rejection | CMRR | $V_{CM} = -15V$ to $14V$ | (V-) 91 | 106 | (V+) -1 | * 86 | * * | * * | V dB |
| INPUT IMPEDANCE Differential Common-Mode | | $V_{CM} = 0V$ | | $10^7 \parallel 5$ $10^{10} \parallel 6$ | | | * * | | $\Omega \parallel pF$ $\Omega \parallel pF$ |
| OPEN-LOOP GAIN Open-Loop Voltage Gain | A_{OL} | $V_O = -14.5V$ to $14V$ | 110 | 120 | | 100 | * | | dB |
| FREQUENCY RESPONSE Gain-Bandwidth Product Slew Rate Settling Time: 0.1% 0.01% Overload Recovery Time | GBW SR | $C_L = 100pF$ $G = 1, 10V$ Step, $C_L = 100pF$ $G = 1, 10V$ Step, $C_L = 100pF$ (V_{IN}) (Gain) = V_S | | 0.35 0.2 41 47 22 | | | * * * * * | | MHz V/ μs μs μs μs |
| OUTPUT Voltage Output: Positive Negative Short-Circuit Current Capacitive Load Drive (Stable Operation) ⁽³⁾ | I_{SC} | $G = +1$ | (V+) -1 (V-) +0.5 | (V+) -0.7 (V-) +0.15 ± 22 1000 | | * * | * * * * | | V V mA pF |
| POWER SUPPLY Specified Operating Voltage Operating Voltage Range Quiescent Current (per amplifier) | I_Q | $I_O = 0$ | ± 1.35 | ± 15 ± 275 | ± 18 ± 350 | * * | * * | * * | V V μA |
| TEMPERATURE RANGE Specified Range Operating Range Storage Thermal Resistance 8-Pin DIP SO-8 Surface-Mount MSOP-8 Surface-Mount 14-Pin DIP SO-14 Surface-Mount | θ_{JA} | | -40 -40 -55 | | +85 +125 +125 | * * * | * * * | * * * | $^\circ C$ $^\circ C$ $^\circ C$ $^\circ C/W$ $^\circ C/W$ $^\circ C/W$ $^\circ C/W$ $^\circ C/W$ |

* Specifications same as OPA234U, E.

NOTES: (1) Wafer-level tested to 95% confidence level. (2) Positive conventional current flows into the input terminals. (3) See *Small-Signal Overshoot vs Load Capacitance* typical curve.



ELECTROSTATIC DISCHARGE SENSITIVITY

This integrated circuit can be damaged by ESD. Texas Instruments recommends that all integrated circuits be handled with appropriate precautions. Failure to observe proper handling and installation procedures can cause damage.

ESD damage can range from subtle performance degradation to complete device failure. Precision integrated circuits may be more susceptible to damage because very small parametric changes could cause the device not to meet its published specifications.

PACKAGE INFORMATION

| PRODUCT | PACKAGE | PACKAGE MARKING |
|---|--|---------------------------------|
| Single OPA234EA OPA234E OPA234UA OPA234U | MSOP-8 Surface-Mount " SO-8 Surface-Mount " | A34 " OPA234UA OPA234U |
| Dual OPA2234UA OPA2234U | SO-8 Surface-Mount " | OPA2234UA OPA2234U |
| Quad OPA4234UA OPA4234U | SO-8 Surface-Mount " | OPA4234UA OPA4234U |

NOTE: (1) For the most current package and ordering information, see the Package Option Addendum located at the end of this data sheet.

ABSOLUTE MAXIMUM RATINGS

| | |
|---|--------------------------|
| Supply Voltage, V+ to V- | 36V |
| Input Voltage | (V-) -0.7V to (V+) +0.7V |
| Output Short-Circuit ⁽¹⁾ | Continuous |
| Operating Temperature | -40°C to +125°C |
| Storage Temperature | -55°C to +125°C |
| Junction Temperature | 150°C |
| Lead Temperature (soldering, 10s) | 300°C |

NOTE: (1) Short-circuit to ground, one amplifier per package.

TYPICAL CHARACTERISTIC CURVES

At $T_A = +25^\circ\text{C}$ and $R_L = 10\text{k}\Omega$, unless otherwise noted.

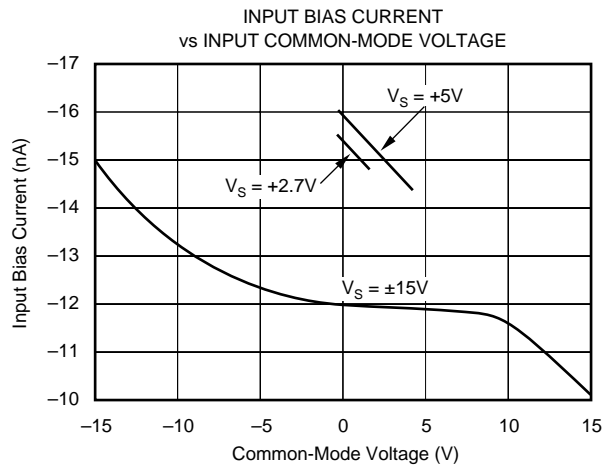
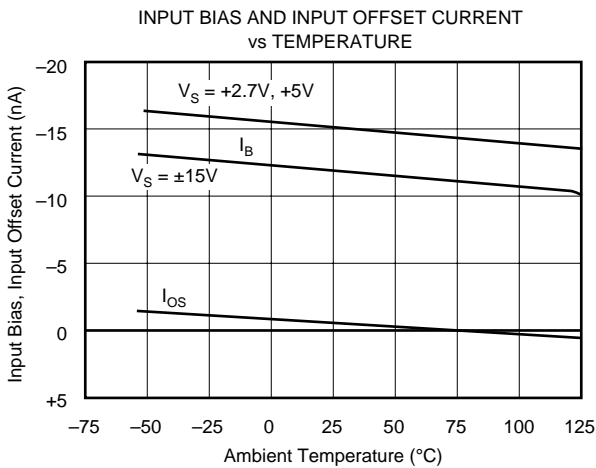
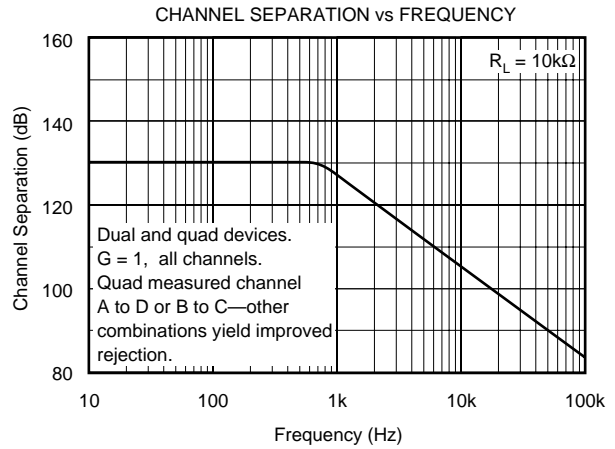
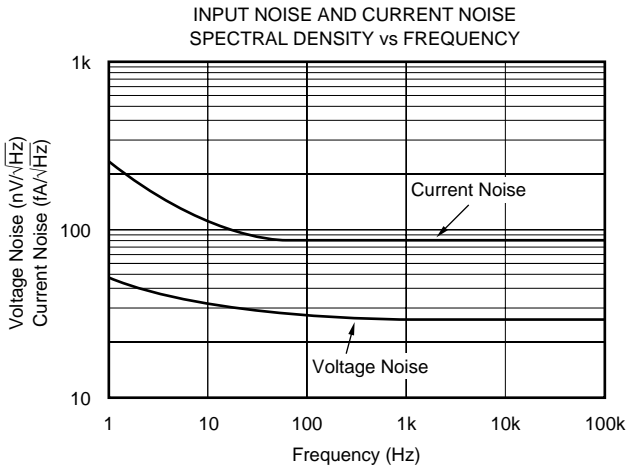
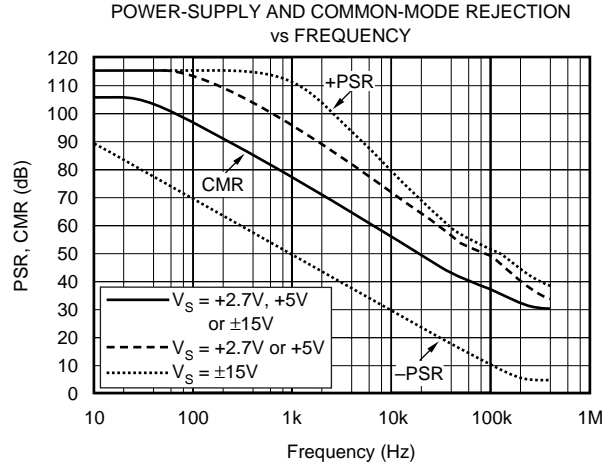
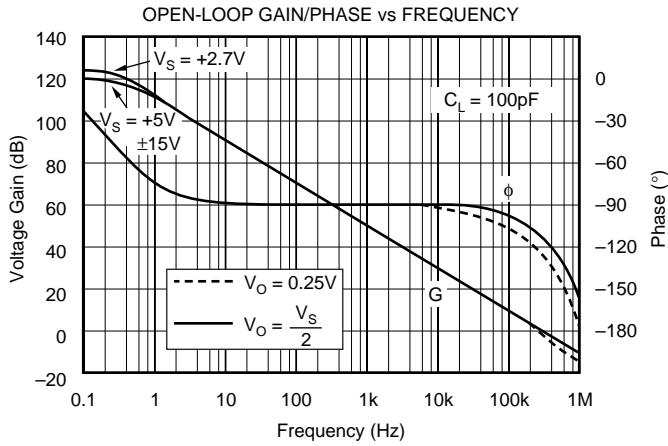

TYPICAL CHARACTERISTIC CURVES (Cont.)

At $T_A = +25^\circ\text{C}$ and $R_L = 10\text{k}\Omega$, unless otherwise noted.

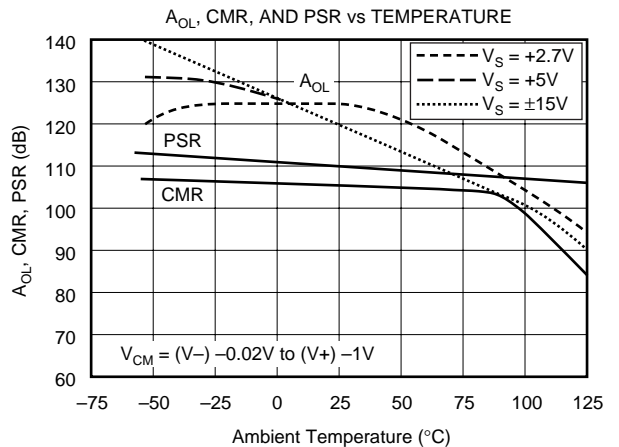
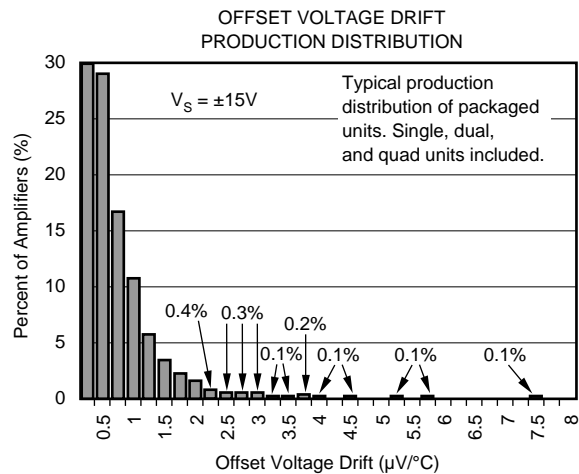
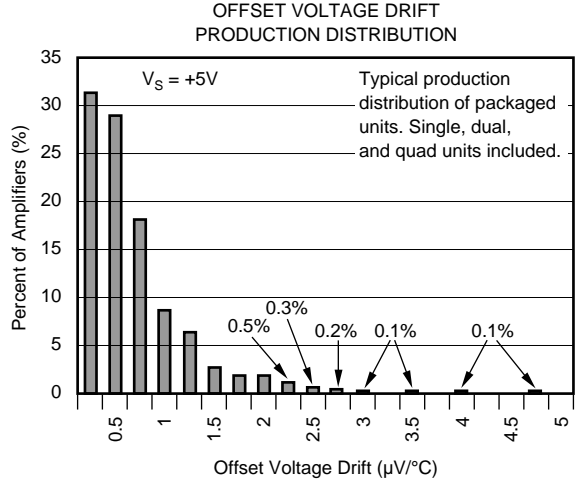
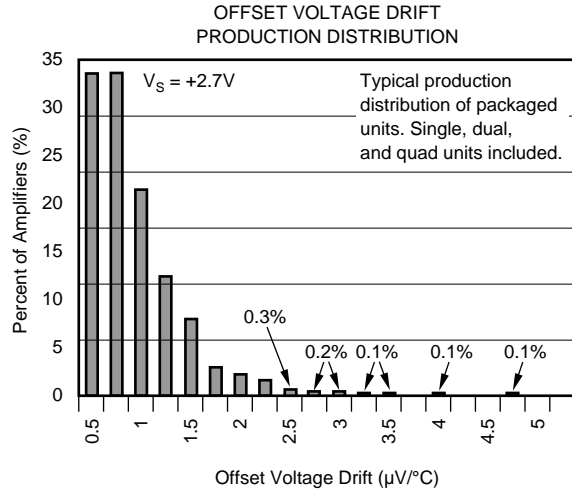
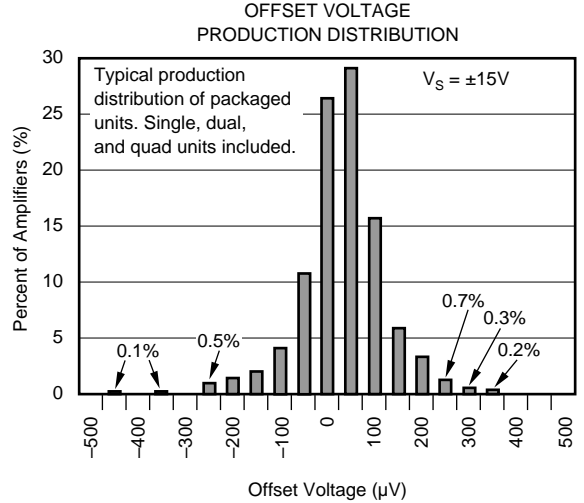
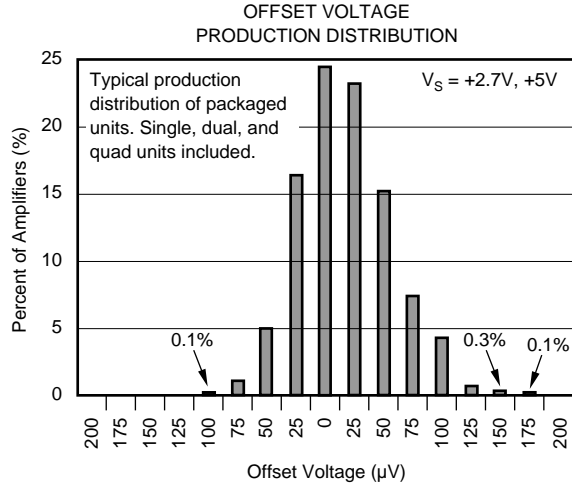

TYPICAL CHARACTERISTIC CURVES (Cont.)

At $T_A = +25^\circ\text{C}$ and $R_L = 10\text{k}\Omega$, unless otherwise noted.

SMALL-SIGNAL STEP RESPONSE
 $G = 1, C_L = 100\text{pF}, V_S = +5\text{V}$

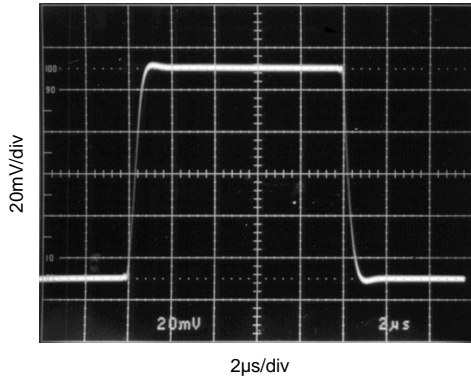

SMALL-SIGNAL STEP RESPONSE
 $G = 1, C_L = 10,000\text{pF}, V_S = +5\text{V}$

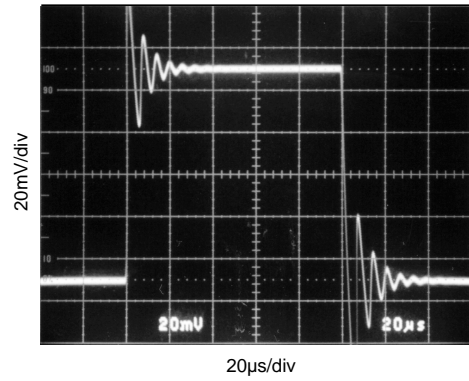

LARGE-SIGNAL STEP RESPONSE
 $G = 1, C_L = 100\text{pF}, V_S = +5\text{V}$

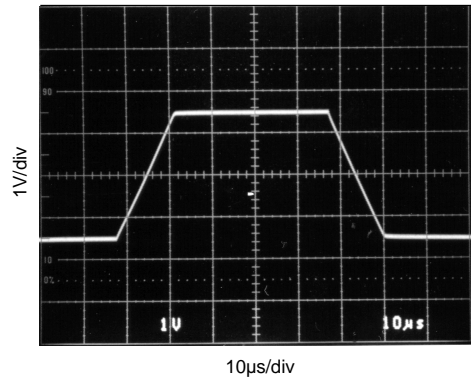

SETTLING TIME vs CLOSED-LOOP GAIN

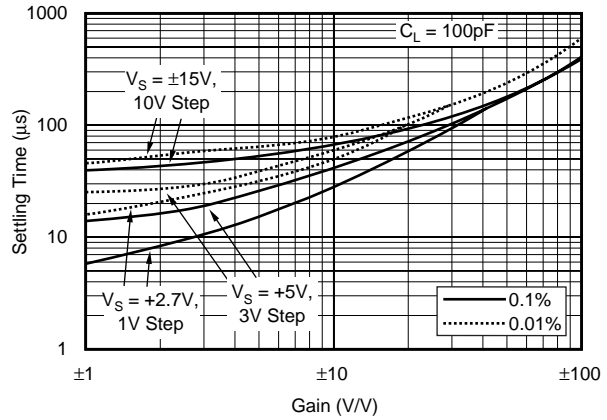

OUTPUT VOLTAGE SWING vs OUTPUT CURRENT

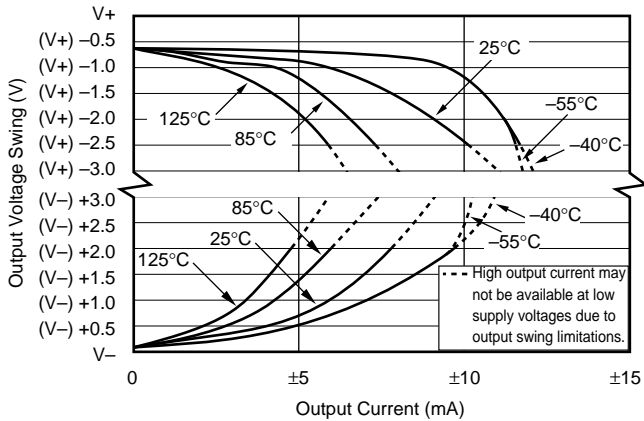

SMALL-SIGNAL OVERSHOOT vs LOAD CAPACITANCE

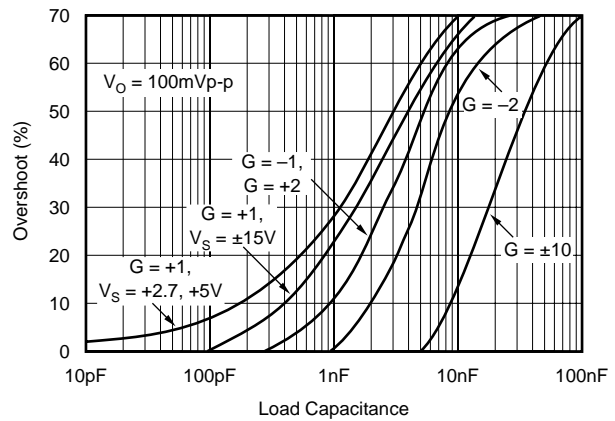

TYPICAL CHARACTERISTIC CURVES (Cont.)

At $T_A = +25^\circ\text{C}$ and $R_L = 10\text{k}\Omega$, unless otherwise noted.

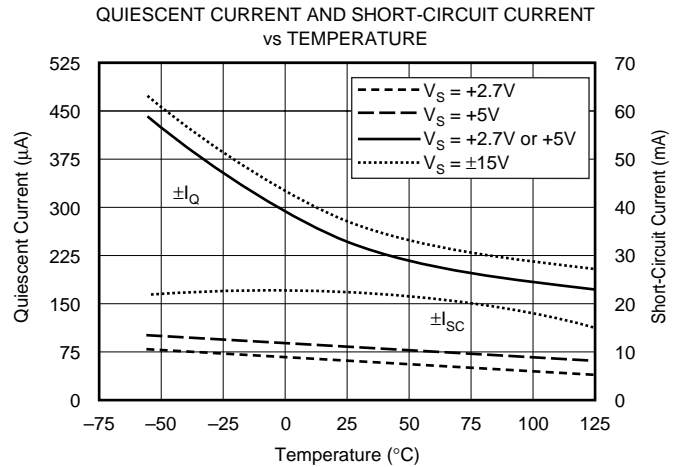
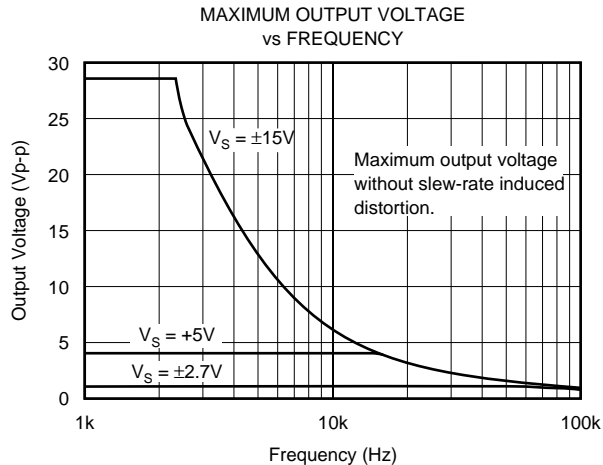

APPLICATIONS INFORMATION

The OPA234 series op amps are unity-gain stable and suitable for a wide range of general-purpose applications. Power-supply pins should be bypassed with 10nF ceramic capacitors.

OPERATING VOLTAGE

The OPA234 series op amps operate from single (+2.7V to +36V) or dual ($\pm 1.35\text{V}$ to $\pm 18\text{V}$) supplies with excellent performance. Specifications are production tested with +2.7V, +5V, and $\pm 15\text{V}$ supplies. Most behavior remains unchanged throughout the full operating voltage range. Parameters which vary significantly with operating voltage are shown in the Typical Characteristic curves.

OFFSET VOLTAGE TRIM

Offset voltage of the OPA234 series amplifiers is laser trimmed and usually requires no user adjustment. The OPA234 (single op amp version) provides offset voltage trim connections on pins 1 and 5. Offset voltage can be adjusted by connecting a potentiometer, as shown in Figure 1. This adjustment should be used only to null the offset of the op amp, not to adjust system offset or offset produced by the signal source. Nulling offset could degrade the offset drift behavior of the op amp. While it is not possible to predict the exact change in drift, the effect is usually small.

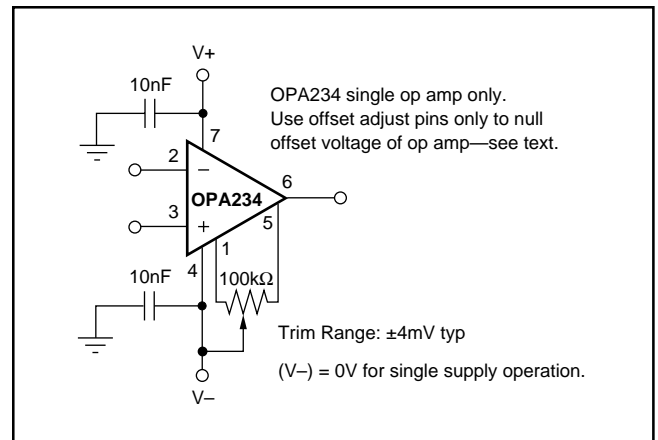

FIGURE 1. OPA234 Offset Voltage Trim Circuit.

PACKAGING INFORMATION

| ORDERABLE DEVICE | STATUS(1) | PACKAGE TYPE | PACKAGE DRAWING | PINS | PACKAGE QTY |
|------------------|-----------|--------------|-----------------|------|-------------|
| OPA2234P | OBSOLETE | PDIP | P | 8 | |
| OPA2234PA | OBSOLETE | PDIP | P | 8 | |
| OPA2234U | ACTIVE | SOIC | D | 8 | 100 |
| OPA2234U/2K5 | ACTIVE | SOIC | D | 8 | 2500 |
| OPA2234UA | ACTIVE | SOIC | D | 8 | 100 |
| OPA2234UA/2K5 | ACTIVE | SOIC | D | 8 | 2500 |
| OPA234E/250 | ACTIVE | VSSOP | DGK | 8 | 250 |
| OPA234E/2K5 | ACTIVE | VSSOP | DGK | 8 | 2500 |
| OPA234EA/250 | ACTIVE | VSSOP | DGK | 8 | 250 |
| OPA234EA/2K5 | ACTIVE | VSSOP | DGK | 8 | 2500 |
| OPA234P | OBSOLETE | PDIP | P | 8 | |
| OPA234PA | OBSOLETE | PDIP | P | 8 | |
| OPA234U | ACTIVE | SOIC | D | 8 | 100 |
| OPA234U/2K5 | ACTIVE | SOIC | D | 8 | 2500 |
| OPA234UA | ACTIVE | SOIC | D | 8 | 100 |
| OPA234UA/2K5 | ACTIVE | SOIC | D | 8 | 2500 |
| OPA4234PA | OBSOLETE | PDIP | N | 14 | |
| OPA4234U | ACTIVE | SOIC | D | 14 | 58 |
| OPA4234U/2K5 | ACTIVE | SOIC | D | 14 | 2500 |
| OPA4234UA | ACTIVE | SOIC | D | 14 | 58 |
| OPA4234UA/2K5 | ACTIVE | SOIC | D | 14 | 2500 |

(1) The marketing status values are defined as follows:

ACTIVE: Product device recommended for new designs.

LIFEBUY: TI has announced that the device will be discontinued, and a lifetime-buy period is in effect.

NRND: Not recommended for new designs. Device is in production to support existing customers, but TI does not recommend using this part in a new design.

PREVIEW: Device has been announced but is not in production. Samples may or may not be available.

OBSOLETE: TI has discontinued the production of the device.

P (R-PDIP-T8)

PLASTIC DUAL-IN-LINE

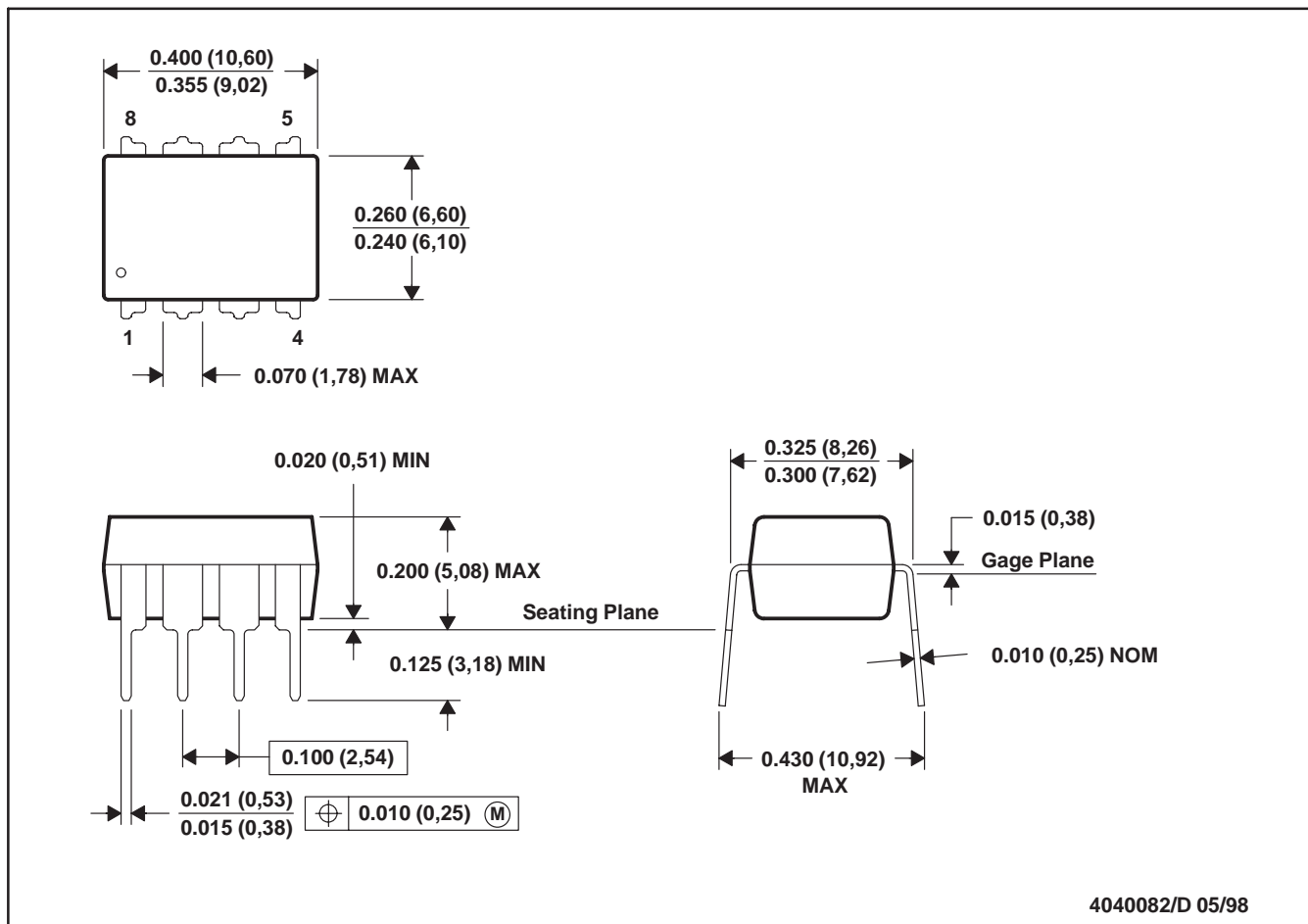

- NOTES: A. All linear dimensions are in inches (millimeters).
 B. This drawing is subject to change without notice.
 C. Falls within JEDEC MS-001

For the latest package information, go to http://www.ti.com/sc/docs/package/pkg_info.htm

N (R-PDIP-T**)

PLASTIC DUAL-IN-LINE PACKAGE

16 PINS SHOWN



- NOTES:
- A. All linear dimensions are in inches (millimeters).
 - B. This drawing is subject to change without notice.
 - C Falls within JEDEC MS-001, except 18 and 20 pin minimum body length (Dim A).
 - D The 20 pin end lead shoulder width is a vendor option, either half or full width.

4040049/E 12/2002

DGK (S-PDSO-G8)

PLASTIC SMALL-OUTLINE PACKAGE

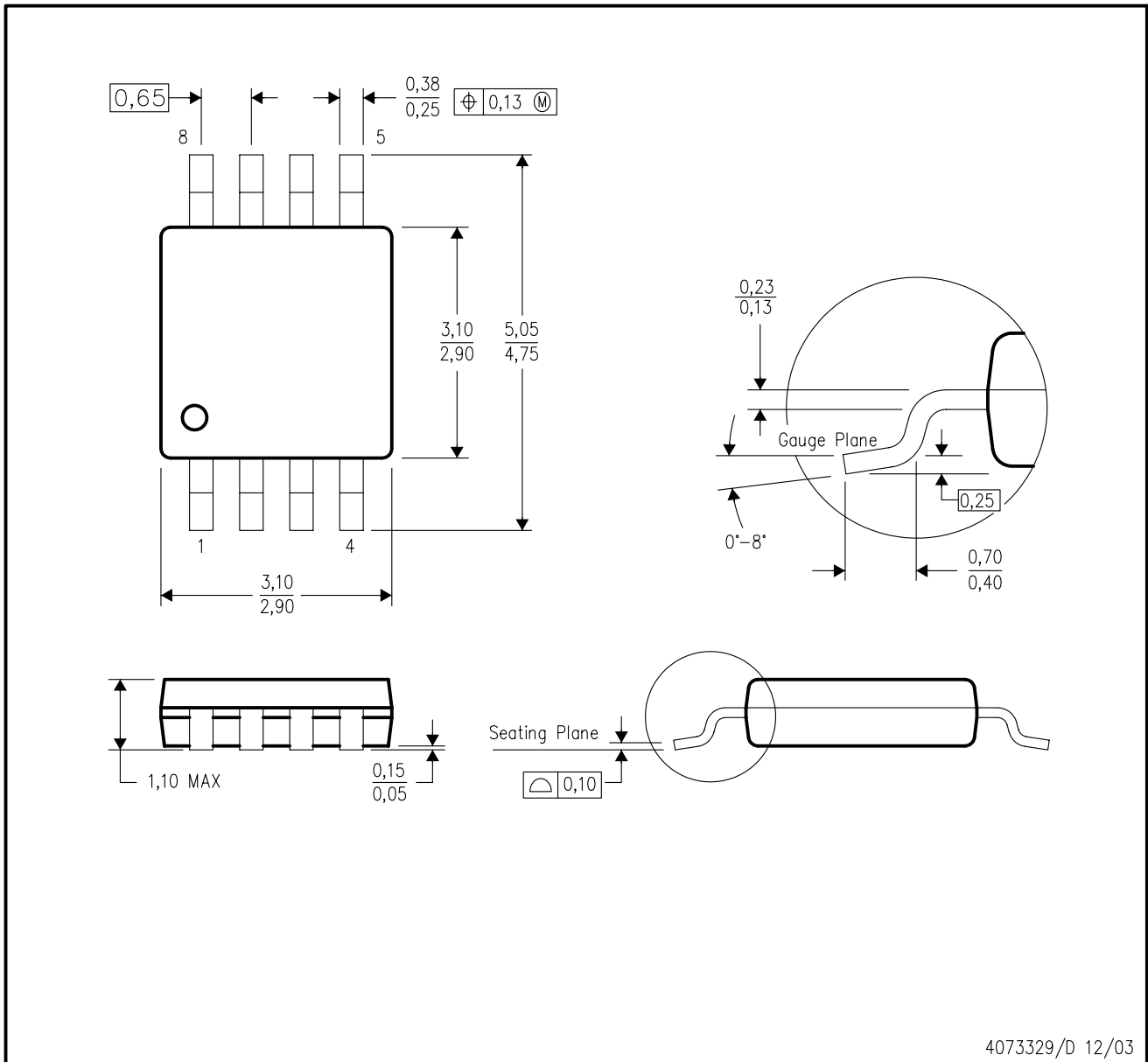

- NOTES:
- A. All linear dimensions are in millimeters.
 - B. This drawing is subject to change without notice.
 - C. Body dimensions do not include mold flash or protrusion.
 - D. Falls within JEDEC MO-187 variation AA.

D (R-PDSO-G**)

PLASTIC SMALL-OUTLINE PACKAGE

8 PINS SHOWN

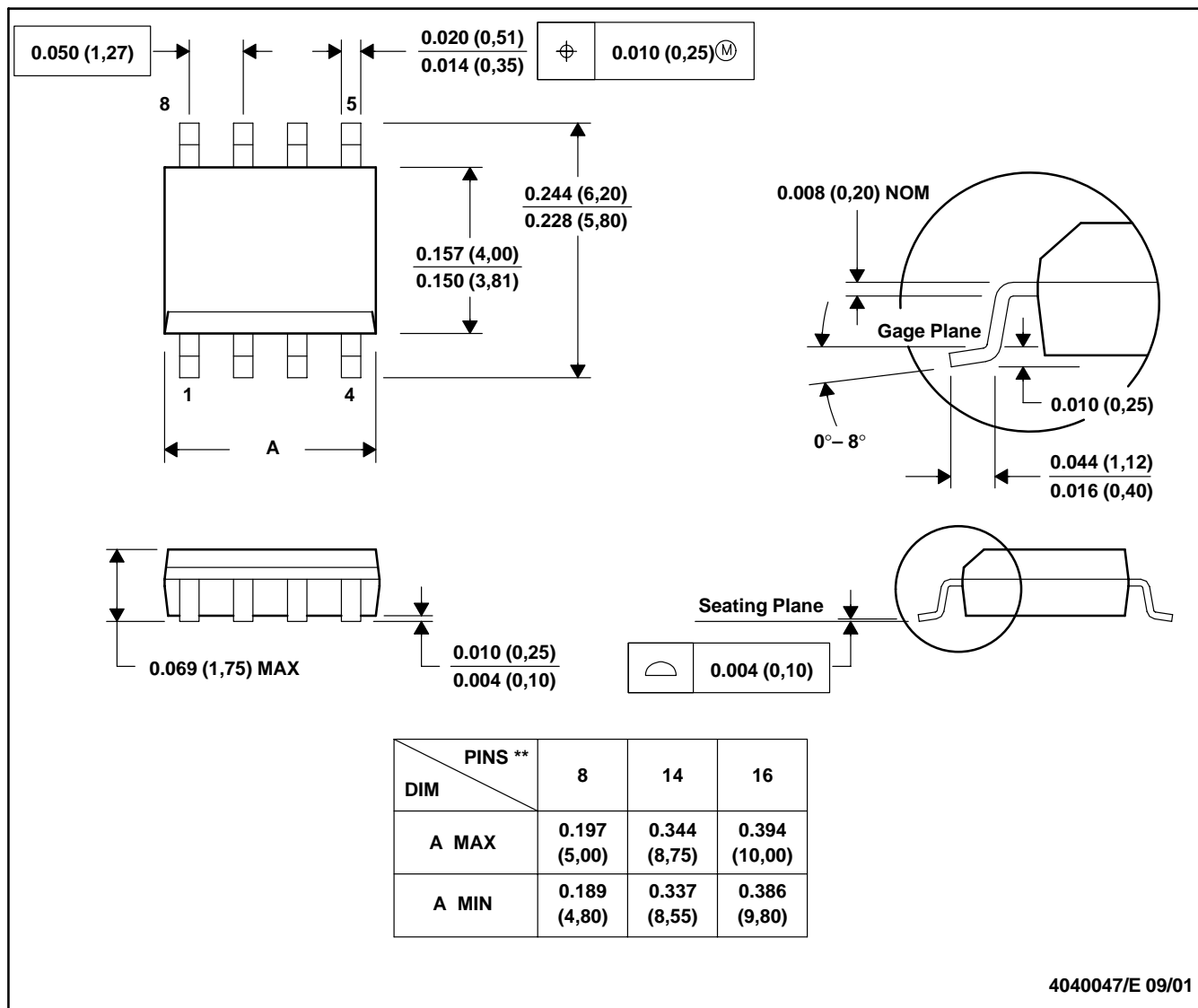

4040047/E 09/01

- NOTES: A. All linear dimensions are in inches (millimeters).
 B. This drawing is subject to change without notice.
 C. Body dimensions do not include mold flash or protrusion, not to exceed 0.006 (0,15).
 D. Falls within JEDEC MS-012

IMPORTANT NOTICE

Texas Instruments Incorporated and its subsidiaries (TI) reserve the right to make corrections, modifications, enhancements, improvements, and other changes to its products and services at any time and to discontinue any product or service without notice. Customers should obtain the latest relevant information before placing orders and should verify that such information is current and complete. All products are sold subject to TI's terms and conditions of sale supplied at the time of order acknowledgment.

TI warrants performance of its hardware products to the specifications applicable at the time of sale in accordance with TI's standard warranty. Testing and other quality control techniques are used to the extent TI deems necessary to support this warranty. Except where mandated by government requirements, testing of all parameters of each product is not necessarily performed.

TI assumes no liability for applications assistance or customer product design. Customers are responsible for their products and applications using TI components. To minimize the risks associated with customer products and applications, customers should provide adequate design and operating safeguards.

TI does not warrant or represent that any license, either express or implied, is granted under any TI patent right, copyright, mask work right, or other TI intellectual property right relating to any combination, machine, or process in which TI products or services are used. Information published by TI regarding third-party products or services does not constitute a license from TI to use such products or services or a warranty or endorsement thereof. Use of such information may require a license from a third party under the patents or other intellectual property of the third party, or a license from TI under the patents or other intellectual property of TI.

Reproduction of information in TI data books or data sheets is permissible only if reproduction is without alteration and is accompanied by all associated warranties, conditions, limitations, and notices. Reproduction of this information with alteration is an unfair and deceptive business practice. TI is not responsible or liable for such altered documentation.

Resale of TI products or services with statements different from or beyond the parameters stated by TI for that product or service voids all express and any implied warranties for the associated TI product or service and is an unfair and deceptive business practice. TI is not responsible or liable for any such statements.

Following are URLs where you can obtain information on other Texas Instruments products and application solutions:

| Products | | Applications | |
|------------------|--|---------------------|--|
| Amplifiers | amplifier.ti.com | Audio | www.ti.com/audio |
| Data Converters | dataconverter.ti.com | Automotive | www.ti.com/automotive |
| DSP | dsp.ti.com | Broadband | www.ti.com/broadband |
| Interface | interface.ti.com | Digital Control | www.ti.com/digitalcontrol |
| Logic | logic.ti.com | Military | www.ti.com/military |
| Power Mgmt | power.ti.com | Optical Networking | www.ti.com/opticalnetwork |
| Microcontrollers | microcontroller.ti.com | Security | www.ti.com/security |
| | | Telephony | www.ti.com/telephony |
| | | Video & Imaging | www.ti.com/video |
| | | Wireless | www.ti.com/wireless |

Mailing Address: Texas Instruments
Post Office Box 655303 Dallas, Texas 75265