

1-MHz, Micro-Power, Low-Noise, RRIO, 1.8-V CMOS OPERATIONAL AMPLIFIER Precision Value Line Series

Check for Samples: [OPA313](#), [OPA2313](#), [OPA4313](#)

FEATURES

- **Low I_Q :** 50 $\mu\text{A}/\text{ch}$
- **Wide Supply Range:** 1.8 V to 5.5 V
- **Low Noise:** 25 $\text{nV}/\sqrt{\text{Hz}}$ at 1 kHz
- **Gain Bandwidth:** 1 MHz
- **Low Input Bias Current:** 0.2 pA
- **Low Offset Voltage:** 0.5 mV
- **Unity-Gain Stable**
- **Internal RF/EMI Filter**
- **Extended Temperature Range:** -40°C to $+125^\circ\text{C}$

APPLICATIONS

- **Battery-Powered Instruments:**
 - Consumer, Industrial, Medical
 - Notebooks, Portable Media Players
- **Sensor Signal Conditioning:**
 - Loop-Powered
 - Notebooks, Portable Media Players
- **Wireless Sensors:**
 - Home Security
 - Remote Sensing
 - Wireless Metering

DESCRIPTION

The OPA313 family of single-, dual-, and quad-channel op amps represents a new generation of low-cost, general purpose, micro-power operational amplifiers. Featuring rail-to-rail input and output swings, and low quiescent current (50 μA , typ) combined with a wide bandwidth of 1 MHz and very low noise (25 $\text{nV}/\sqrt{\text{Hz}}$ at 1 kHz) makes this family very attractive for a variety of battery-powered applications that require a good balance between cost and performance. The low input bias current supports those op amps to be used in applications with megaohm source impedances.

The robust design of the OPA313 devices provides ease-of-use to the circuit designer: unity-gain stability with capacitive loads of up to 150 pF, integrated RF/EMI rejection filter, no phase reversal in overdrive conditions, and high electrostatic discharge (ESD) protection (4-kV HBM).

These devices are optimized for operation at voltages as low as +1.8 V (± 0.9 V) and up to +5.5 V (± 2.75 V), and are specified over the extended temperature range of -40°C to $+125^\circ\text{C}$.

The OPA313 (single) is available in both SC70-5 and SOT23-5 packages. The OPA2313 (dual) is offered in SO-8, MSOP-8, and DFN-8 packages. The quad-channel OPA4313 is offered in a TSSOP-14 package.



Please be aware that an important notice concerning availability, standard warranty, and use in critical applications of Texas Instruments semiconductor products and disclaimers thereto appears at the end of this data sheet.

All trademarks are the property of their respective owners.



This integrated circuit can be damaged by ESD. Texas Instruments recommends that all integrated circuits be handled with appropriate precautions. Failure to observe proper handling and installation procedures can cause damage.

ESD damage can range from subtle performance degradation to complete device failure. Precision integrated circuits may be more susceptible to damage because very small parametric changes could cause the device not to meet its published specifications.

PACKAGE INFORMATION⁽¹⁾

| PRODUCT | PACKAGE-LEAD | PACKAGE DESIGNATOR | SPECIFIED TEMPERATURE RANGE | PACKAGE MARKING |
|---------|--------------|--------------------|-----------------------------|-----------------|
| OPA313 | SC70-5 | DCK | –40°C to +125°C | SIE |
| | SOT23-5 | DBV | –40°C to +125°C | SIF |
| OPA2313 | SO-8 | D | –40°C to +125°C | OP2313 |
| | MSOP-8 | DGK | –40°C to +125°C | OUSS |
| | DFN-8 | DRG | –40°C to +125°C | SDY |
| OPA4313 | TSSOP-14 | PW | –40°C to +125°C | OPA4313 |

(1) For the most current package and ordering information, see the Package Option Addendum at the end of this document, or visit the device product folder at www.ti.com.

ABSOLUTE MAXIMUM RATINGS⁽¹⁾

Over operating free-air temperature range, unless otherwise noted.

| | | OPA313, OPA2313, OPA4313 | UNIT |
|---------------------------------------|----------------------------|--------------------------|------|
| Supply voltage | | 7 | V |
| Signal input terminals | Voltage ⁽²⁾ | (V–) – 0.5 to (V+) + 0.5 | V |
| | Current ⁽²⁾ | ±10 | mA |
| Output short-circuit ⁽³⁾ | | Continuous | mA |
| Operating temperature, T _A | | –40 to +150 | °C |
| Storage temperature, T _{stg} | | –65 to +150 | °C |
| Junction temperature, T _J | | +150 | °C |
| ESD rating | Human body model (HBM) | 4000 | V |
| | Charged device model (CDM) | 1000 | V |
| | Machine model (MM) | 200 | V |

- (1) Stresses above these ratings may cause permanent damage. Exposure to absolute maximum conditions for extended periods may degrade device reliability. These are stress ratings only, and functional operation of the device at these or any other conditions beyond those specified is not supported.
- (2) Input terminals are diode-clamped to the power-supply rails. Input signals that can swing more than 0.5 V beyond the supply rails should be current limited to 10 mA or less.
- (3) Short-circuit to ground, one amplifier per package.

ELECTRICAL CHARACTERISTICS: +5.5 V⁽¹⁾

 At $T_A = +25^\circ\text{C}$, $R_L = 10\text{ k}\Omega$ connected to $V_S / 2$, and $V_{CM} = V_{OUT} = V_S / 2$, unless otherwise noted.

| PARAMETER | | TEST CONDITIONS | OPA313, OPA2313, OPA4313 | | | UNIT |
|----------------------------|------------------------------------|---|--------------------------|-----------|---------------|------------------------------|
| | | | MIN | TYP | MAX | |
| OFFSET VOLTAGE | | | | | | |
| V_{OS} | Input offset voltage | | | 0.5 | 2.5 | mV |
| dV_{OS}/dT | vs Temperature | $T_A = -40^\circ\text{C}$ to $+125^\circ\text{C}$ | | 2 | | $\mu\text{V}/^\circ\text{C}$ |
| PSRR | vs power supply | $T_A = -40^\circ\text{C}$ to $+125^\circ\text{C}$ | 74 | 90 | | dB |
| | Channel separation, dc | At dc | | 10 | | $\mu\text{V}/\text{V}$ |
| INPUT VOLTAGE RANGE | | | | | | |
| V_{CM} | Common-mode voltage range | No phase reversal, rail-to-rail input | $(V_-) - 0.2$ | | $(V_+) + 0.2$ | V |
| CMRR | Common-mode rejection ratio | $T_A = -40^\circ\text{C}$ to $+125^\circ\text{C}$, $(V_{S-}) - 0.2\text{ V} < V_{CM} < (V_{S+}) - 1.3\text{ V}$ | 70 | 85 | | dB |
| | | $T_A = -40^\circ\text{C}$ to $+125^\circ\text{C}$, $V_{CM} = -0.2\text{ V}$ to 5.7 V | 64 | 80 | | dB |
| INPUT BIAS CURRENT | | | | | | |
| I_B | Input bias current | | | ± 0.2 | ± 10 | pA |
| | | $T_A = -40^\circ\text{C}$ to $+85^\circ\text{C}^{(2)}$ | | | ± 50 | pA |
| | | $T_A = -40^\circ\text{C}$ to $+125^\circ\text{C}^{(2)}$ | | | ± 600 | pA |
| I_{OS} | Input offset current | | | ± 0.2 | ± 10 | pA |
| | | $T_A = -40^\circ\text{C}$ to $+85^\circ\text{C}^{(2)}$ | | | ± 50 | pA |
| | | $T_A = -40^\circ\text{C}$ to $+125^\circ\text{C}^{(2)}$ | | | ± 600 | pA |
| NOISE | | | | | | |
| | Input voltage noise (peak-to-peak) | $f = 0.1\text{ Hz}$ to 10 Hz | | 6 | | μV_{PP} |
| e_n | Input voltage noise density | $f = 10\text{ kHz}$ | | 22 | | $\text{nV}/\sqrt{\text{Hz}}$ |
| | | $f = 1\text{ kHz}$ | | 25 | | $\text{nV}/\sqrt{\text{Hz}}$ |
| i_n | Input current noise density | $f = 1\text{ kHz}$ | | 5 | | $\text{fA}/\sqrt{\text{Hz}}$ |
| INPUT CAPACITANCE | | | | | | |
| C_{IN} | Differential | | | 1 | | pF |
| | Common-mode | | | 5 | | pF |
| OPEN-LOOP GAIN | | | | | | |
| A_{OL} | Open-loop voltage gain | $0.05\text{ V} < V_O < (V_+) - 0.05\text{ V}$, $R_L = 100\text{ k}\Omega$ | 90 | 104 | | dB |
| | | $T_A = -40^\circ\text{C}$ to $+125^\circ\text{C}$, $0.1\text{ V} < V_O < (V_+) - 0.1\text{ V}$ | 104 | 116 | | dB |
| | | $0.3\text{ V} < V_O < (V_+) - 0.3\text{ V}$, $R_L = 2\text{ k}\Omega$ | 100 | 110 | | dB |
| | Phase margin | $V_S = 5.0\text{ V}$, $G = +1$ | | 65 | | degrees |

- (1) Parameters with minimum or maximum specification limits are 100% production tested at $+25^\circ\text{C}$, unless otherwise noted. Over temperature limits are based on characterization and statistical analysis.
- (2) Specified by design and characterization; not production tested.

ELECTRICAL CHARACTERISTICS: +5.5 V⁽¹⁾ (continued)

At $T_A = +25\text{ }^\circ\text{C}$, $R_L = 10\text{ k}\Omega$ connected to $V_S / 2$, and $V_{CM} = V_{OUT} = V_S / 2$, unless otherwise noted.

| PARAMETER | | TEST CONDITIONS | OPA313, OPA2313, OPA4313 | | | UNIT |
|---------------------------|--|--|--------------------------|--------------------|----------|------------------|
| | | | MIN | TYP | MAX | |
| FREQUENCY RESPONSE | | | | | | |
| GBW | Gain-bandwidth product | $V_S = 5.0\text{ V}$, $C_L = 10\text{ pF}$ | | 1 | | MHz |
| SR | Slew rate | $V_S = 5.0\text{ V}$, $G = +1$ | | 0.5 | | V/ μs |
| t_S | Settling time | To 0.1%, $V_S = 5.0\text{ V}$, 2-V step, $G = +1$ | | 5 | | μs |
| | | To 0.01%, $V_S = 5.0\text{ V}$, 2-V step, $G = +1$ | | 6 | | μs |
| | Overload recovery time | $V_S = 5.0\text{ V}$, $V_{IN} \times \text{Gain} > V_S$ | | 3 | | μs |
| THD+N | Total harmonic distortion + noise ⁽³⁾ | $V_S = 5.0\text{ V}$, $V_O = 1\text{ V}_{RMS}$, $G = +1$, $f = 1\text{ kHz}$ | | 0.0045% | | |
| OUTPUT | | | | | | |
| V_O | Voltage output swing from supply rails | $R_L = 100\text{ k}\Omega$ ⁽⁴⁾ | | 5 | 20 | mV |
| | | $T_A = -40\text{ }^\circ\text{C}$ to $+125\text{ }^\circ\text{C}$, $R_L = 100\text{ k}\Omega$ ⁽⁴⁾ | | | 30 | mV |
| | | $R_L = 2\text{ k}\Omega$ ⁽⁴⁾ | | 75 | 100 | mV |
| | | $T_A = -40\text{ }^\circ\text{C}$ to $+125\text{ }^\circ\text{C}$, $R_L = 2\text{ k}\Omega$ | | | 125 | mV |
| I_{SC} | Short-circuit current | | | ± 15 | | mA |
| | | $T_A = -40\text{ }^\circ\text{C}$ to $+125\text{ }^\circ\text{C}$ | | | ± 12 | mA |
| R_O | Open-loop output impedance | | | 2300 | | Ω |
| POWER SUPPLY | | | | | | |
| V_S | Specified voltage range | | 1.8 (± 0.9) | 5.5 (± 2.75) | | V |
| I_Q | Quiescent current per amplifier | $I_O = 0\text{ mA}$, $V_S = 5.0\text{ V}$ | | 50 | 60 | μA |
| | | $T_A = -40\text{ }^\circ\text{C}$ to $+125\text{ }^\circ\text{C}$, $V_S = 5.0\text{ V}$, $I_O = 0\text{ mA}$ | | | 85 | μA |
| | Power-on time | $V_S = 0\text{ V}$ to 5 V , to 90% I_Q level | | 10 | | μs |
| TEMPERATURE | | | | | | |
| | Specified range | | -40 | +125 | | $^\circ\text{C}$ |
| | Operating range | | -40 | +150 | | $^\circ\text{C}$ |
| | Storage range | | -65 | +150 | | $^\circ\text{C}$ |

(3) Third-order filter; bandwidth = 80 kHz at -3 dB.

(4) Specified by design and characterization; not production tested.

ELECTRICAL CHARACTERISTICS: +1.8 V⁽¹⁾

 At $T_A = +25^\circ\text{C}$, $R_L = 10\text{ k}\Omega$ connected to $V_S / 2$, $V_{CM} = V_{S+} - 1.3\text{ V}$, and $V_{OUT} = V_S / 2$, unless otherwise noted.

| PARAMETER | | TEST CONDITIONS | OPA313, OPA2313, OPA4313 | | | UNIT |
|----------------------------|------------------------------------|---|--------------------------|-----------|---------------|------------------------------|
| | | | MIN | TYP | MAX | |
| OFFSET VOLTAGE | | | | | | |
| V_{OS} | Input offset voltage | | | 0.5 | 2.5 | mV |
| dV_{OS}/dT | vs Temperature | $T_A = -40^\circ\text{C}$ to $+125^\circ\text{C}$ | | 2 | | $\mu\text{V}/^\circ\text{C}$ |
| PSRR | vs power supply | $T_A = -40^\circ\text{C}$ to $+125^\circ\text{C}$ | 74 | 90 | | dB |
| | Channel separation, dc | At dc | | 10 | | $\mu\text{V}/\text{V}$ |
| INPUT VOLTAGE RANGE | | | | | | |
| V_{CM} | Common-mode voltage range | No phase reversal, rail-to-rail input | $(V_-) - 0.2$ | | $(V_+) + 0.2$ | V |
| CMRR | Common-mode rejection ratio | $T_A = -40^\circ\text{C}$ to $+125^\circ\text{C}$, $(V_{S-}) - 0.2\text{ V} < V_{CM} < (V_{S+}) - 1.3\text{ V}$ | 70 | 85 | | dB |
| | | $V_S = 1.8\text{ V}$, $V_{CM} = -0.2\text{ V}$ to $+1.8\text{ V}$ | 58 | 73 | | |
| | | $T_A = -40^\circ\text{C}$ to $+125^\circ\text{C}$, $V_{CM} = -0.2\text{ V}$ to 1.6 V | 58 | 70 | | dB |
| INPUT BIAS CURRENT | | | | | | |
| I_B | Input bias current | | | ± 0.2 | ± 10 | μA |
| | | $T_A = -40^\circ\text{C}$ to $+85^\circ\text{C}$ ⁽²⁾ | | | ± 50 | μA |
| | | $T_A = -40^\circ\text{C}$ to $+125^\circ\text{C}$ ⁽²⁾ | | | ± 600 | μA |
| I_{OS} | Input offset current | | | ± 0.2 | ± 10 | μA |
| | | $T_A = -40^\circ\text{C}$ to $+85^\circ\text{C}$ ⁽²⁾ | | | ± 50 | μA |
| | | $T_A = -40^\circ\text{C}$ to $+125^\circ\text{C}$ ⁽²⁾ | | | ± 600 | μA |
| NOISE | | | | | | |
| | Input voltage noise (peak-to-peak) | $f = 0.1\text{ Hz}$ to 10 Hz | | 6 | | μV_{PP} |
| e_n | Input voltage noise density | $f = 10\text{ kHz}$ | | 22 | | $\text{nV}/\sqrt{\text{Hz}}$ |
| | | $f = 1\text{ kHz}$ | | 25 | | $\text{nV}/\sqrt{\text{Hz}}$ |
| i_n | Input current noise density | $f = 1\text{ kHz}$ | | 5 | | $\text{fA}/\sqrt{\text{Hz}}$ |
| INPUT CAPACITANCE | | | | | | |
| C_{IN} | Differential | | | 1 | | pF |
| | Common-mode | | | 5 | | pF |
| OPEN-LOOP GAIN | | | | | | |
| A_{OL} | Open-loop voltage gain | $T_A = -40^\circ\text{C}$ to $+125^\circ\text{C}$, $0.1\text{ V} < V_O < (V_+) - 0.1\text{ V}$ | 90 | 110 | | dB |
| | | $0.05\text{ V} < V_O < (V_+) - 0.05\text{ V}$, $R_L = 100\text{ k}\Omega$ | 100 | 110 | | dB |

- (1) Parameters with minimum or maximum specification limits are 100% production tested at $+25^\circ\text{C}$, unless otherwise noted. Over temperature limits are based on characterization and statistical analysis.
- (2) Specified by design and characterization; not production tested.

ELECTRICAL CHARACTERISTICS: +1.8 V⁽¹⁾ (continued)

At $T_A = +25\text{ }^\circ\text{C}$, $R_L = 10\text{ k}\Omega$ connected to $V_S / 2$, $V_{CM} = V_{S+} - 1.3\text{ V}$, and $V_{OUT} = V_S / 2$, unless otherwise noted.

| PARAMETER | | TEST CONDITIONS | OPA313, OPA2313, OPA4313 | | | UNIT |
|---------------------------|--|---|--------------------------|--------------------|-----|------------------|
| | | | MIN | TYP | MAX | |
| FREQUENCY RESPONSE | | | | | | |
| GBW | Gain-bandwidth product | $C_L = 10\text{ pF}$ | 0.9 | | | MHz |
| SR | Slew rate | $G = +1$ | 0.45 | | | V/ μs |
| t_S | Settling time | To 0.1%, $V_S = 5.0\text{ V}$, 2-V step, $G = +1$ | 5 | | | μs |
| | | To 0.01%, $V_S = 5.0\text{ V}$, 2-V step, $G = +1$ | 6 | | | μs |
| | Overload recovery time | $V_S = 5.0\text{ V}$, $V_{IN} \times \text{Gain} > V_S$ | 3 | | | μs |
| THD+N | Total harmonic distortion + noise ⁽³⁾ | $V_S = 5.0\text{ V}$, $V_O = 1\text{ V}_{RMS}$, $G = +1$, $f = 1\text{ kHz}$ | 0.0045% | | | |
| OUTPUT | | | | | | |
| V_O | Voltage output swing from supply rails | $R_L = 100\text{ k}\Omega$ ⁽⁴⁾ | 5 | 15 | | mV |
| | | $T_A = -40\text{ }^\circ\text{C}$ to $+125\text{ }^\circ\text{C}$, $R_L = 100\text{ k}\Omega$ ⁽⁴⁾ | | | 30 | mV |
| | | $R_L = 2\text{ k}\Omega$ ⁽⁴⁾ | 25 | 50 | | mV |
| | | $T_A = -40\text{ }^\circ\text{C}$ to $+125\text{ }^\circ\text{C}$, $R_L = 2\text{ k}\Omega$ | | | 125 | mV |
| I_{SC} | Short-circuit current | | ± 6 | | | mA |
| R_O | Open-loop output impedance | | 2300 | | | Ω |
| POWER SUPPLY | | | | | | |
| V_S | Specified voltage range | | 1.8 (± 0.9) | 5.5 (± 2.75) | | V |
| I_Q | Quiescent current per amplifier | $I_O = 0\text{ mA}$ | 50 | 60 | | μA |
| | Power-on time | $V_S = 0\text{ V}$ to 5 V , to 90% I_Q level | 10 | | | μs |
| TEMPERATURE | | | | | | |
| | Specified range | | -40 | +125 | | $^\circ\text{C}$ |
| | Operating range | | -40 | +150 | | $^\circ\text{C}$ |
| | Storage range | | -65 | +150 | | $^\circ\text{C}$ |

(3) Third-order filter; bandwidth = 80 kHz at -3 dB.

(4) Specified by design and characterization; not production tested.

THERMAL INFORMATION: OPA313

| THERMAL METRIC ⁽¹⁾ | | OPA313 | | UNITS |
|-------------------------------|--|-------------|------------|-------|
| | | DBV (SOT23) | DCK (SC70) | |
| | | 5 PINS | 5 PINS | |
| θ_{JA} | Junction-to-ambient thermal resistance | 228.5 | 281.4 | °C/W |
| $\theta_{JC(top)}$ | Junction-to-case(top) thermal resistance | 99.1 | 91.6 | |
| θ_{JB} | Junction-to-board thermal resistance | 54.6 | 59.6 | |
| Ψ_{JT} | Junction-to-top characterization parameter | 7.7 | 1.5 | |
| Ψ_{JB} | Junction-to-board characterization parameter | 53.8 | 58.8 | |
| $\theta_{JC(bottom)}$ | Junction-to-case(bottom) thermal resistance | N/A | N/A | |

(1) For more information about traditional and new thermal metrics, see the *IC Package Thermal Metrics* application report, [SPRA953](#).

THERMAL INFORMATION: OPA2313

| THERMAL METRIC ⁽¹⁾ | | OPA2313 | | | UNITS |
|-------------------------------|--|---------|------------|-----------|-------|
| | | D (SO) | DGK (MSOP) | DRG (DFN) | |
| | | 8 PINS | 8 PINS | 8 PINS | |
| θ_{JA} | Junction-to-ambient thermal resistance | 138.4 | 191.2 | 53.8 | °C/W |
| $\theta_{JC(top)}$ | Junction-to-case(top) thermal resistance | 89.5 | 61.9 | 69.2 | |
| θ_{JB} | Junction-to-board thermal resistance | 78.6 | 111.9 | 20.1 | |
| Ψ_{JT} | Junction-to-top characterization parameter | 29.9 | 5.1 | 3.8 | |
| Ψ_{JB} | Junction-to-board characterization parameter | 78.1 | 110.2 | 20.0 | |
| $\theta_{JC(bottom)}$ | Junction-to-case(bottom) thermal resistance | N/A | N/A | 11.6 | |

(1) For more information about traditional and new thermal metrics, see the *IC Package Thermal Metrics* application report, [SPRA953](#).

THERMAL INFORMATION: OPA4313

| THERMAL METRIC ⁽¹⁾ | | OPA4313 | UNITS |
|-------------------------------|--|------------|-------|
| | | PW (TSSOP) | |
| | | 14 PINS | |
| θ_{JA} | Junction-to-ambient thermal resistance | 121.0 | °C/W |
| $\theta_{JC(top)}$ | Junction-to-case(top) thermal resistance | 49.4 | |
| θ_{JB} | Junction-to-board thermal resistance | 62.8 | |
| Ψ_{JT} | Junction-to-top characterization parameter | 5.9 | |
| Ψ_{JB} | Junction-to-board characterization parameter | 62.2 | |
| $\theta_{JC(bottom)}$ | Junction-to-case(bottom) thermal resistance | N/A | |

(1) For more information about traditional and new thermal metrics, see the *IC Package Thermal Metrics* application report, [SPRA953](#).

PIN CONFIGURATIONS

**DCK PACKAGE
 SC70-5
 (TOP VIEW)**

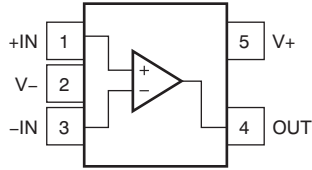

**DBV PACKAGE
 SOT23-5
 (TOP VIEW)**

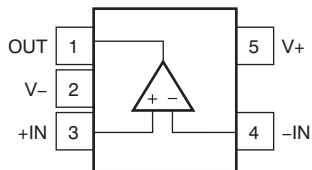

**D, DGK PACKAGES
 SO-8, MSOP-8
 (TOP VIEW)**

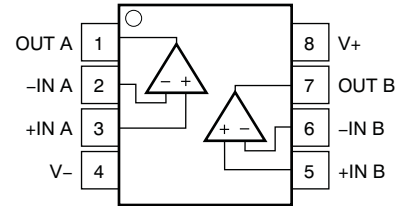

**DRG PACKAGE⁽¹⁾
 DFN-8
 (TOP VIEW)**

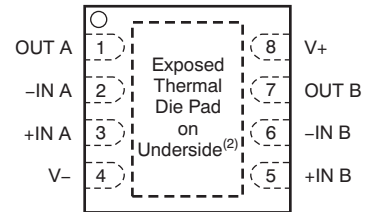

**PW PACKAGE
 TSSOP-14
 (TOP VIEW)**

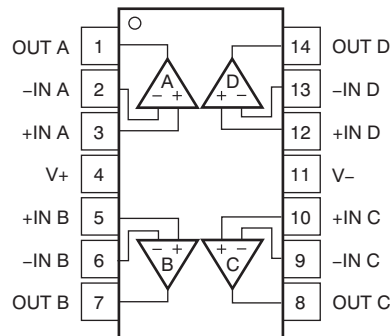

(1) Pitch: 0,65 mm.

(2) Connect thermal pad to V-. Pad size: 1,8 mm x 1,5 mm.

TYPICAL CHARACTERISTICS

Table 1. Characteristic Performance Measurements

| TITLE | FIGURE |
|--|---------------------------|
| Open-Loop Gain and Phase vs Frequency | Figure 1 |
| Open-Loop Gain vs Temperature | Figure 2 |
| Quiescent Current vs Supply Voltage | Figure 3 |
| Quiescent Current vs Temperature | Figure 4 |
| Offset Voltage Production Distribution | Figure 5 |
| Offset Voltage Drift Distribution | Figure 6 |
| Offset Voltage vs Common-Mode Voltage (Maximum Supply) | Figure 7 |
| Offset Voltage vs Temperature | Figure 8 |
| CMRR and PSRR vs Frequency (RTI) | Figure 9 |
| CMRR and PSRR vs Temperature | Figure 10 |
| 0.1-Hz to 10-Hz Input Voltage Noise (5.5 V) | Figure 11 |
| Input Voltage Noise Spectral Density vs Frequency (1.8 V, 5.5 V) | Figure 12 |
| Input Voltage Noise vs Common-Mode Voltage (5.5 V) | Figure 13 |
| Input Bias and Offset Current vs Temperature | Figure 14 |
| Open-Loop Output Impedance vs Frequency | Figure 15 |
| Maximum Output Voltage vs Frequency and Supply Voltage | Figure 16 |
| Output Voltage Swing vs Output Current (over Temperature) | Figure 17 |
| Closed-Loop Gain vs Frequency, $G = 1, -1, 10$ (1.8 V) | Figure 18 |
| Closed-Loop Gain vs Frequency, $G = 1, -1, 10$ (5.5 V) | Figure 19 |
| Small-Signal Overshoot vs Load Capacitance | Figure 20 |
| Phase Margin vs Capacitive Load | Figure 21 |
| Small-Signal Step Response, Noninverting (1.8 V) | Figure 22 |
| Small-Signal Step Response, Noninverting (5.5 V) | Figure 23 |
| Large-Signal Step Response, Noninverting (1.8 V) | Figure 24 |
| Large-Signal Step Response, Noninverting (5.5 V) | Figure 25 |
| Positive Overload Recovery | Figure 26 |
| Negative Overload Recovery | Figure 27 |
| No Phase Reversal | Figure 28 |
| Channel Separation vs Frequency (Dual) | Figure 29 |
| THD+N vs Amplitude ($G = +1, 2\text{ k}\Omega, 10\text{ k}\Omega$) | Figure 30 |
| THD+N vs Amplitude ($G = -1, 2\text{ k}\Omega, 10\text{ k}\Omega$) | Figure 31 |
| THD+N vs Frequency (0.5 V_{RMS} , $G = +1, 2\text{ k}\Omega, 10\text{ k}\Omega$) | Figure 32 |
| EMIRR IN+ vs Frequency | Figure 33 |

TYPICAL CHARACTERISTICS

At $T_A = +25\text{ }^\circ\text{C}$, $V_S = 5\text{ V}$, $R_L = 10\text{ k}\Omega$ connected to $V_S / 2$, and $V_{CM} = V_{OUT} = V_S / 2$, unless otherwise noted.

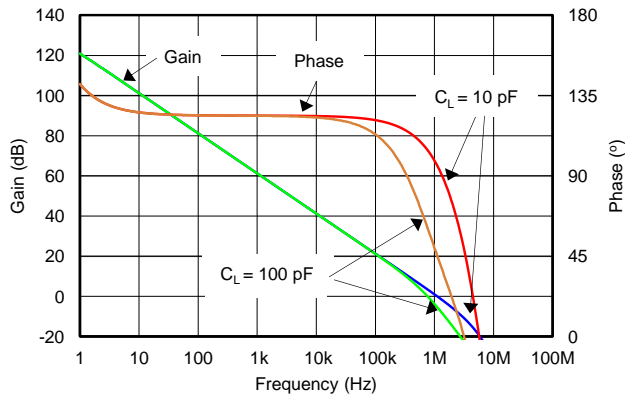

Figure 1. OPEN-LOOP GAIN AND PHASE vs FREQUENCY

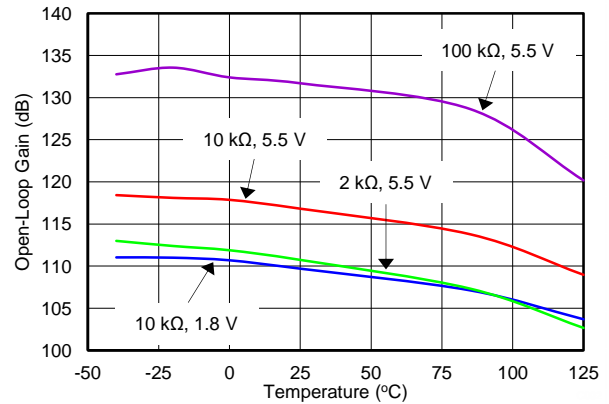

Figure 2. OPEN-LOOP GAIN vs TEMPERATURE

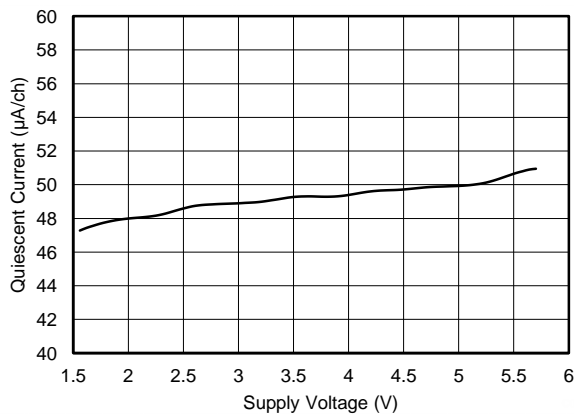

Figure 3. QUIESCENT CURRENT vs SUPPLY

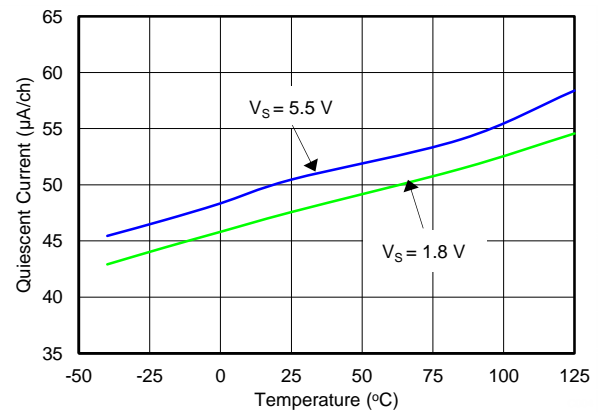

Figure 4. QUIESCENT CURRENT vs TEMPERATURE

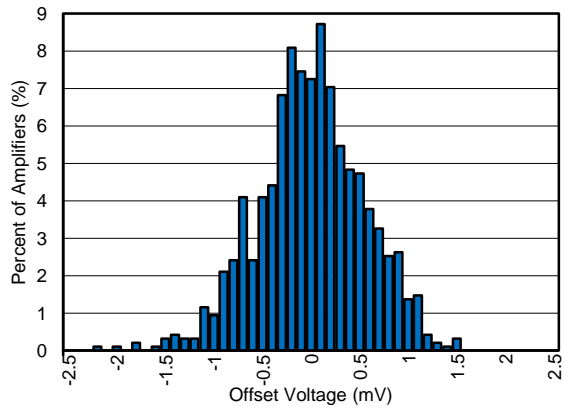

Figure 5. OFFSET VOLTAGE PRODUCTION DISTRIBUTION

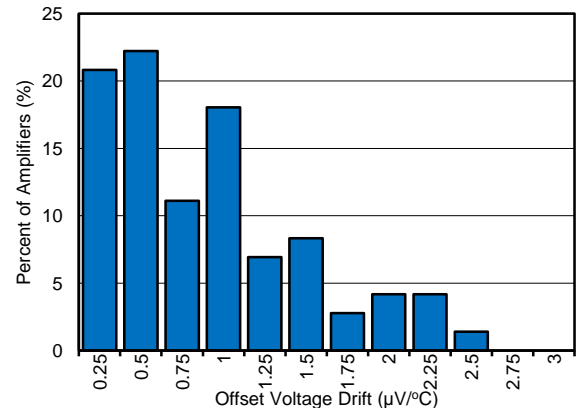

Figure 6. OFFSET VOLTAGE DRIFT DISTRIBUTION

TYPICAL CHARACTERISTICS (continued)

At $T_A = +25\text{ }^\circ\text{C}$, $V_S = 5\text{ V}$, $R_L = 10\text{ k}\Omega$ connected to $V_S / 2$, and $V_{CM} = V_{OUT} = V_S / 2$, unless otherwise noted.

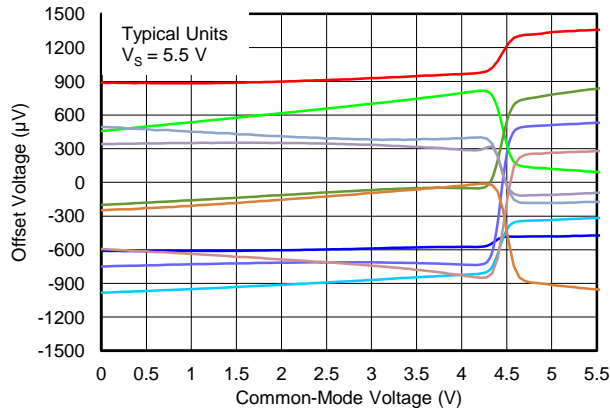

Figure 7. OFFSET VOLTAGE vs COMMON-MODE VOLTAGE

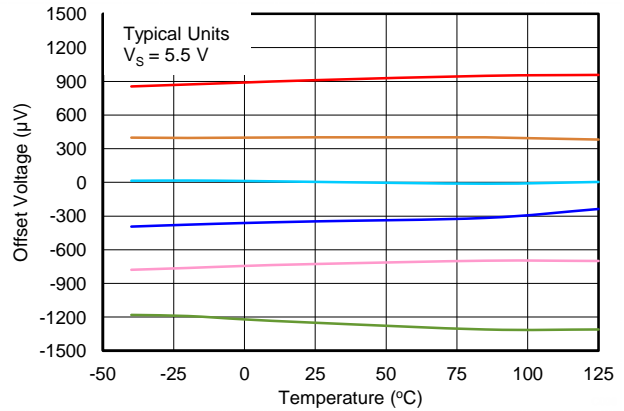

Figure 8. OFFSET VOLTAGE vs TEMPERATURE

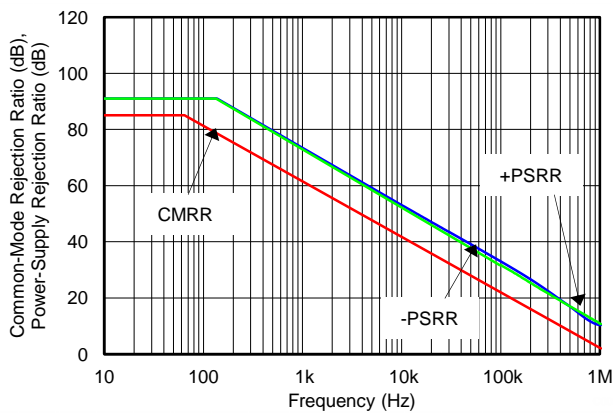

Figure 9. CMRR AND PSRR vs FREQUENCY (Referred-to-Input)

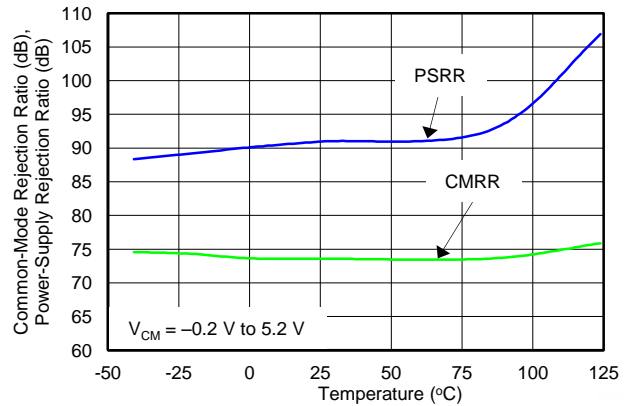

Figure 10. CMRR AND PSRR vs TEMPERATURE

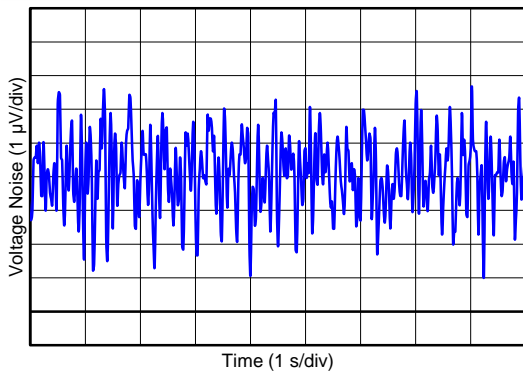

Figure 11. 0.1-Hz TO 10-Hz INPUT VOLTAGE NOISE

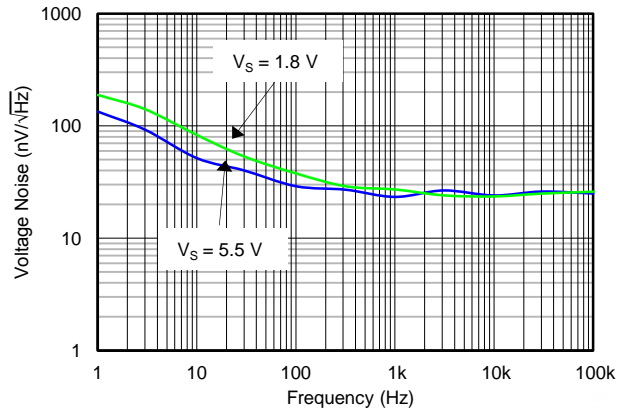

Figure 12. INPUT VOLTAGE NOISE SPECTRAL DENSITY vs FREQUENCY

TYPICAL CHARACTERISTICS (continued)

At $T_A = +25\text{ }^\circ\text{C}$, $V_S = 5\text{ V}$, $R_L = 10\text{ k}\Omega$ connected to $V_S / 2$, and $V_{CM} = V_{OUT} = V_S / 2$, unless otherwise noted.

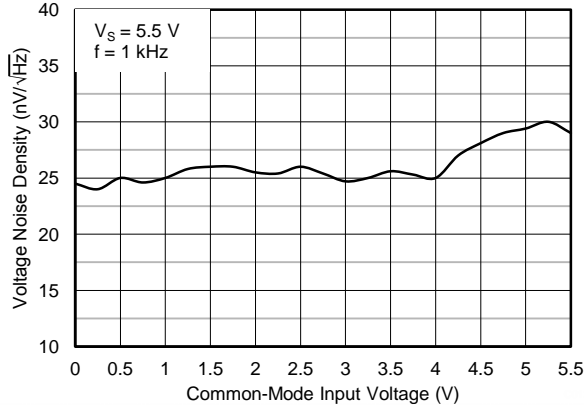

Figure 13. VOLTAGE NOISE vs COMMON-MODE VOLTAGE

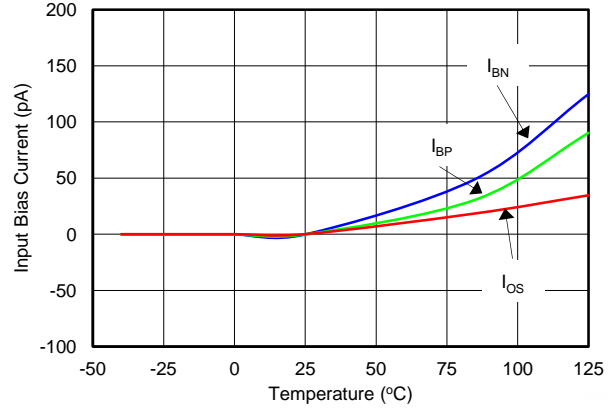

Figure 14. INPUT BIAS AND OFFSET CURRENT vs TEMPERATURE

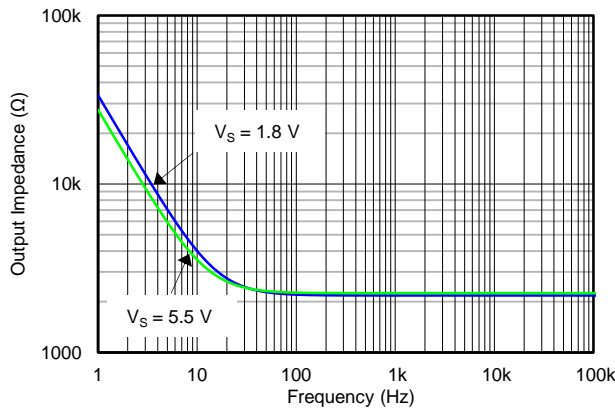

Figure 15. OPEN-LOOP OUTPUT IMPEDANCE vs FREQUENCY

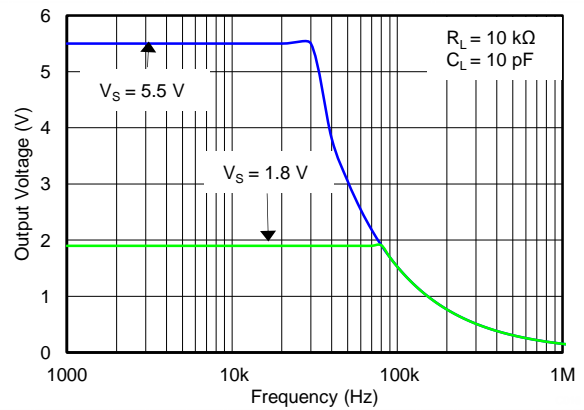

Figure 16. MAXIMUM OUTPUT VOLTAGE vs FREQUENCY AND SUPPLY VOLTAGE

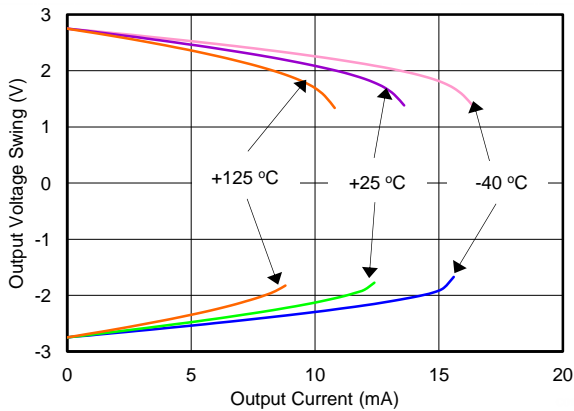

Figure 17. OUTPUT VOLTAGE SWING vs OUTPUT CURRENT (Over Temperature)

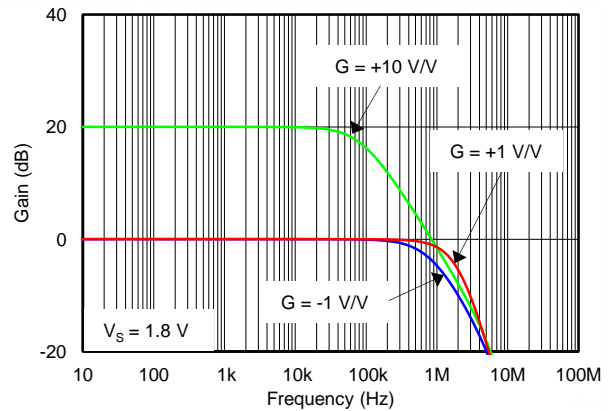

Figure 18. CLOSED-LOOP GAIN vs FREQUENCY (Minimum Supply)

TYPICAL CHARACTERISTICS (continued)

At $T_A = +25\text{ }^\circ\text{C}$, $V_S = 5\text{ V}$, $R_L = 10\text{ k}\Omega$ connected to $V_S / 2$, and $V_{CM} = V_{OUT} = V_S / 2$, unless otherwise noted.

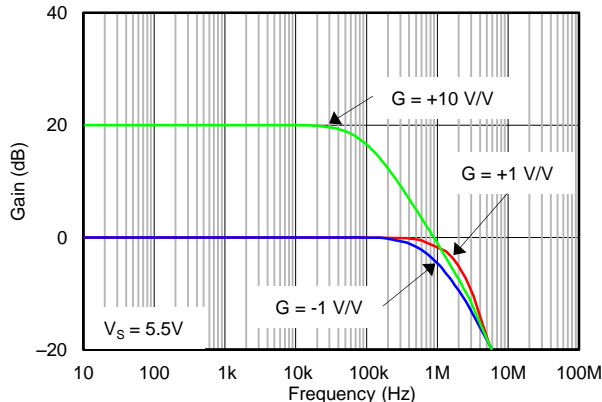

Figure 19. CLOSED-LOOP GAIN vs FREQUENCY (Maximum Supply)

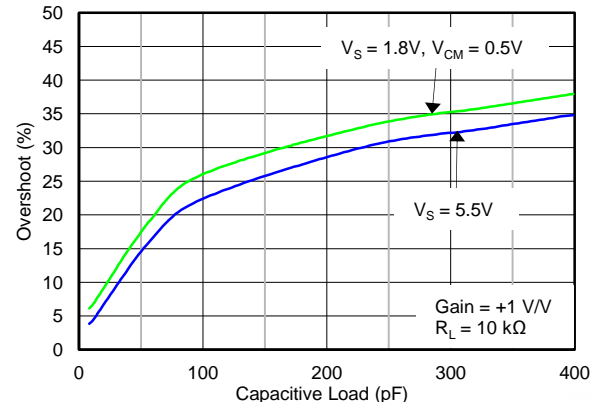

Figure 20. SMALL-SIGNAL OVERSHOOT vs LOAD CAPACITANCE

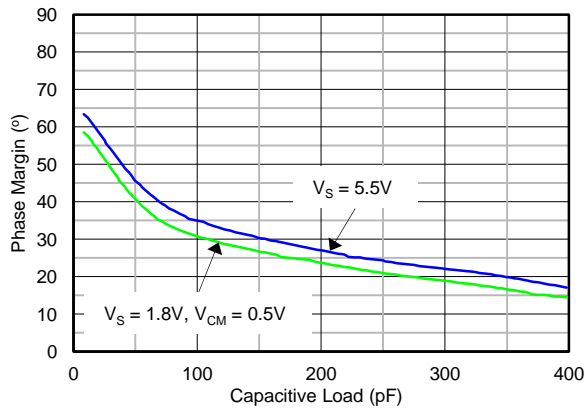

Figure 21. PHASE MARGIN vs CAPACITIVE LOAD

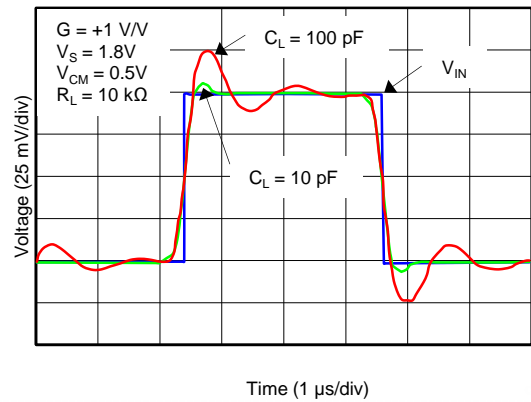

Figure 22. SMALL-SIGNAL PULSE RESPONSE (Minimum Supply)

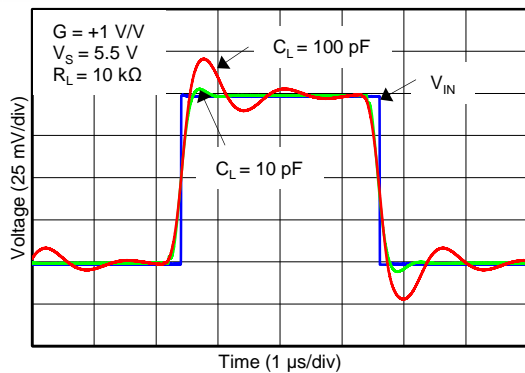

Figure 23. SMALL-SIGNAL PULSE RESPONSE (Maximum Supply)

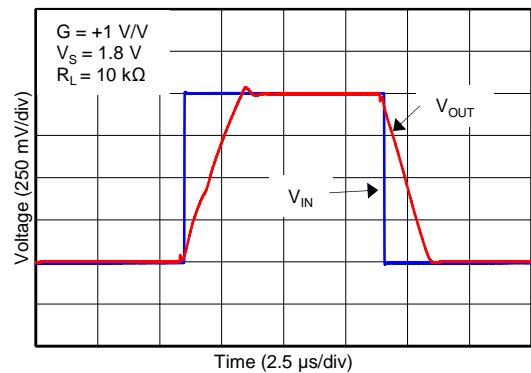

Figure 24. LARGE-SIGNAL PULSE RESPONSE (Minimum Supply)

TYPICAL CHARACTERISTICS (continued)

At $T_A = +25\text{ }^\circ\text{C}$, $V_S = 5\text{ V}$, $R_L = 10\text{ k}\Omega$ connected to $V_S / 2$, and $V_{CM} = V_{OUT} = V_S / 2$, unless otherwise noted.

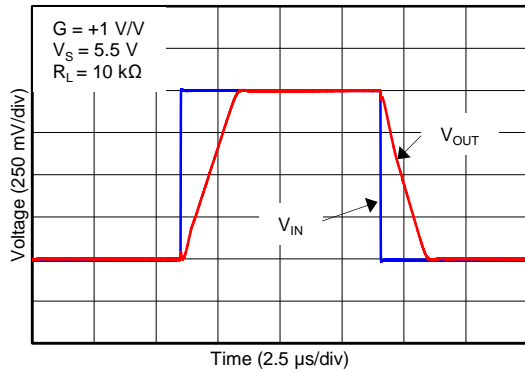

Figure 25. LARGE-SIGNAL PULSE RESPONSE (Maximum Supply)

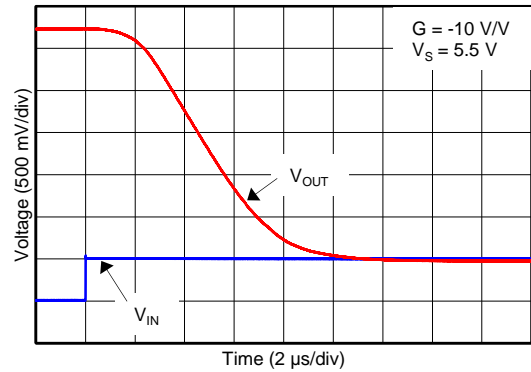

Figure 26. POSITIVE OVERLOAD RECOVERY

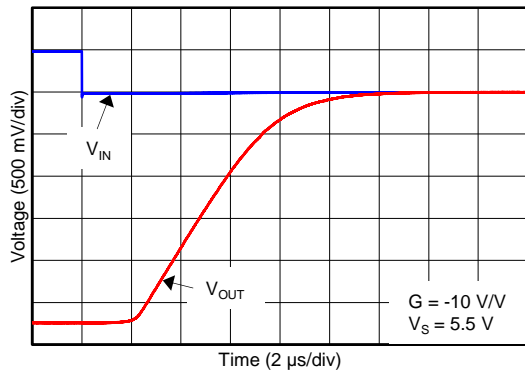

Figure 27. NEGATIVE OVERLOAD RECOVERY

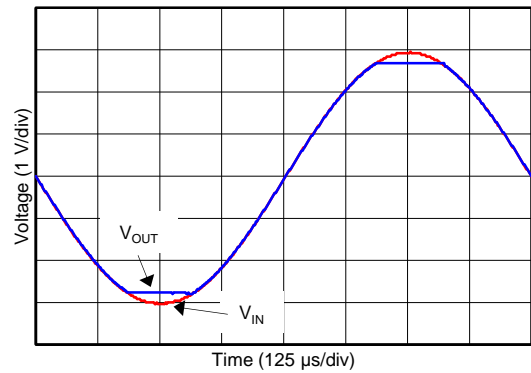

Figure 28. NO PHASE REVERSAL

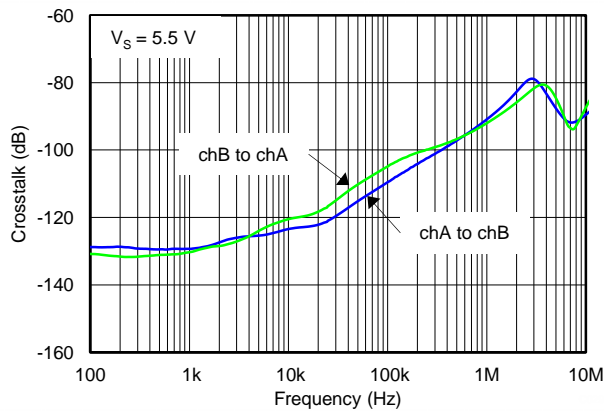

Figure 29. CHANNEL SEPARATION vs FREQUENCY

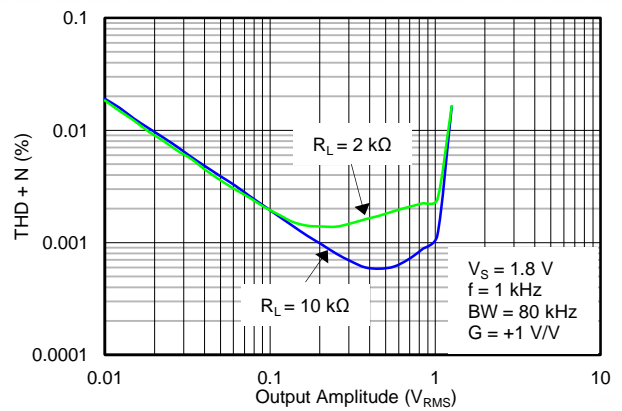

Figure 30. THD+N vs OUTPUT AMPLITUDE (Minimum Supply)

TYPICAL CHARACTERISTICS (continued)

At $T_A = +25\text{ }^\circ\text{C}$, $V_S = 5\text{ V}$, $R_L = 10\text{ k}\Omega$ connected to $V_S / 2$, and $V_{CM} = V_{OUT} = V_S / 2$, unless otherwise noted.

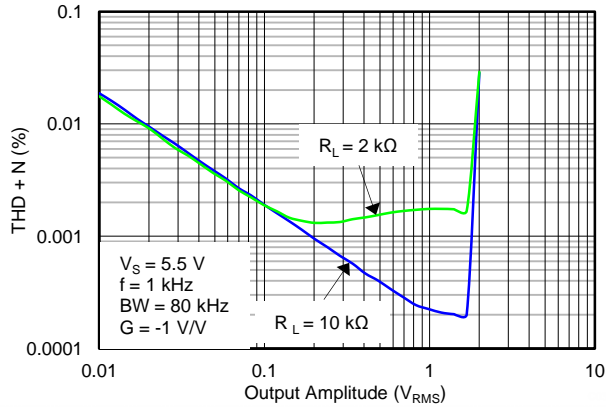

Figure 31. THD+N vs OUTPUT AMPLITUDE (Maximum Supply)

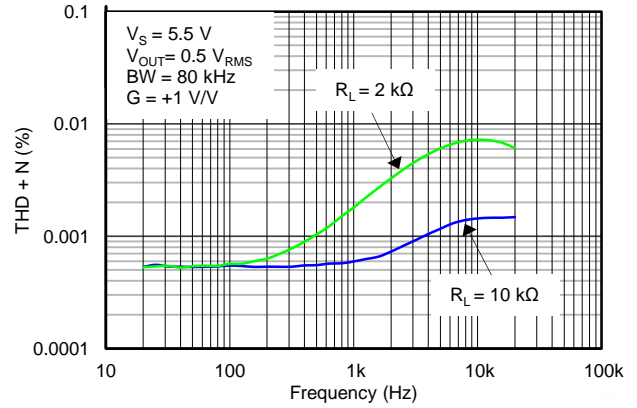

Figure 32. THD+N vs FREQUENCY

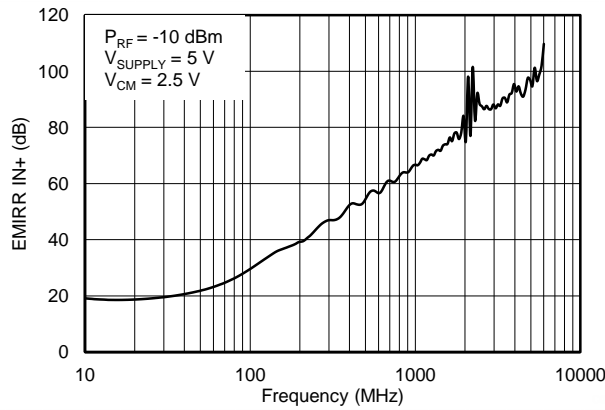

Figure 33. EMIRR IN+ vs FREQUENCY

APPLICATION INFORMATION

The OPA313 is a family of low-power, rail-to-rail input and output operational amplifiers specifically designed for portable applications. These devices operate from 1.8 V to 5.5 V, are unity-gain stable, and suitable for a wide range of general-purpose applications. The class AB output stage is capable of driving $\leq 10\text{-k}\Omega$ loads connected to any point between V_+ and ground. The input common-mode voltage range includes both rails, and allows the OPA313 family to be used in virtually any single-supply application. Rail-to-rail input and output swing significantly increases dynamic range, especially in low-supply applications, and makes them ideal for driving sampling analog-to-digital converters (ADCs).

The OPA313 features 1-MHz bandwidth and $0.5\text{-V}/\mu\text{s}$ slew rate with only $50\text{-}\mu\text{A}$ supply current per channel, providing good ac performance at very low power consumption. DC applications are also well served with a low input noise voltage of $25\text{ nV}/\sqrt{\text{Hz}}$ at 1 kHz, low input bias current (0.2 pA), and an input offset voltage of 0.5 mV (typical). The typical offset voltage drift is $2\text{ }\mu\text{V}/^\circ\text{C}$; over the full temperature range the input offset voltage changes only $200\text{ }\mu\text{V}$ (0.5 mV to 0.7 mV).

OPERATING VOLTAGE

The OPA313 series op amps are fully specified and ensured for operation from $+1.8\text{ V}$ to $+5.5\text{ V}$. In addition, many specifications apply from -40°C to $+125^\circ\text{C}$. Parameters that vary significantly with operating voltages or temperature are shown in the [Typical Characteristics](#) graphs. Power-supply pins should be bypassed with $0.01\text{-}\mu\text{F}$ ceramic capacitors.

RAIL-TO-RAIL INPUT

The input common-mode voltage range of the OPA313 series extends 200 mV beyond the supply rails. This performance is achieved with a complementary input stage: an N-channel input differential pair in parallel with a P-channel differential pair, as shown in [Figure 34](#). The N-channel pair is active for input voltages close to the positive rail, typically $(V_+) - 1.3\text{ V}$ to 200 mV above the positive supply, while the P-channel pair is on for inputs from 200 mV below the negative supply to approximately $(V_+) - 1.3\text{ V}$. There is a small transition region, typically $(V_+) - 1.4\text{ V}$ to $(V_+) - 1.2\text{ V}$, in which both pairs are on. This 200-mV transition region can vary up to 300 mV with process variation. Thus, the transition region (both stages on) can range from $(V_+) - 1.7\text{ V}$ to $(V_+) - 1.5\text{ V}$ on the low end, up to $(V_+) - 1.1\text{ V}$ to $(V_+) - 0.9\text{ V}$ on the high end. Within this transition region, PSRR, CMRR, offset voltage, offset drift, and THD may be degraded compared to device operation outside this region.

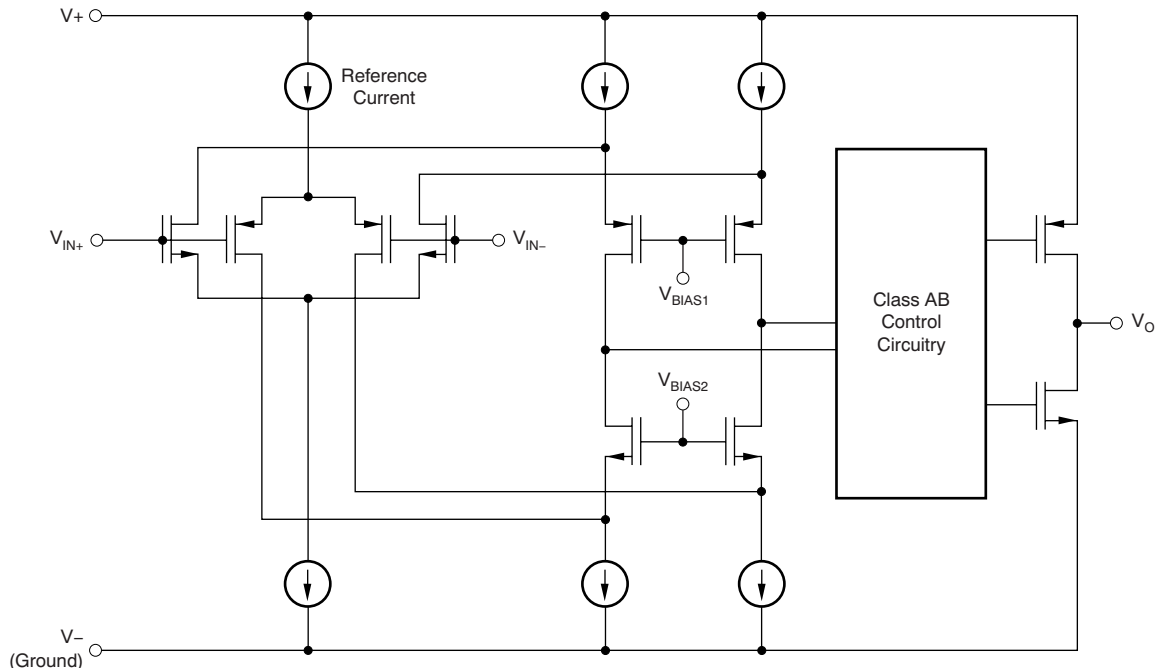

Figure 34. Simplified Schematic

INPUT AND ESD PROTECTION

The OPA313 family incorporates internal electrostatic discharge (ESD) protection circuits on all pins. In the case of input and output pins, this protection primarily consists of current-steering diodes connected between the input and power-supply pins. These ESD protection diodes also provide in-circuit, input overdrive protection, as long as the current is limited to 10 mA as stated in the [Absolute Maximum Ratings](#). [Figure 35](#) shows how a series input resistor may be added to the driven input to limit the input current. The added resistor contributes thermal noise at the amplifier input and its value should be kept to a minimum in noise-sensitive applications.

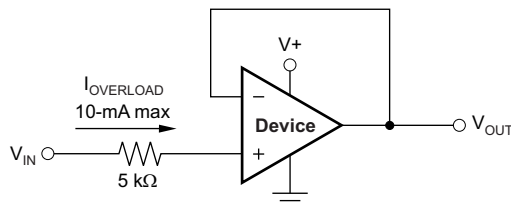

Figure 35. Input Current Protection

COMMON-MODE REJECTION RATIO (CMRR)

CMRR for the OPA313 is specified in several ways so the best match for a given application may be used; see the [Electrical Characteristics](#). First, the CMRR of the device in the common-mode range below the transition region [$V_{CM} < (V+) - 1.3\text{ V}$] is given. This specification is the best indicator of the capability of the device when the application requires use of one of the differential input pairs. Second, the CMRR over the entire common-mode range is specified at ($V_{CM} = -0.2\text{ V}$ to 5.7 V). This last value includes the variations seen through the transition region (see [Figure 7](#)).

EMI SUSCEPTIBILITY AND INPUT FILTERING

Operational amplifiers vary with regard to the susceptibility of the device to electromagnetic interference (EMI). If conducted EMI enters the op amp, the dc offset observed at the amplifier output may shift from its nominal value while EMI is present. This shift is a result of signal rectification associated with the internal semiconductor junctions. While all op amp pin functions can be affected by EMI, the signal input pins are likely to be the most susceptible. The OPA313 operational amplifier family incorporate an internal input low-pass filter that reduces the amplifiers response to EMI. Both common-mode and differential mode filtering are provided by this filter. The filter is designed for a cutoff frequency of approximately 35 MHz (-3 dB), with a roll-off of 20 dB per decade.

Texas Instruments has developed the ability to accurately measure and quantify the immunity of an operational amplifier over a broad frequency spectrum extending from 10 MHz to 6 GHz. The EMI rejection ratio (EMIRR) metric allows op amps to be directly compared by the EMI immunity. [Figure 33](#) illustrates the results of this testing on the OPA313 family. Detailed information can also be found in the application report, *EMI Rejection Ratio of Operational Amplifiers* ([SBOA128](#)), available for download from www.ti.com.

RAIL-TO-RAIL OUTPUT

Designed as a micro-power, low-noise operational amplifier, the OPA313 delivers a robust output drive capability. A class AB output stage with common-source transistors is used to achieve full rail-to-rail output swing capability. For resistive loads up to 10 k Ω , the output swings typically to within 5 mV of either supply rail regardless of the power-supply voltage applied. Different load conditions change the ability of the amplifier to swing close to the rails; refer to the typical characteristic graph, [Output Voltage Swing vs Output Current](#).

CAPACITIVE LOAD AND STABILITY

The OPA313 is designed to be used in applications where driving a capacitive load is required. As with all op amps, there may be specific instances where the OPA313 can become unstable. The particular op amp circuit configuration, layout, gain, and output loading are some of the factors to consider when establishing whether or not an amplifier is stable in operation. An op amp in the unity-gain (+1-V/V) buffer configuration that drives a capacitive load exhibits a greater tendency to be unstable than an amplifier operated at a higher noise gain. The capacitive load, in conjunction with the op amp output resistance, creates a pole within the feedback loop that degrades the phase margin. The degradation of the phase margin increases as the capacitive loading increases. When operating in the unity-gain configuration, the OPA313 remains stable with a pure capacitive load up to approximately 1 nF. The equivalent series resistance (ESR) of some very large capacitors (C_L greater than 1 μ F) is sufficient to alter the phase characteristics in the feedback loop such that the amplifier remains stable. Increasing the amplifier closed-loop gain allows the amplifier to drive increasingly larger capacitance. This increased capability is evident when observing the overshoot response of the amplifier at higher voltage gains. See the typical characteristic graph, [Small-Signal Overshoot vs. Capacitive Load](#).

One technique for increasing the capacitive load drive capability of the amplifier operating in a unity-gain configuration is to insert a small resistor, typically 10 Ω to 20 Ω , in series with the output, as shown in [Figure 36](#). This resistor significantly reduces the overshoot and ringing associated with large capacitive loads. One possible problem with this technique, however, is that a voltage divider is created with the added series resistor and any resistor connected in parallel with the capacitive load. The voltage divider introduces a gain error at the output that reduces the output swing.

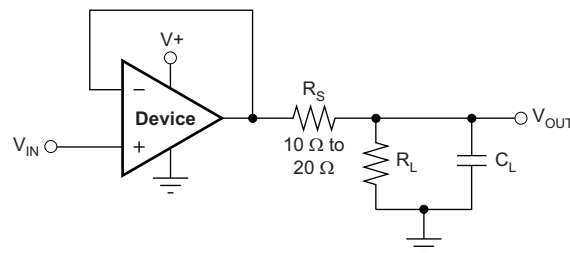

Figure 36. Improving Capacitive Load Drive

DFN PACKAGE

The OPA2313 (dual version) uses the DFN style package (also known as SON); this package is a QFN with contacts on only two sides of the package bottom. This leadless package maximizes printed circuit board (PCB) space and offers enhanced thermal and electrical characteristics through an exposed pad. One of the primary advantages of the DFN package is its low, 0.9-mm height. DFN packages are physically small, have a smaller routing area, improved thermal performance, reduced electrical parasitics, and use a pinout scheme that is consistent with other commonly-used packages, such as SO and MSOP. Additionally, the absence of external leads eliminates bent-lead issues.

The DFN package can easily be mounted using standard PCB assembly techniques. See Application Note, [QFN/SON PCB Attachment \(SLUA271\)](#) and Application Report, [Quad Flatpack No-Lead Logic Packages \(SCBA017\)](#), both available for download from www.ti.com.

NOTE

The exposed leadframe die pad on the bottom of the DFN package should be connected to the most negative potential (V-).

APPLICATION EXAMPLES

GENERAL CONFIGURATIONS

When receiving low-level signals, limiting the bandwidth of the incoming signals into the system is often required. The simplest way to establish this limited bandwidth is to place an RC filter at the noninverting terminal of the amplifier, as [Figure 37](#) shows.

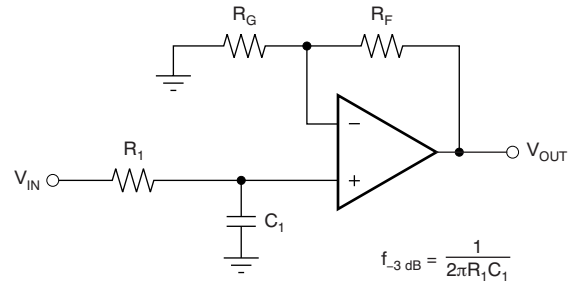

$$f_{-3\text{ dB}} = \frac{1}{2\pi R_1 C_1}$$

$$\frac{V_{\text{OUT}}}{V_{\text{IN}}} = \left(1 + \frac{R_F}{R_G}\right) \left(\frac{1}{1 + sR_1 C_1}\right)$$

Figure 37. Single-Pole Low-Pass Filter

If even more attenuation is needed, a multiple pole filter is required. The Sallen-Key filter can be used for this task, as [Figure 38](#) shows. For best results, the amplifier should have a bandwidth that is eight to 10 times the filter frequency bandwidth. Failure to follow this guideline can result in phase shift of the amplifier.

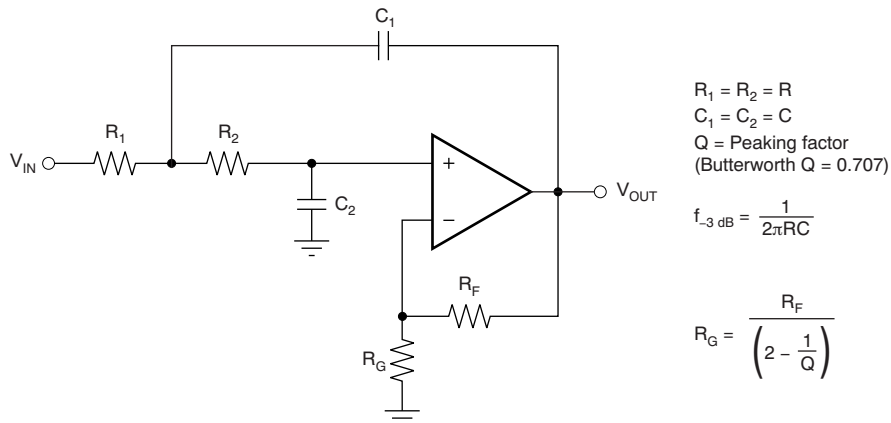

$$R_1 = R_2 = R$$

$$C_1 = C_2 = C$$

$$Q = \text{Peaking factor}$$

(Butterworth $Q = 0.707$)

$$f_{-3\text{ dB}} = \frac{1}{2\pi RC}$$

$$R_G = \frac{R_F}{\left(2 - \frac{1}{Q}\right)}$$

Figure 38. Two-Pole Low-Pass Sallen-Key Filter

REVISION HISTORY

NOTE: Page numbers for previous revisions may differ from page numbers in the current version.

| Changes from Revision B (December 2012) to Revision C | Page |
|--|------|
| • Changed first Open-Loop Gain, A_{OL} typical specification in Electrical Characteristics: +5.5 V table | 3 |
| • Updated Figure 10 | 11 |
| • Updated Figure 19 through Figure 22 | 12 |

| Changes from Revision A (September 2012) to Revision B | Page |
|--|------|
| • Changed title of document | 1 |
| • Changed third paragraph of Description section | 1 |
| • Changed title of Electrical Characteristics: +5.5 V table | 3 |
| • Deleted middle two rows from Input Voltage Range, $CMRR$ parameter in Electrical Characteristics: +5.5 V table | 3 |
| • Changed test conditions of Input Voltage Range, $CMRR$ parameter in Electrical Characteristics: +5.5 V table | 3 |
| • Added footnote to Input Bias Current, I_B and I_{OS} parameters in Electrical Characteristics: +5.5 V table | 3 |
| • Changed Open-Loop Gain, A_{OL} parameter in Electrical Characteristics: +5.5 V table | 3 |
| • Deleted first row from Frequency Response, GBW parameter in Electrical Characteristics: +5.5 V table | 4 |
| • Deleted first row from Frequency Response, SR parameter in Electrical Characteristics: +5.5 V table | 4 |
| • Changed Output, V_O parameter in Electrical Characteristics: +5.5 V table | 4 |
| • Changed Output, I_{SC} parameter in Electrical Characteristics: +5.5 V table | 4 |
| • Changed test conditions for the first row in the Power Supply, I_Q parameter in Electrical Characteristics: +5.5 V table | 4 |
| • Changed Electrical Characteristics: +1.8 V table | 5 |
| • Changed conditions of Electrical Characteristics: +1.8 V table | 5 |
| • Changed last row of Input Voltage Range, $CMRR$ parameter in Electrical Characteristics: +1.8 V table | 5 |
| • Changed footnote to Input Bias Current, I_B and I_{OS} parameters in Electrical Characteristics: +1.8 V table | 5 |
| • Changed Open-Loop Gain, A_{OL} parameter in Electrical Characteristics: +1.8 V table | 5 |
| • Changed Frequency Response, GBW parameter test conditions in Electrical Characteristics: +1.8 V table | 6 |
| • Changed Frequency Response, SR parameter test conditions in Electrical Characteristics: +1.8 V table | 6 |
| • Changed Output, V_O parameter test conditions in Electrical Characteristics: +1.8 V table | 6 |
| • Changed Output, I_{SC} parameter in Electrical Characteristics: +1.8 V table | 6 |
| • Deleted last row from Power Supply, I_Q parameter in Electrical Characteristics: +1.8 V table | 6 |
| • Updated Figure 2 | 10 |

| Changes from Original (September 2012) to Revision A | Page |
|---|------|
| • Changed from product preview to production data | 1 |

PACKAGING INFORMATION

| Orderable Device | Status (1) | Package Type | Package Drawing | Pins | Package Qty | Eco Plan (2) | Lead/Ball Finish | MSL Peak Temp (3) | Op Temp (°C) | Device Marking (4/5) | Samples |
|------------------|---------------|--------------|-----------------|------|-------------|-------------------------|------------------|----------------------|--------------|-------------------------|-------------------------|
| OPA2313ID | ACTIVE | SOIC | D | 8 | 75 | Green (RoHS & no Sb/Br) | CU NIPDAU | Level-2-260C-1 YEAR | -40 to 125 | OP2313 | Samples |
| OPA2313IDGK | ACTIVE | VSSOP | DGK | 8 | 80 | Green (RoHS & no Sb/Br) | CU NIPDAUAG | Level-2-260C-1 YEAR | -40 to 125 | OUSS | Samples |
| OPA2313IDGKR | ACTIVE | VSSOP | DGK | 8 | 2500 | Green (RoHS & no Sb/Br) | CU NIPDAUAG | Level-2-260C-1 YEAR | -40 to 125 | OUSS | Samples |
| OPA2313IDR | ACTIVE | SOIC | D | 8 | 2500 | Green (RoHS & no Sb/Br) | CU NIPDAU | Level-2-260C-1 YEAR | -40 to 125 | OP2313 | Samples |
| OPA2313IDRGR | ACTIVE | SON | DRG | 8 | 3000 | Green (RoHS & no Sb/Br) | CU NIPDAU | Level-2-260C-1 YEAR | -40 to 125 | SDY | Samples |
| OPA2313IDRGT | ACTIVE | SON | DRG | 8 | 250 | Green (RoHS & no Sb/Br) | CU NIPDAU | Level-2-260C-1 YEAR | -40 to 125 | SDY | Samples |
| OPA313IDBVR | ACTIVE | SOT-23 | DBV | 5 | 3000 | Green (RoHS & no Sb/Br) | CU NIPDAU | Level-2-260C-1 YEAR | -40 to 125 | SIE | Samples |
| OPA313IDBVT | ACTIVE | SOT-23 | DBV | 5 | 250 | Green (RoHS & no Sb/Br) | CU NIPDAU | Level-2-260C-1 YEAR | -40 to 125 | SIE | Samples |
| OPA313IDCKR | ACTIVE | SC70 | DCK | 5 | 3000 | Green (RoHS & no Sb/Br) | CU NIPDAU | Level-1-260C-UNLIM | -40 to 125 | SIF | Samples |
| OPA313IDCKT | ACTIVE | SC70 | DCK | 5 | 250 | Green (RoHS & no Sb/Br) | CU NIPDAU | Level-1-260C-UNLIM | -40 to 125 | SIF | Samples |
| OPA4313IPW | ACTIVE | TSSOP | PW | 14 | 90 | Green (RoHS & no Sb/Br) | CU NIPDAU | Level-2-260C-1 YEAR | -40 to 125 | OPA4313 | Samples |
| OPA4313IPWR | ACTIVE | TSSOP | PW | 14 | 2000 | Green (RoHS & no Sb/Br) | CU NIPDAU | Level-2-260C-1 YEAR | -40 to 125 | OPA4313 | Samples |

(1) The marketing status values are defined as follows:

ACTIVE: Product device recommended for new designs.

LIFEBUY: TI has announced that the device will be discontinued, and a lifetime-buy period is in effect.

NRND: Not recommended for new designs. Device is in production to support existing customers, but TI does not recommend using this part in a new design.

PREVIEW: Device has been announced but is not in production. Samples may or may not be available.

OBSOLETE: TI has discontinued the production of the device.

(2) Eco Plan - The planned eco-friendly classification: Pb-Free (RoHS), Pb-Free (RoHS Exempt), or Green (RoHS & no Sb/Br) - please check <http://www.ti.com/productcontent> for the latest availability information and additional product content details.

TBD: The Pb-Free/Green conversion plan has not been defined.

Pb-Free (RoHS): TI's terms "Lead-Free" or "Pb-Free" mean semiconductor products that are compatible with the current RoHS requirements for all 6 substances, including the requirement that lead not exceed 0.1% by weight in homogeneous materials. Where designed to be soldered at high temperatures, TI Pb-Free products are suitable for use in specified lead-free processes.

Pb-Free (RoHS Exempt): This component has a RoHS exemption for either 1) lead-based flip-chip solder bumps used between the die and package, or 2) lead-based die adhesive used between the die and leadframe. The component is otherwise considered Pb-Free (RoHS compatible) as defined above.

Green (RoHS & no Sb/Br): TI defines "Green" to mean Pb-Free (RoHS compatible), and free of Bromine (Br) and Antimony (Sb) based flame retardants (Br or Sb do not exceed 0.1% by weight in homogeneous material)

⁽³⁾ MSL, Peak Temp. -- The Moisture Sensitivity Level rating according to the JEDEC industry standard classifications, and peak solder temperature.

⁽⁴⁾ There may be additional marking, which relates to the logo, the lot trace code information, or the environmental category on the device.

⁽⁵⁾ Multiple Device Markings will be inside parentheses. Only one Device Marking contained in parentheses and separated by a "~" will appear on a device. If a line is indented then it is a continuation of the previous line and the two combined represent the entire Device Marking for that device.

Important Information and Disclaimer:The information provided on this page represents TI's knowledge and belief as of the date that it is provided. TI bases its knowledge and belief on information provided by third parties, and makes no representation or warranty as to the accuracy of such information. Efforts are underway to better integrate information from third parties. TI has taken and continues to take reasonable steps to provide representative and accurate information but may not have conducted destructive testing or chemical analysis on incoming materials and chemicals. TI and TI suppliers consider certain information to be proprietary, and thus CAS numbers and other limited information may not be available for release.

In no event shall TI's liability arising out of such information exceed the total purchase price of the TI part(s) at issue in this document sold by TI to Customer on an annual basis.

TAPE AND REEL INFORMATION



QUADRANT ASSIGNMENTS FOR PIN 1 ORIENTATION IN TAPE



*All dimensions are nominal

| Device | Package Type | Package Drawing | Pins | SPQ | Reel Diameter (mm) | Reel Width W1 (mm) | A0 (mm) | B0 (mm) | K0 (mm) | P1 (mm) | W (mm) | Pin1 Quadrant |
|--------------|--------------|-----------------|------|------|--------------------|--------------------|---------|---------|---------|---------|--------|---------------|
| OPA2313IDGKR | VSSOP | DGK | 8 | 2500 | 330.0 | 12.4 | 5.3 | 3.4 | 1.4 | 8.0 | 12.0 | Q1 |
| OPA2313IDR | SOIC | D | 8 | 2500 | 330.0 | 12.4 | 6.4 | 5.2 | 2.1 | 8.0 | 12.0 | Q1 |
| OPA2313IDRGR | SON | DRG | 8 | 3000 | 330.0 | 12.4 | 3.3 | 3.3 | 1.1 | 8.0 | 12.0 | Q2 |
| OPA2313IDRGT | SON | DRG | 8 | 250 | 180.0 | 12.4 | 3.3 | 3.3 | 1.1 | 8.0 | 12.0 | Q2 |
| OPA313IDBVR | SOT-23 | DBV | 5 | 3000 | 178.0 | 9.0 | 3.3 | 3.2 | 1.4 | 4.0 | 8.0 | Q3 |
| OPA313IDBVT | SOT-23 | DBV | 5 | 250 | 178.0 | 9.0 | 3.23 | 3.17 | 1.37 | 4.0 | 8.0 | Q3 |
| OPA313IDCKR | SC70 | DCK | 5 | 3000 | 178.0 | 9.0 | 2.4 | 2.5 | 1.2 | 4.0 | 8.0 | Q3 |
| OPA4313IPWR | TSSOP | PW | 14 | 2000 | 330.0 | 12.4 | 6.9 | 5.6 | 1.6 | 8.0 | 12.0 | Q1 |

TAPE AND REEL BOX DIMENSIONS

*All dimensions are nominal

| Device | Package Type | Package Drawing | Pins | SPQ | Length (mm) | Width (mm) | Height (mm) |
|--------------|--------------|-----------------|------|------|-------------|------------|-------------|
| OPA2313IDGKR | VSSOP | DGK | 8 | 2500 | 366.0 | 364.0 | 50.0 |
| OPA2313IDR | SOIC | D | 8 | 2500 | 340.5 | 338.1 | 20.6 |
| OPA2313IDRGR | SON | DRG | 8 | 3000 | 367.0 | 367.0 | 35.0 |
| OPA2313IDRGT | SON | DRG | 8 | 250 | 210.0 | 185.0 | 35.0 |
| OPA313IDBVR | SOT-23 | DBV | 5 | 3000 | 180.0 | 180.0 | 18.0 |
| OPA313IDBVT | SOT-23 | DBV | 5 | 250 | 180.0 | 180.0 | 18.0 |
| OPA313IDCKR | SC70 | DCK | 5 | 3000 | 180.0 | 180.0 | 18.0 |
| OPA4313IPWR | TSSOP | PW | 14 | 2000 | 367.0 | 367.0 | 35.0 |

EXAMPLE BOARD LAYOUT

DBV0005A

SOT-23 - 1.45 mm max height

SMALL OUTLINE TRANSISTOR

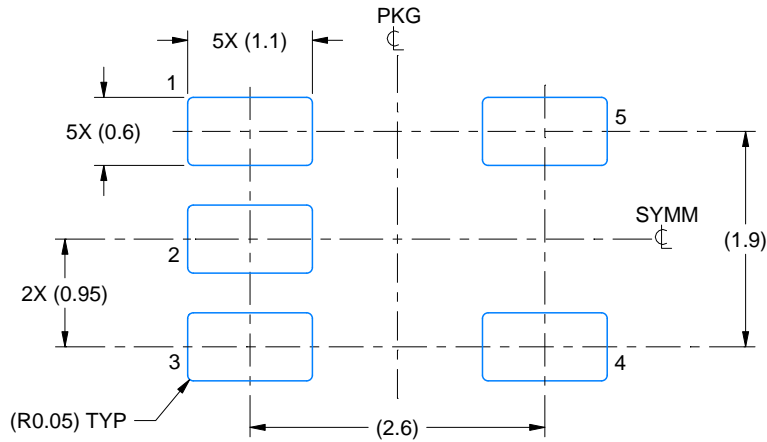

LAND PATTERN EXAMPLE
EXPOSED METAL SHOWN
SCALE:15X

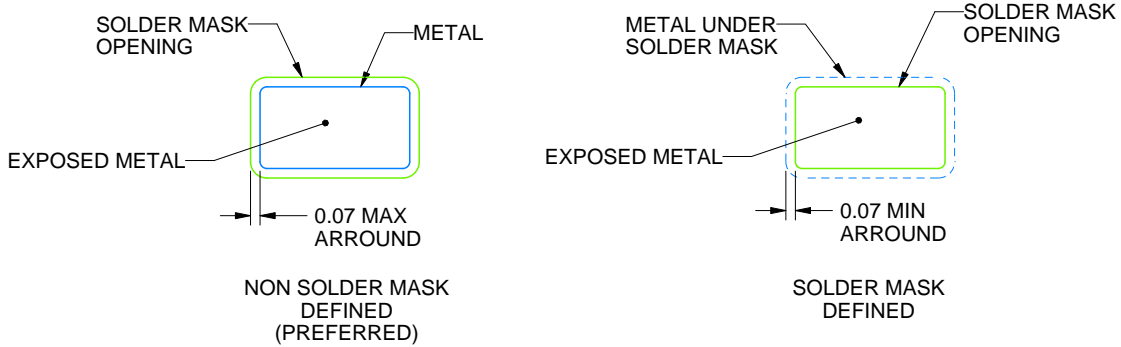

SOLDER MASK DETAILS

4214839/E 09/2019

NOTES: (continued)

- 5. Publication IPC-7351 may have alternate designs.
- 6. Solder mask tolerances between and around signal pads can vary based on board fabrication site.

EXAMPLE STENCIL DESIGN

DBV0005A

SOT-23 - 1.45 mm max height

SMALL OUTLINE TRANSISTOR

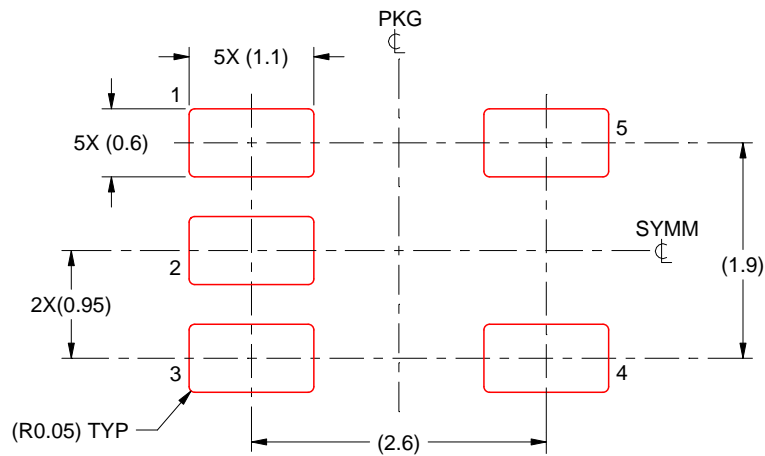

SOLDER PASTE EXAMPLE
BASED ON 0.125 mm THICK STENCIL
SCALE:15X

4214839/E 09/2019

NOTES: (continued)

7. Laser cutting apertures with trapezoidal walls and rounded corners may offer better paste release. IPC-7525 may have alternate design recommendations.
8. Board assembly site may have different recommendations for stencil design.

PW (R-PDSO-G14)

PLASTIC SMALL OUTLINE



4211284-2/G 08/15

- NOTES:
- All linear dimensions are in millimeters.
 - This drawing is subject to change without notice.
 - Publication IPC-7351 is recommended for alternate designs.
 - Laser cutting apertures with trapezoidal walls and also rounding corners will offer better paste release. Customers should contact their board assembly site for stencil design recommendations. Refer to IPC-7525 for other stencil recommendations.
 - Customers should contact their board fabrication site for solder mask tolerances between and around signal pads.



D0008A

PACKAGE OUTLINE

SOIC - 1.75 mm max height

SMALL OUTLINE INTEGRATED CIRCUIT



4214825/C 02/2019

NOTES:

- Linear dimensions are in inches [millimeters]. Dimensions in parenthesis are for reference only. Controlling dimensions are in inches. Dimensioning and tolerancing per ASME Y14.5M.
- This drawing is subject to change without notice.
- This dimension does not include mold flash, protrusions, or gate burrs. Mold flash, protrusions, or gate burrs shall not exceed $.006$ [0.15] per side.
- This dimension does not include interlead flash.
- Reference JEDEC registration MS-012, variation AA.

EXAMPLE BOARD LAYOUT

D0008A

SOIC - 1.75 mm max height

SMALL OUTLINE INTEGRATED CIRCUIT



LAND PATTERN EXAMPLE
EXPOSED METAL SHOWN
SCALE:8X



SOLDER MASK DETAILS

4214825/C 02/2019

NOTES: (continued)

- 6. Publication IPC-7351 may have alternate designs.
- 7. Solder mask tolerances between and around signal pads can vary based on board fabrication site.

EXAMPLE STENCIL DESIGN

D0008A

SOIC - 1.75 mm max height

SMALL OUTLINE INTEGRATED CIRCUIT



SOLDER PASTE EXAMPLE
BASED ON .005 INCH [0.125 MM] THICK STENCIL
SCALE:8X

4214825/C 02/2019

NOTES: (continued)

8. Laser cutting apertures with trapezoidal walls and rounded corners may offer better paste release. IPC-7525 may have alternate design recommendations.
9. Board assembly site may have different recommendations for stencil design.

DGK (S-PDSO-G8)

PLASTIC SMALL-OUTLINE PACKAGE

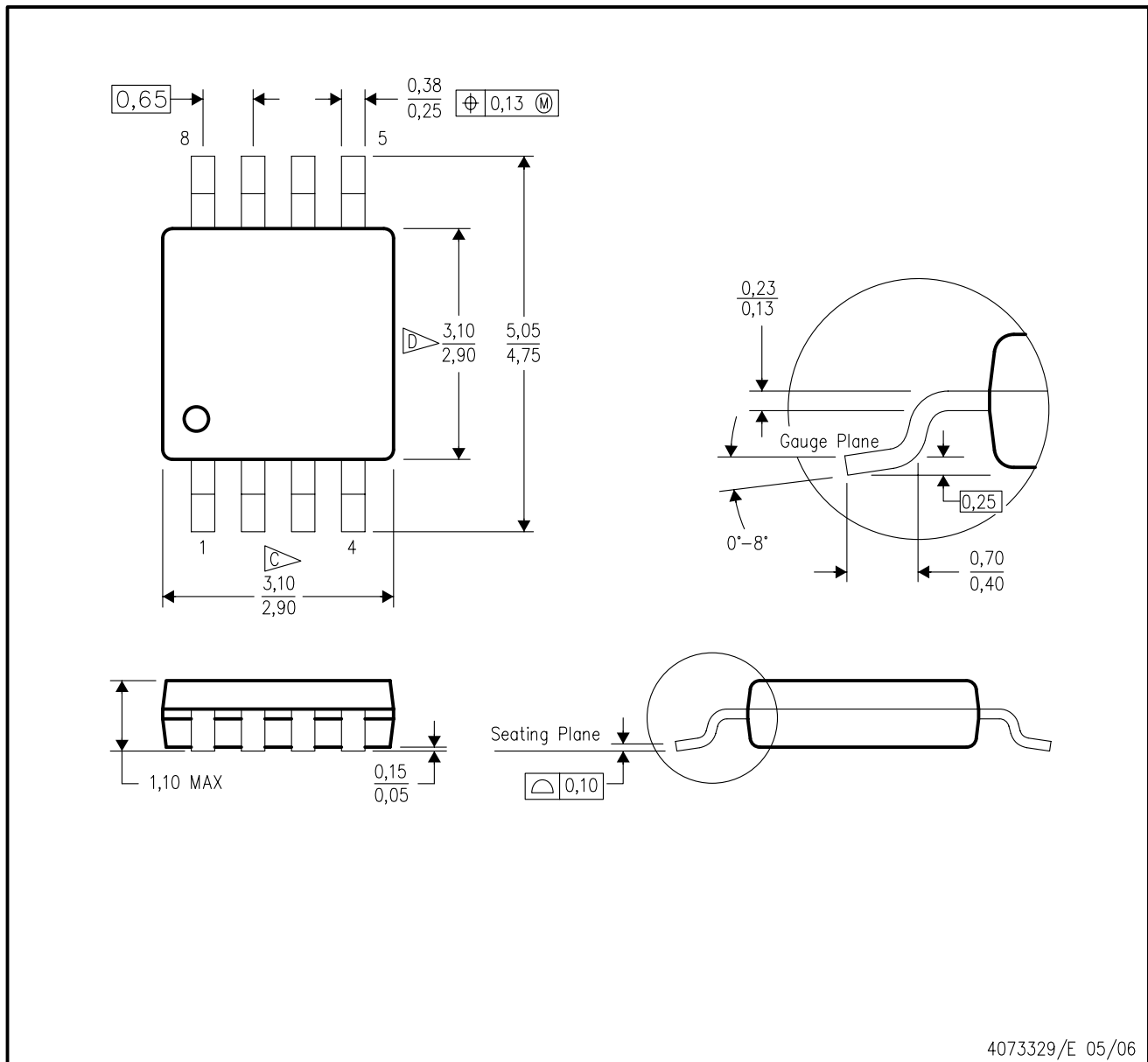

4073329/E 05/06

- NOTES:
- A. All linear dimensions are in millimeters.
 - B. This drawing is subject to change without notice.
 - C. Body length does not include mold flash, protrusions, or gate burrs. Mold flash, protrusions, or gate burrs shall not exceed 0.15 per end.
 - D. Body width does not include interlead flash. Interlead flash shall not exceed 0.50 per side.
 - E. Falls within JEDEC MO-187 variation AA, except interlead flash.



- NOTES:
- A. All linear dimensions are in millimeters.
 - B. This drawing is subject to change without notice.
 - C. Publication IPC-7351 is recommended for alternate designs.
 - D. Laser cutting apertures with trapezoidal walls and also rounding corners will offer better paste release. Customers should contact their board assembly site for stencil design recommendations. Refer to IPC-7525 for other stencil recommendations.
 - E. Customers should contact their board fabrication site for solder mask tolerances between and around signal pads.

DRG (S-PWSON-N8)

PLASTIC SMALL OUTLINE NO-LEAD

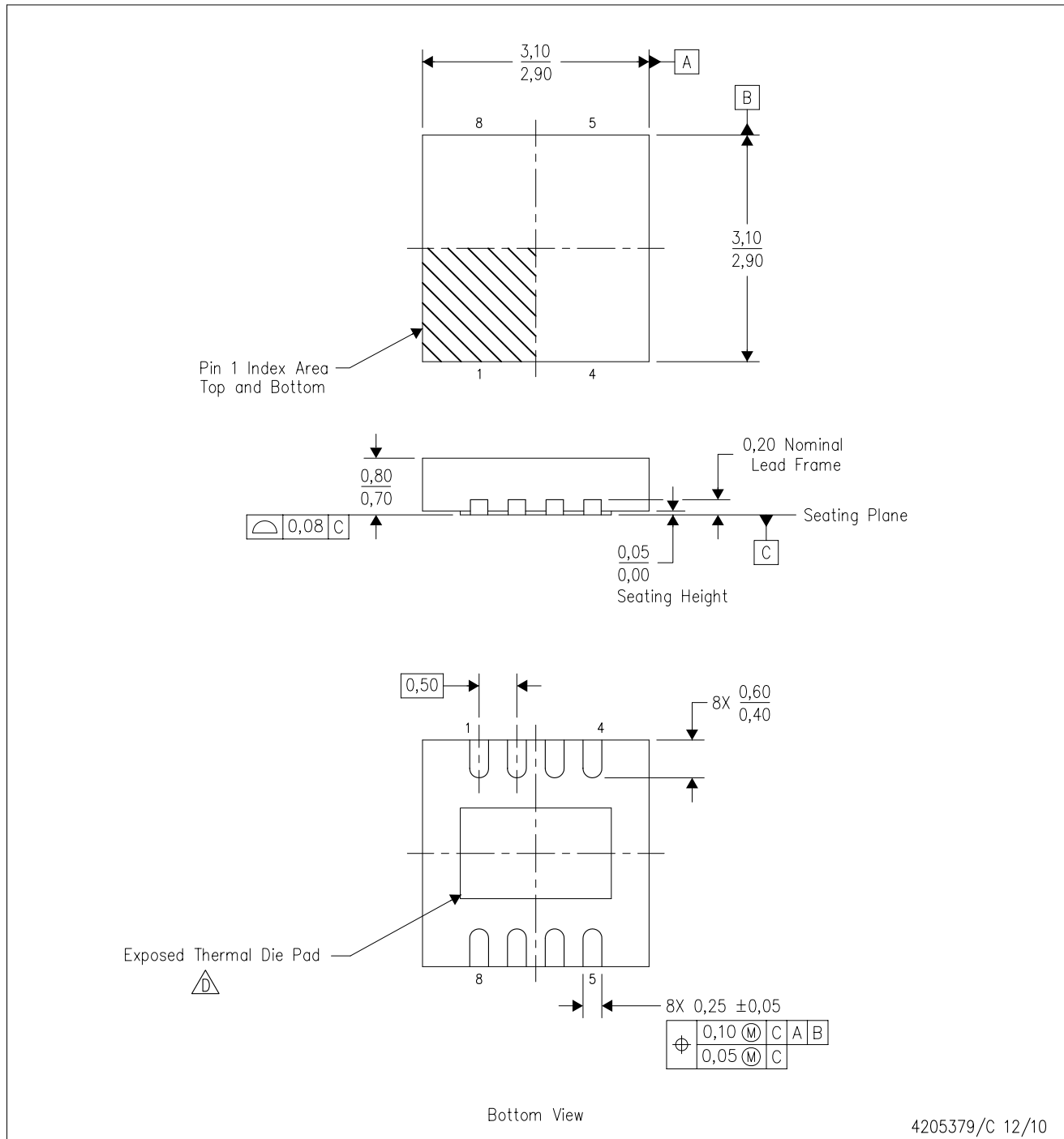

- NOTES:
- A. All linear dimensions are in millimeters. Dimensioning and tolerancing per ASME Y14.5M-1994.
 - B. This drawing is subject to change without notice.
 - C. SON (Small Outline No-Lead) package configuration.
 - D. The package thermal pad must be soldered to the board for thermal and mechanical performance. See the Product Data Sheet for details regarding the exposed thermal pad dimensions.
 - E. JEDEC MO-229 package registration pending.

THERMAL PAD MECHANICAL DATA

DRG (S-PWSON-N8)

PLASTIC SMALL OUTLINE NO-LEAD

THERMAL INFORMATION

This package incorporates an exposed thermal pad that is designed to be attached directly to an external heatsink. The thermal pad must be soldered directly to the printed circuit board (PCB). After soldering, the PCB can be used as a heatsink. In addition, through the use of thermal vias, the thermal pad can be attached directly to the appropriate copper plane shown in the electrical schematic for the device, or alternatively, can be attached to a special heatsink structure designed into the PCB. This design optimizes the heat transfer from the integrated circuit (IC).

For information on the Quad Flatpack No-Lead (QFN) package and its advantages, refer to Application Report, QFN/SON PCB Attachment, Texas Instruments Literature No. SLUA271. This document is available at www.ti.com.

The exposed thermal pad dimensions for this package are shown in the following illustration.

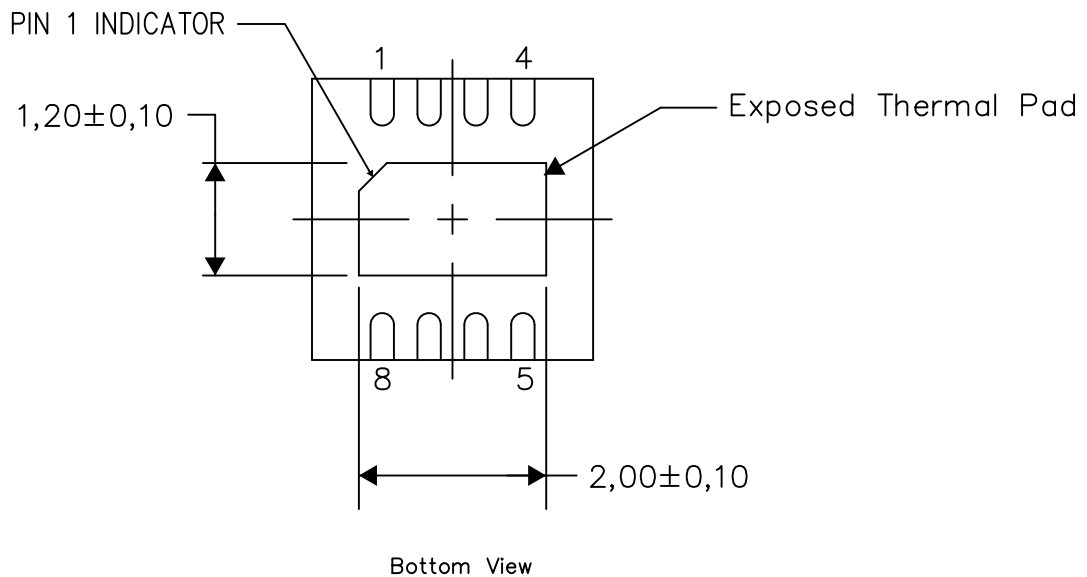

Exposed Thermal Pad Dimensions

4206881-2/1 03/15

NOTE: All linear dimensions are in millimeters

DRG (S-PWSON-N8)

PLASTIC SMALL OUTLINE NO-LEAD

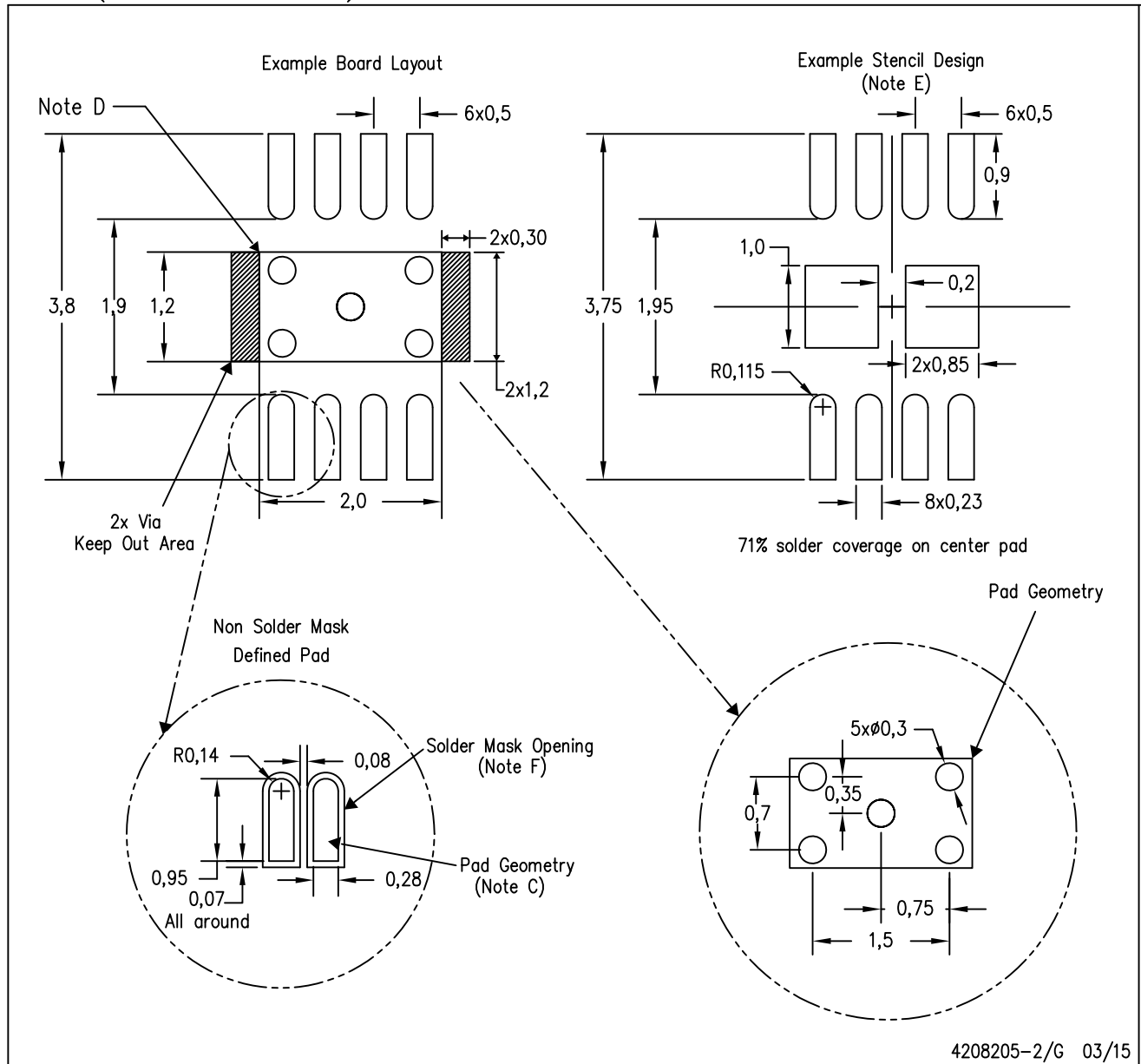

4208205-2/G 03/15

- NOTES:
- All linear dimensions are in millimeters.
 - This drawing is subject to change without notice.
 - Publication IPC-SM-782 is recommended for alternate designs.
 - This package is designed to be soldered to a thermal pad on the board. Refer to Application Note, Quad Flat-Pack Packages, Texas Instruments Literature No. SLUA271, and also the Product Data Sheets for specific thermal information, via requirements, and recommended board layout. These documents are available at www.ti.com <<http://www.ti.com>>.
 - Laser cutting apertures with trapezoidal walls and also rounding corners will offer better paste release. Customers should contact their board assembly site for stencil design recommendations. Refer to IPC 7525 for stencil design considerations.
 - Customers should contact their board fabrication site for minimum solder mask web tolerances between signal pads.

DCK (R-PDSO-G5)

PLASTIC SMALL-OUTLINE PACKAGE

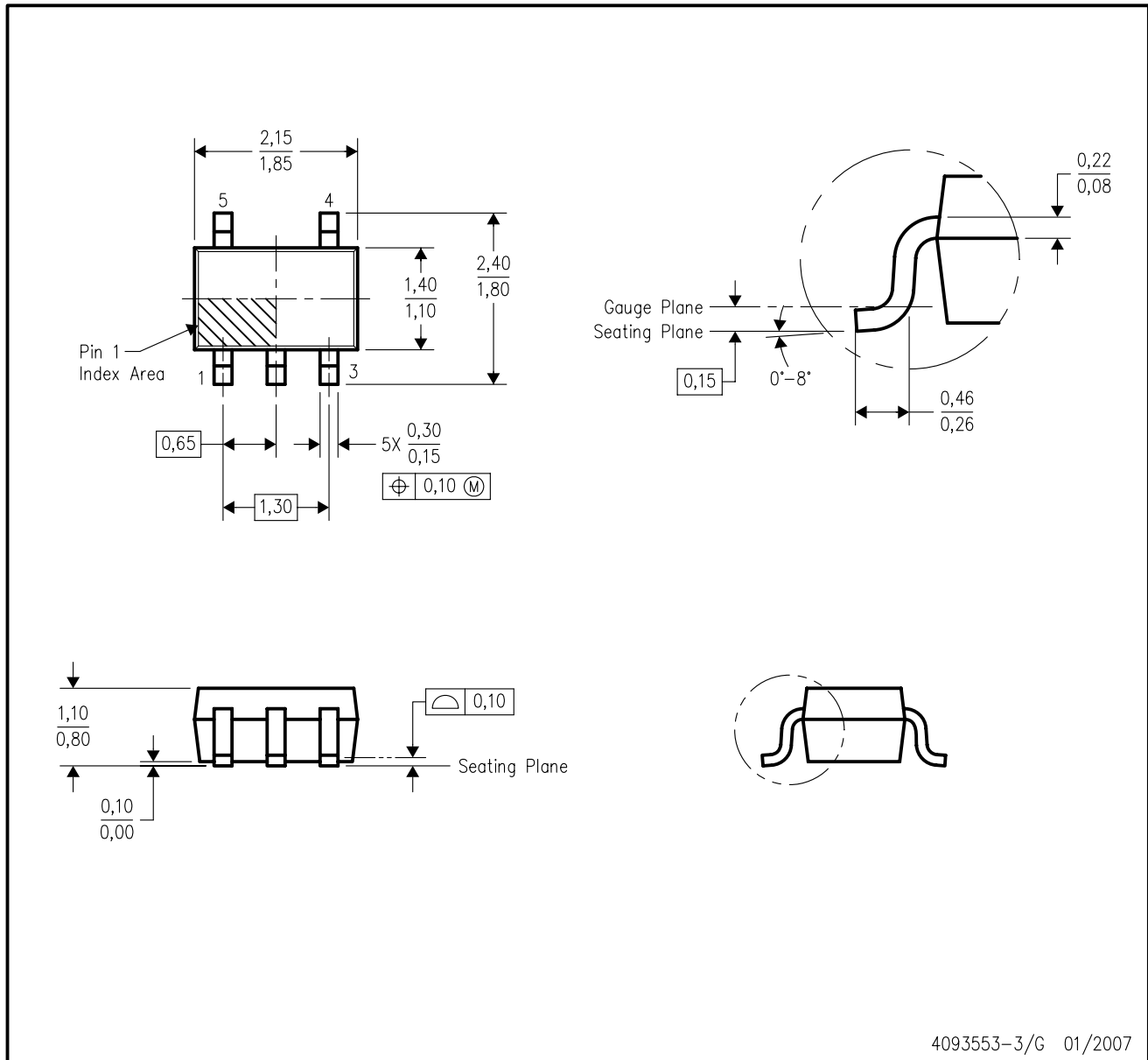

- NOTES:
- A. All linear dimensions are in millimeters.
 - B. This drawing is subject to change without notice.
 - C. Body dimensions do not include mold flash or protrusion. Mold flash and protrusion shall not exceed 0.15 per side.
 - D. Falls within JEDEC MO-203 variation AA.

DCK (R-PDSO-G5)

PLASTIC SMALL OUTLINE

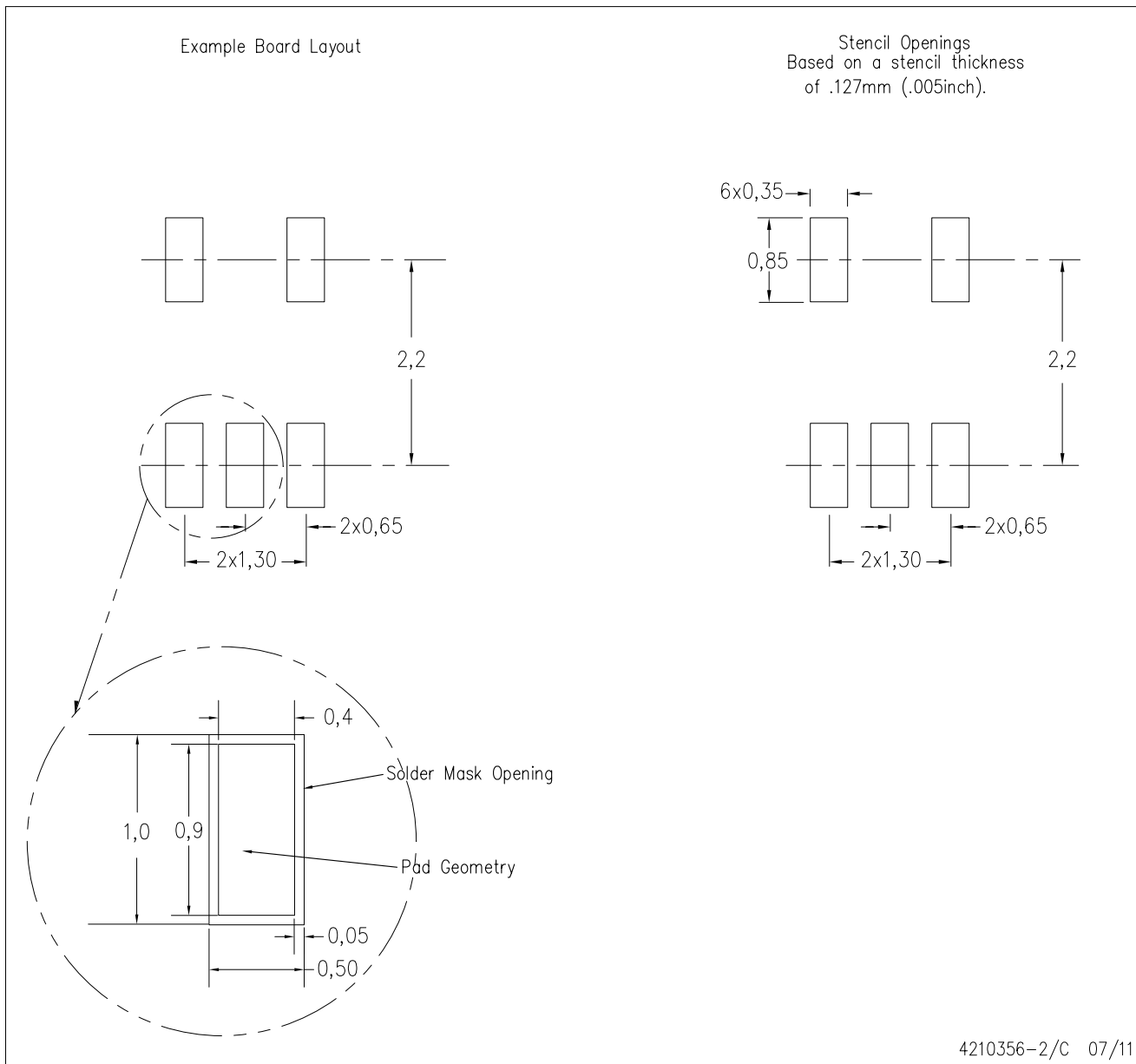

- NOTES:
- All linear dimensions are in millimeters.
 - This drawing is subject to change without notice.
 - Customers should place a note on the circuit board fabrication drawing not to alter the center solder mask defined pad.
 - Publication IPC-7351 is recommended for alternate designs.
 - Laser cutting apertures with trapezoidal walls and also rounding corners will offer better paste release. Customers should contact their board assembly site for stencil design recommendations. Example stencil design based on a 50% volumetric metal load solder paste. Refer to IPC-7525 for other stencil recommendations.

IMPORTANT NOTICE AND DISCLAIMER

TI PROVIDES TECHNICAL AND RELIABILITY DATA (INCLUDING DATASHEETS), DESIGN RESOURCES (INCLUDING REFERENCE DESIGNS), APPLICATION OR OTHER DESIGN ADVICE, WEB TOOLS, SAFETY INFORMATION, AND OTHER RESOURCES "AS IS" AND WITH ALL FAULTS, AND DISCLAIMS ALL WARRANTIES, EXPRESS AND IMPLIED, INCLUDING WITHOUT LIMITATION ANY IMPLIED WARRANTIES OF MERCHANTABILITY, FITNESS FOR A PARTICULAR PURPOSE OR NON-INFRINGEMENT OF THIRD PARTY INTELLECTUAL PROPERTY RIGHTS.

These resources are intended for skilled developers designing with TI products. You are solely responsible for (1) selecting the appropriate TI products for your application, (2) designing, validating and testing your application, and (3) ensuring your application meets applicable standards, and any other safety, security, or other requirements. These resources are subject to change without notice. TI grants you permission to use these resources only for development of an application that uses the TI products described in the resource. Other reproduction and display of these resources is prohibited. No license is granted to any other TI intellectual property right or to any third party intellectual property right. TI disclaims responsibility for, and you will fully indemnify TI and its representatives against, any claims, damages, costs, losses, and liabilities arising out of your use of these resources.

TI's products are provided subject to TI's Terms of Sale (www.ti.com/legal/termsofsale.html) or other applicable terms available either on ti.com or provided in conjunction with such TI products. TI's provision of these resources does not expand or otherwise alter TI's applicable warranties or warranty disclaimers for TI products.

Mailing Address: Texas Instruments, Post Office Box 655303, Dallas, Texas 75265
Copyright © 2019, Texas Instruments Incorporated