

T-41-73



Optoelectronics Division
TRW Electronic Components Group

Product Bulletin 5282
January 1985

Reflective Object Sensor Type OPB253A

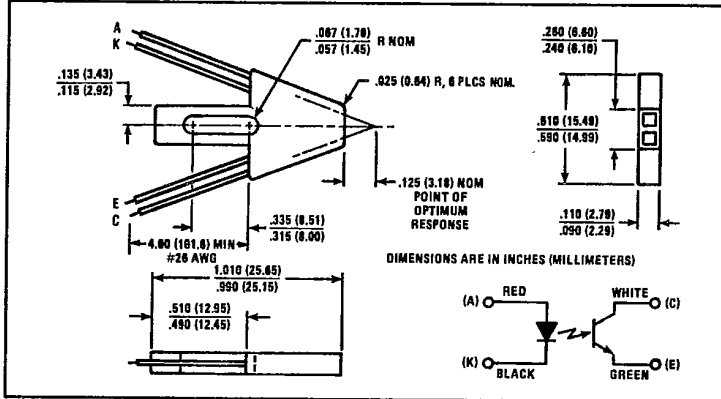
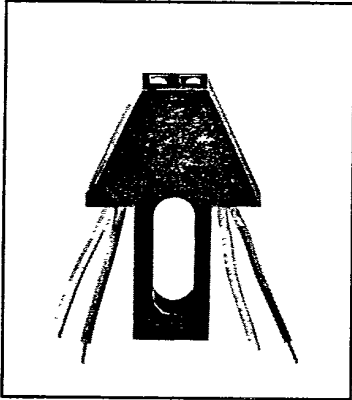

Features

- Phototransistor output
- Low profile to facilitate stacking
- Low cost plastic housing
- 4.0 inches (101.6 mm) minimum length lead wire

Description

The OPB253A consists of an infrared emitting diode and an NPN silicon phototransistor mounted side-by-side on converging optical axes, in a black plastic housing. The phototransistor responds to radiation from the LED only when a reflective object passes within its field of view.

The OPB253A utilizes an OP123 or OP223 LED and an OP600 family sensor. Leads are #26 AWG, teflon insulation, 4.0" (101.6 mm) minimum length, stripped and tinned.

Absolute Maximum Ratings (T_A = 25°C unless otherwise noted)

Storage Temperature Range	-40°C to +125°C
Operating Temperature Range	-40°C to +100°C

Input Diode

Reverse Voltage	2.0 V
Continuous Forward Current	50 mA
Power Dissipation	80 mW ⁽¹⁾

Output Phototransistor

Collector-Emitter Voltage	25 V
Emitter-Collector Voltage	5.0 V
Power Dissipation	50 mW ⁽²⁾

Notes:

- (1) Derate linearly 1.07 mW/°C above 25°C.
- (2) Derate linearly 0.67 mW/°C above 25°C.
- (3) Measured using an Eastman Kodak neutral white test card having 90% diffuse reflectance as a reflecting surface.
- (4) Crosstalk (I_{cx}) is the collector current measured with the indicated current in the input diode and with no reflecting surface.
- (5) Lower curve is based on a calculated worst case condition rather than the conventional -2σ limit.
- (6) d is the distance from the assembly head to the reflective surface.

T-41-73

Type OPB253A

Electrical Characteristics (T_A = 25°C unless otherwise noted)

Symbol	Parameter	Min.	Max.	Units	Test Conditions
Input Diode					
V _F	Forward Voltage		1.70	V	I _F = 50 mA
I _R	Reverse Current		100	μA	V _R = 2.0 V
Output Phototransistor					
V _{(BR)CEO}	Collector-Emitter Breakdown Voltage	25		V	I _C = 100 μA
V _{(BR)ECO}	Emitter-Collector Breakdown Voltage	5.0		V	I _E = 100 μA
I _{CEO}	Collector Dark Current		100	nA	V _{CE} = 10.0 V, I _F = 0, E ₀ ≤ 0.1 μW/cm ²
Combined					
I _{C(OH)}	On-State Collector Current	25		μA	I _F = 40 mA, V _{CE} = 5.0 V, d = 0.20 in. (5.08 mm). ⁽⁶⁾ See Note 3.
I _{CX}	Crosstalk		2.0	μA	I _F = 40 mA, V _{CE} = 5.0 V. No Reflecting Surface
V _{CE(SAT)}	Collector-Emitter Saturation Voltage		0.40	V	I _F = 40 mA, I _C = 10.0 μA, d = 0.20 in. (5.08 mm). ⁽⁶⁾ See Note 3.

Typical Performance Curves

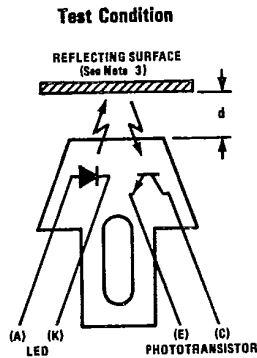
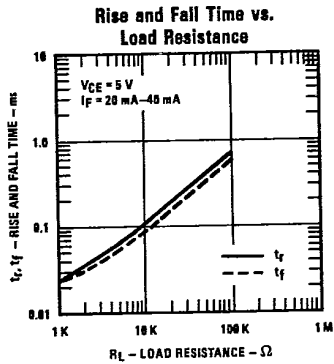
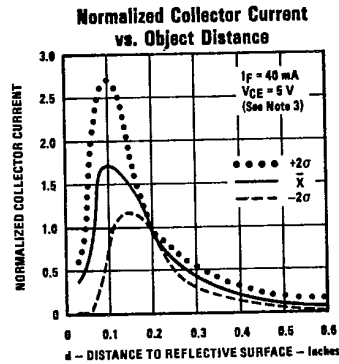
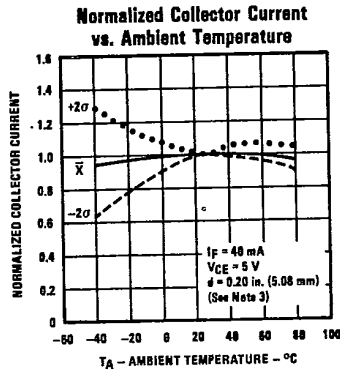
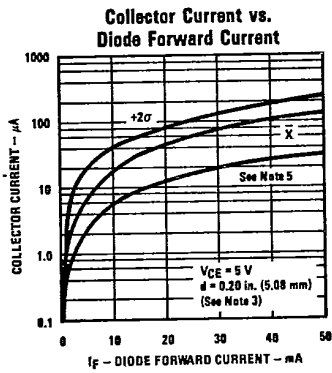

TRW reserves the right to make changes at any time in order to improve design and to supply the best product possible.
 Optoelectronics Division, TRW Electronic Components Group, 1215 W. Crosby Rd., Carrollton, TX 75006 (214) 323-2200, TLX 6716032 or 215849
 © TRW Inc. 1985, 1982. TRW is the name and mark of TRW Inc. Printed in U.S.A.