

Reflective Color Sensor Assembly OPB780Z

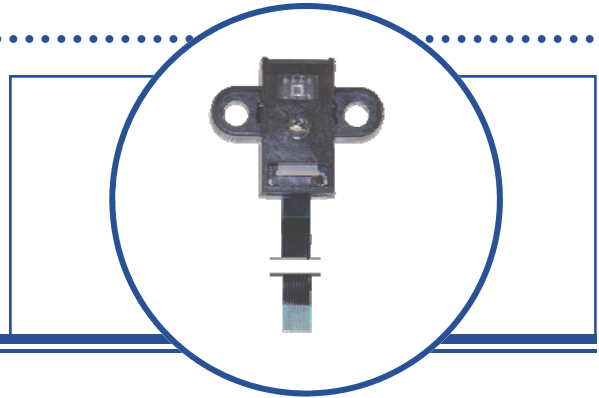

Features:

- High-resolution conversion of light intensity to frequency
- Selectable color output frequency
- Communicates directly with a microcontroller
- Sensor power supply operation (2.7 V to 5.5 V)
- LED power separate input
- Includes LED, Sensor and interface cable



Description:

The **OPB780Z** color sensor uses a light-to-frequency converter that combines 64 configurable silicon photodiodes (on a 144 um center and measuring 120 um x 120 um each), with a white LED in a small, lightweight package that makes it ideal for using in miniature applications.

The output is a square wave (50% duty cycle) with a frequency directly proportional to reflected light intensity (irradiance).

The light-to-frequency converter reads an 8 x 8 array of photodiodes that consists of four groups of 16 photodiodes each, segregated by color: 16 photodiodes with red filters, 16 photodiodes with green filters, 16 photodiodes with blue filters and 16 clear photodiodes with no filters. Each color's group of 16 photodiodes is interdigitated to minimize the effect of non-uniformity of the incident irradiance. Each color's group is also connected in parallel. The type of photodiode used during operation is pin-selectable.

The output of the device is designed to drive a standard TTL or CMOS logic input over short distances.

The internal photodiode used by the device is controlled by two logic inputs, S2 and S3. See page 4 for more information.

A 10 " [25.4 cm] Flat Flexible Cable (FFC) is included for easy hook-up. The FFC is designed to interface with an AVX (ELCO) part number 04 6249 0080 00 800 connector.

For more information, contact your local representative or OPTEK.

Applications:

- Photographic equipment
- Colormetry
- Chemical analyzers
- Display contrast controls
- High resolution digital measurement of light intensity

Block Diagram

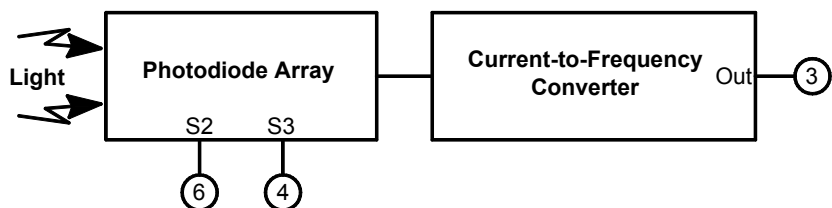

RoHS

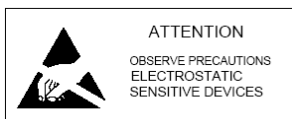

Ordering Information

Ordering Information	
OPB780Z	OPB780 with 10" Long Flat Flex Cable
KA3128	10" Long Flat Flex Cable

OPTEK reserves the right to make changes at any time in order to improve design and to supply the best product possible.

Absolute Maximum Ratings^{1,2} (T_A = 25° C unless otherwise noted)

Operating Temperature	T _{OPR} = -30° C to +85° C
Storage Temperature	T _{STG} = -30° C to +85° C

LED—Absolute Maximum Ratings^{1,2} (T_A = 25° C unless otherwise noted)

Reverse Voltage	V _R = 5 V
Forward Current	I _F = 30 mA
Power Dissipation	P _D = 120 mW
Peak Forward Current	I _{FP} = 100 mA

Sensor—Absolute Maximum Ratings^{1,2} (over operating free-air temperature range unless otherwise noted)

Supply Voltage(V _{DD})	6 V
Input Voltage (all inputs, V _I)	-0.3 V to V _{DD} + 0.3 V

Notes:

- Stresses beyond those linked under “absolute maximum rating” may cause permanent damage to device.** These are only stress ratings, and functional operating of the device at these (or any other) conditions beyond those indicated in the Recommended Operating Conditions table shown above may affect the device’s reliability.
- All voltage values are with respect to GND.

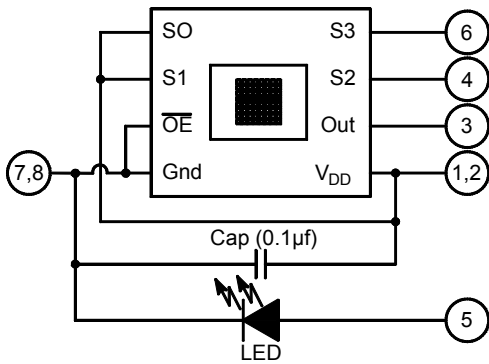

**DO NOT LOOK DIRECTLY AT LED
WITH UNSHIELDED EYES OR
DAMAGE TO RETINA MAY OCCUR.**

Pin Name	Pin #	Description
V _{DD}	1, 2	Supply voltage
OUT	3	Output Frequency (F _O)
S2	4	Photodiode type selection input
LED Anode	5	LED input
S3	6	Photodiode type selection input
GND	7, 8	Power supply ground

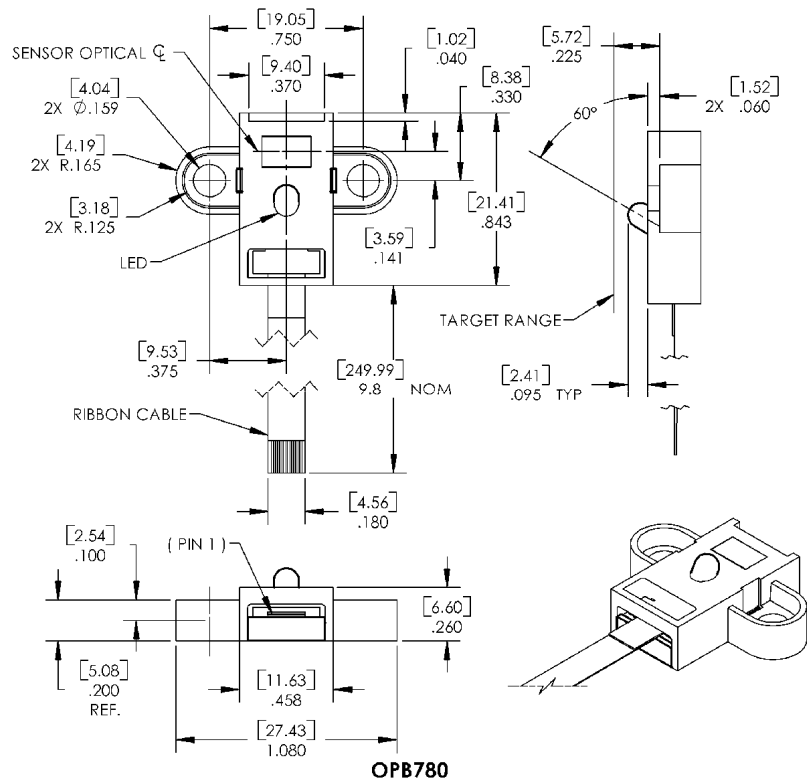

OPTEK reserves the right to make changes at any time in order to improve design and to supply the best product possible.

LED

Electro-Optical Characteristics of LED¹ ($T_A = 25^\circ\text{C}$ unless otherwise noted) (See OVLAW4CB6 for more info.)

SYMBOL	PARAMETER	MIN	TYP	MAX	UNITS	TEST CONDITIONS
$I_V^{(1)}$	Luminous Intensity	-	1.0	-	cd	$I_F = 20\text{ mA}$
V_F	Forward Voltage	2.8	3.4	3.9	V	$I_F = 5\text{ mA}$
I_R	Reverse Current	-	-	10	μA	$V_R = 5\text{ V}$

Sensor

Recommended Operating Conditions¹

SYMBOL	PARAMETER	MIN	TYP	MAX	UNITS	RECOMMENDED CONDITIONS
V_{DD}	Supply Voltage	2.7	5	5.5	V	-
V_{IH}	High-Level Input Voltage	2.0	-	V_{DD}	V	$V_{DD} = 2.7\text{ V to } 5.5\text{ V}$
V_{IL}	Low-Level Input Voltage	0.0	-	0.8	V	$V_{DD} = 2.7\text{ V to } 5.5\text{ V}$
T_A	Operating Free-Air Temperature Range	-40	-	+70	$^\circ\text{C}$	-

Sensor

Electrical Characteristics¹ ($T_A = 25^\circ\text{C}$, $V_{DD} = 5\text{ V}$ unless otherwise noted)

SYMBOL	PARAMETER	MIN	TYP	MAX	UNITS	TEST CONDITIONS
V_{OH}	High-Level Output Voltage ³	-	4.5	-	V	$I_{OH} = -4\text{ mA}$
V_{OL}	Low-Level Output Voltage ³	-	0.25	-	V	$I_{OL} = 4\text{ mA}$
I_{IH}	High-Level Input Current	-	-	5	μ	-
I_{IL}	Low-Level Input Current	-	-	5	μ	-
I_{DD}	Supply Current	-	2	3	mA	Power on
-	Full-Scale Frequency ²	-	600	-	kHz	-
-	Temperature Coefficient of Output Frequency	-	± 200	-	ppm/ $^\circ\text{C}$	$\lambda \leq 700\text{ nm}$, $-25^\circ\text{C} \leq T_A \leq 70^\circ\text{C}$ / $\pm 200\text{ ppm}/^\circ\text{C}$
t_r, t_f	Typical Temperature Rise Time Typical Temperature Fall Time	-	100	-	$\mu\text{ sec.}$	-

Notes:

- (1) All voltage values are with respect to GND.
- (2) Full-scale frequency is the maximum operating frequency of the device without saturation.
- (3) Output interface of device is designed to drive a standard TTL or CMOS logic input over short distances. If lines greater than 12 inches are used on output, a buffer or line driver is recommended.

OPTEK reserves the right to make changes at any time in order to improve design and to supply the best product possible.

Coupled Characteristics¹ (VDD = 5 V, T_A = 25 °C, I_F = 5mA)

SYMBOL	PARAMETER	RED	GREEN	BLUE	CLEAR	PARAMETER
		S2=L/S3=L	S2=H/S3=H	S2=L/S3=H	S2=H/S3=L	
TYPICAL						
kHz	Output Frequency See note ⁽⁹⁾	16.0 K	3.5 K	2.7 K	23.9 K	I _F = 5 mA, D = 0.225 inch, with red target
		4.0 K	7.5 K	5.2 K	19.9 K	I _F = 5 mA, D = 0.225 inch, with green target
		2.2 K	3.4 K	9.5 K	16.1 K	I _F = 5 mA, D = 0.225 inch, with blue target
		35.7 K	35.8 K	39.3 K	126.0 K	I _F = 5 mA, D = 0.225 inch, with white target

Notes:

(1) All voltage values are with respect to GND.

**OPB780Z Sensor -
 Typical Electro-Optical Characteristics Curves**

**Spectral Response
 with Hoya CM230 Filter (not included)**

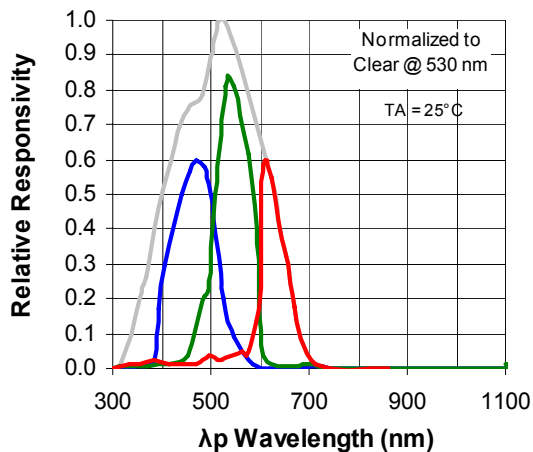

Spectral Response

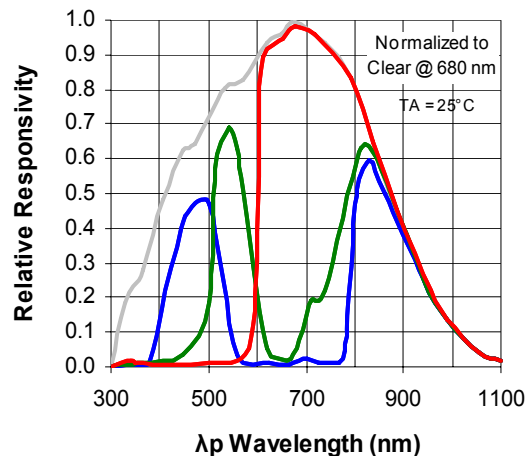

OPTEK reserves the right to make changes at any time in order to improve design and to supply the best product possible.

OPB780Z Sensor & LED - Typical Electro-Optical Characteristics Curves

Sensor Radiation Diagram

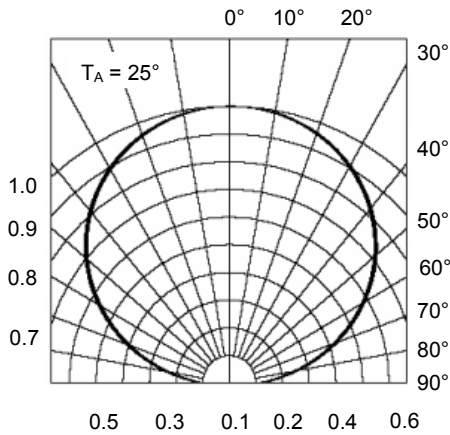

Forward Current vs Chromaticity Coordinate

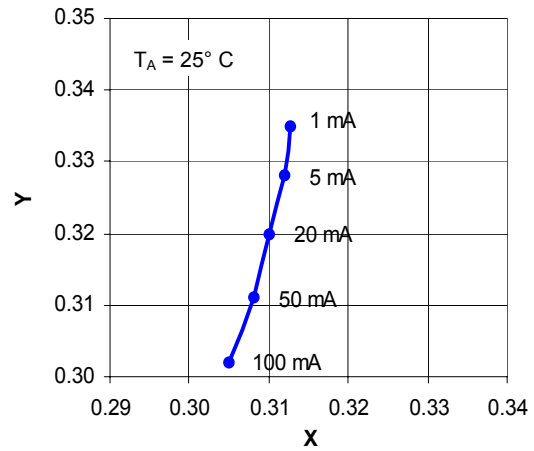

LED Spectrum

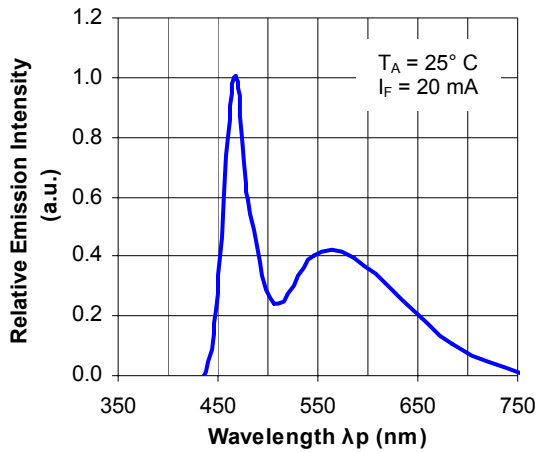

Ambient Temperature vs Chromaticity Coordinate

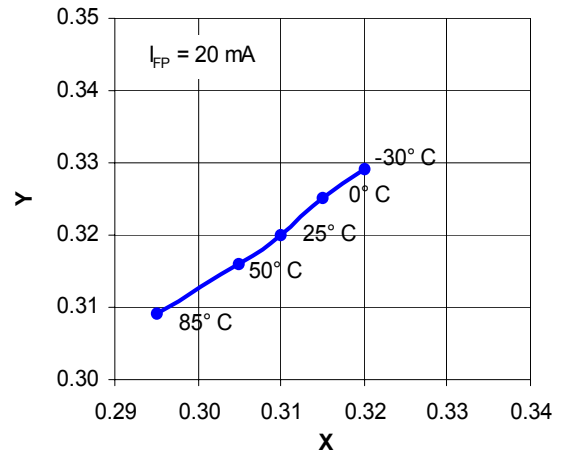

LED Directivity

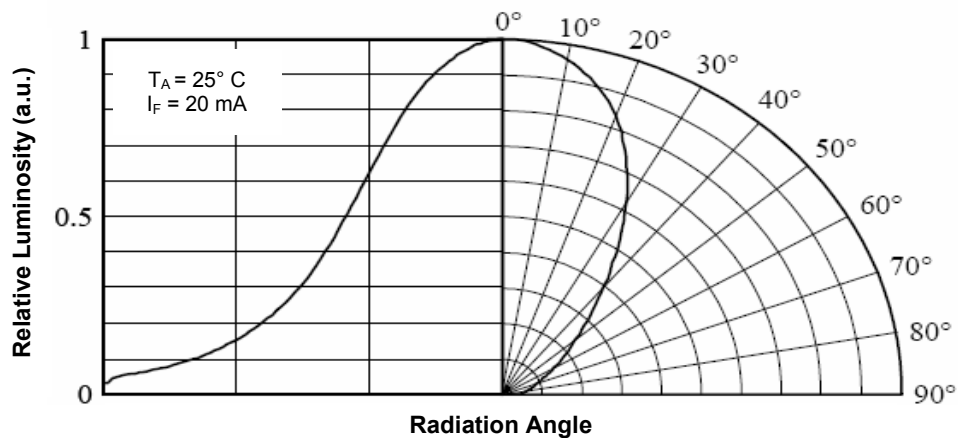

OPTEK reserves the right to make changes at any time in order to improve design and to supply the best product possible.

OPB780Z LED - Typical Electro-Optical Characteristics Curves

Forward Voltage vs Forward Current

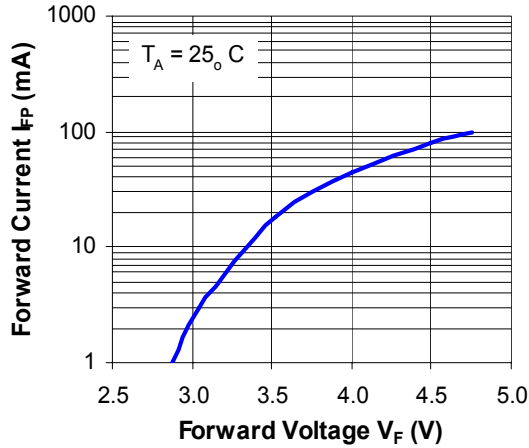

Forward Current vs Relative Luminosity

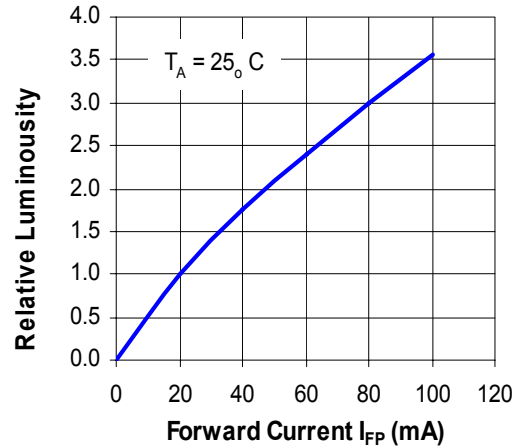

Duty Ratio vs Allowable Forward Current

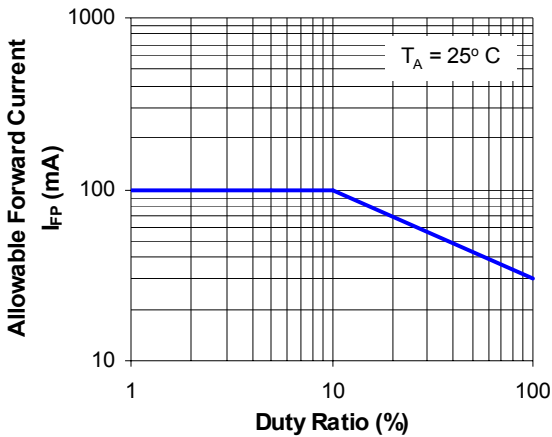

Ambient Temperature vs Forward Voltage

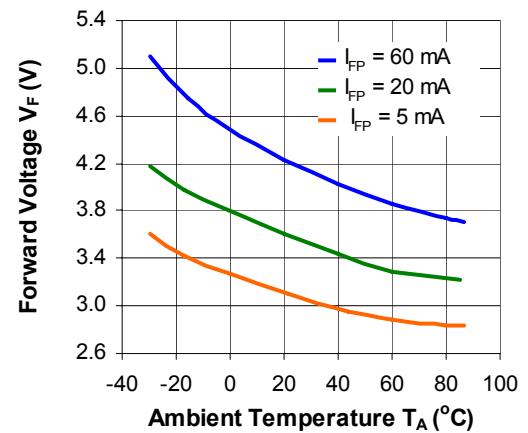

Ambient Temperature vs Relative Luminosity

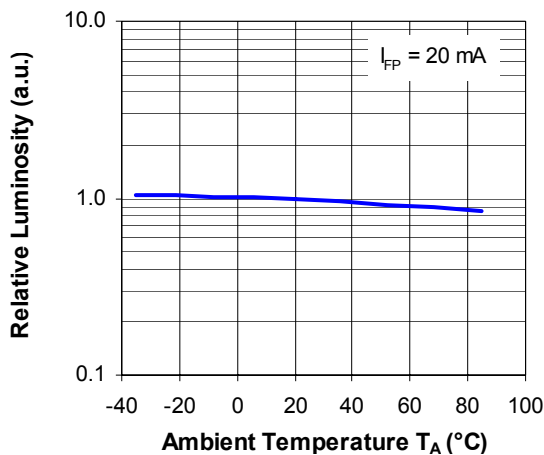

Ambient Temperature vs Allowable Forward Current

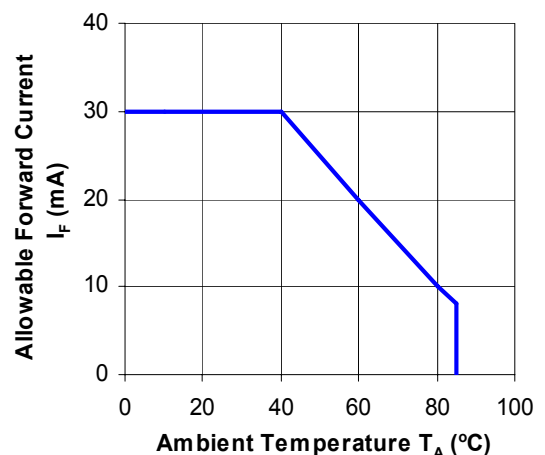

OPTeK reserves the right to make changes at any time in order to improve design and to supply the best product possible.