

T-41-83

# Optically Coupled Isolators

## Types OPI2151, OPI2251

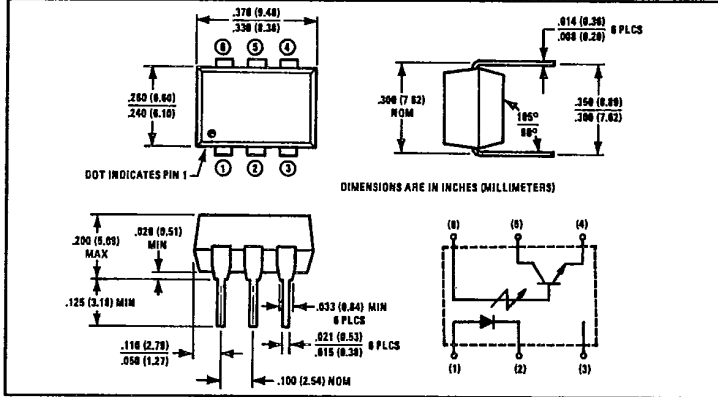
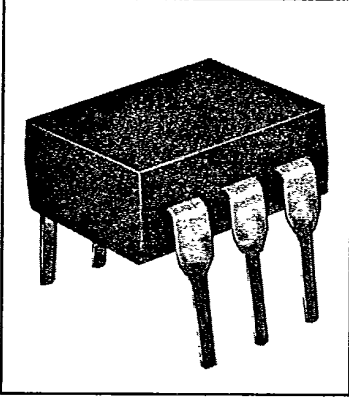

**Features**

- 1500 or 2500 volt isolation
- High current transfer ratio
- Low cost 6 pin dual-in-line package
- UL recognized File No. E58730

**Description**

The OPI2151 and OPI2251 each consist of a gallium arsenide infrared light emitting diode coupled to an NPN silicon phototransistor mounted in a six pin dual-in-line package. The OPI2151 and OPI2251 are identical except for input-to-output isolation voltage.

**Absolute Maximum Ratings** (T<sub>A</sub> = 25°C unless otherwise noted)

|   |                           |
|---|---------------------------|
| Input-to-Output Isolation Voltage OPI2151   | ± 1500 VDC <sup>(1)</sup> |
| OPI2251   | ± 2500 VDC <sup>(1)</sup> |
| Storage Temperature Range   | -55°C to +150°C           |
| Operating Temperature Range   | -55°C to +150°C           |
| Lead Soldering Temperature (1/16 inch [1.6 mm] from case for 5 sec. with soldering iron) <sup>(2)</sup> | 260°C                     |
| <b>Input Diode</b>  |                           |
| Forward DC Current  | 60 mA                     |
| Peak Forward Current (1 μs pulse width, 300 pps)  | 3.0 A                     |
| Reverse Voltage   | 3.0 V                     |
| Power Dissipation (25°C)  | 100 mW <sup>(3)</sup>     |
| <b>Output Transistor</b>  |                           |
| Power Dissipation   | 150 mW <sup>(4)</sup>     |
| B <sub>1</sub> (B)ICEO  | 30 V                      |
| V <sub>1</sub> (B)ICBO  | 30 V                      |
| V <sub>1</sub> (B)IECO  | 5.0 V                     |

**Notes:** (1) Measured with input diode leads shorted together and output leads shorted together. (2) RMA rosin flux is recommended. Duration can be extended to 10 sec. max. when flow soldering or using a solder pot. (3) Derate linearly 1.33 mW/°C above 25°C. (4) Derate linearly 2.0 mW/°C above 25°C.

**Typical Performance Curves**

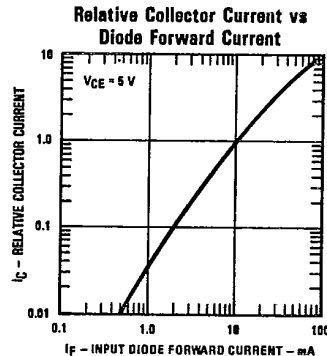
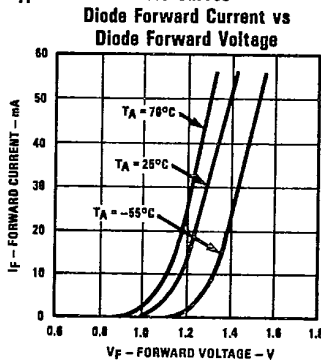

Types OPI2151, OPI2251

T-41-83

Electrical Characteristics (T<sub>A</sub> = 25°C unless otherwise noted)

| Symbol                         | Parameter                               | Min.             | Typ. | Max. | Units      | Test Conditions   |
|--------------------------------|---|------------------|------|------|------------|---|
| <b>Input Diode</b>             |   |                  |      |      |            |   |
| V <sub>F</sub>                 | Forward Voltage                         |                  |      | 1.50 | V          | I <sub>F</sub> = 10.0 mA  |
| V <sub>BR</sub>                | Reverse Breakdown Voltage               | 3.0              |      |      | V          | I <sub>R</sub> = 10.0 μA  |
| I <sub>R</sub>                 | Reverse Current                         |                  |      | 10.0 | μA         | V <sub>R</sub> = 3.0 V  |
| <b>Output Phototransistor</b>  |   |                  |      |      |            |   |
| V <sub>BR</sub> (CEO)          | Collector-to-Emitter Breakdown Voltage  | 30               |      |      | V          | I <sub>C</sub> = 1.0 mA   |
| V <sub>BR</sub> (ECO)          | Emitter-to-Collector Breakdown Voltage  | 5.0              |      |      | V          | I <sub>E</sub> = 100 μA   |
| V <sub>BR</sub> (CBO)          | Collector-Base Breakdown Voltage        | 30               |      |      | V          | I <sub>C</sub> = 100 μA   |
| I <sub>CEO</sub>               | Collector-Emitter Dark Current          |                  | 5.0  | 100  | nA         | V <sub>CE</sub> = 10.0 V  |
| I <sub>CBO</sub>               | Collector-Base Dark Current             |                  |      | 20   | nA         | V <sub>CB</sub> = 10.0 V  |
| C <sub>CE</sub>                | Capacitance Collector-to-Emitter        |                  | 8.0  |      | pF         | V <sub>CE</sub> = 0   |
| h <sub>FE</sub>                | DC Current Gain                         |                  | 150  |      |            | V <sub>CE</sub> = 5.0 V, I <sub>C</sub> = 100 μA                      |
| <b>Coupled</b>                 |   |                  |      |      |            |   |
| I <sub>C</sub> /I <sub>F</sub> | DC Current Transfer Ratio               | 10.0             | 20   |      | %          | I <sub>F</sub> = 10.0 mA, V <sub>CE</sub> = 5.0 V, I <sub>B</sub> = 0 |
| V <sub>CE</sub> (SAT)          | Collector-to-Emitter Saturation Voltage |                  |      | 0.40 | V          | I <sub>F</sub> = 10.0 mA, I <sub>C</sub> = 250 μA, I <sub>B</sub> = 0 |
| V <sub>ISO</sub>               | Isolation Voltage OPI2151<br>OPI2251    | 1500<br>2500     |      |      | VDC<br>VDC | See Note 1  |
| R <sub>IO</sub>                | Input-to-Output Resistance              | 10 <sup>11</sup> |      |      | Ω          | V <sub>IO</sub> = 500 V, See Note 1                                   |
| C <sub>IO</sub>                | Input-to-Output Capacitance             |                  | 2.0  |      | pF         | f = 1.00 MHz, See Note 1  |
| t <sub>r</sub>                 | Output Rise Time                        |                  | 2.0  |      | μs         | V <sub>CC</sub> = 10.0 V, I <sub>C</sub> = 2.0 mA                     |
| t <sub>f</sub>                 | Output Fall Time                        |                  | 2.0  |      | μs         | R <sub>L</sub> = 100Ω, See Test Circuit                               |



Typical Performance Curves

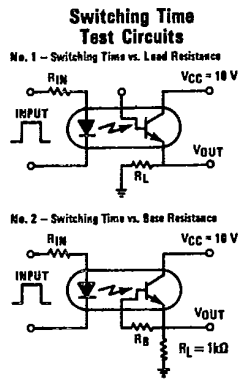
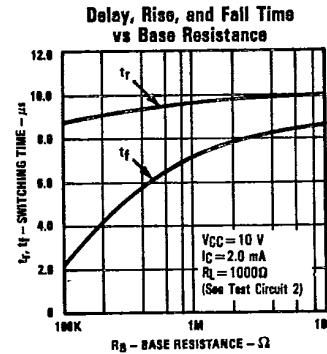
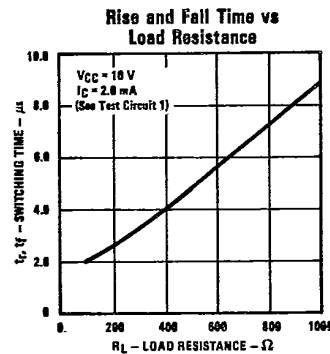
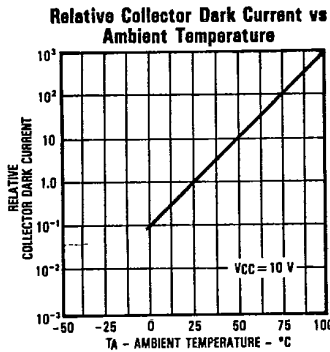
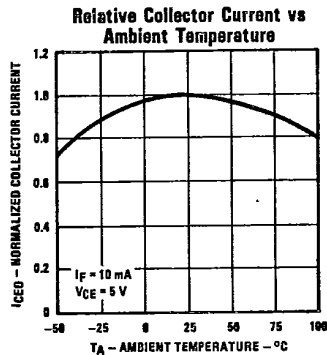
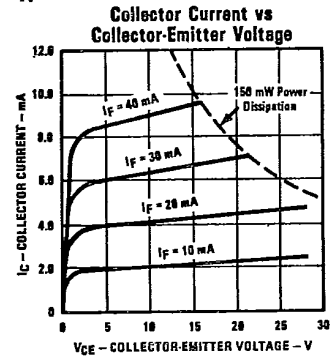

TRW reserves the right to make changes at any time in order to improve design and to supply the best product possible. Plastic color may vary.  
 Optoelectronics Division, TRW Electronic Components Group, 1215 W. Crosby Rd., Carrollton, TX 75006 (214) 323-2200, TLX 6718032 or 215849  
 © TRW Inc. 1985. TRW is the name and mark of TRW Inc. Printed in U.S.A.