

HIGH VOLTAGE RECTIFIER STACKS

Ranges of high voltage rectifier assemblies, incorporating controlled avalanche diodes mounted on fire proof triangular formers. They are supplied with **M6 studs**.

The OSB9410series is intended for application in two phase half wave rectifier circuits. The OSM9410series is intended for application in single phase or three phase bridges or in voltage doubler circuits.

The OSS9410series is intended for all kinds of high voltage rectification.

The OSB9410series and OSM9410series are supplied with a centre tap (8-32UNC). The maximum crest working voltages of the OSB9410 and OSM9410series cover the range from 2 kV to 15 kV, and of the OSS9410series the range from 3 kV to 30 kV, in 1 kV steps.

CIRCUIT OSB9410

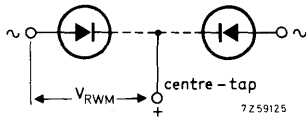

CIRCUIT OSM9410

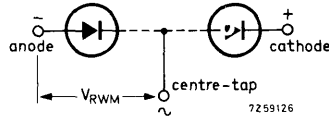

CIRCUIT OSS9410

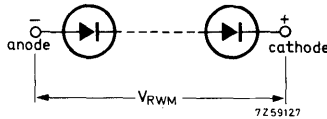

QUICK REFERENCE DATA

Crest working reverse voltage from centre tap to end	OSB9410	-4	-6	...	-28	-30
	OSM9410	-4	-6	...	-28	-30
	V_{RWM}	max.	2	3	14	15 kV
Crest working reverse voltage	OSS9410	-3	-4	...	-29	-30
	V_{RWM}	max.	3	4	29	30 kV

Average forward current with R and L load
(averaged over any 20 ms period)

in free air up to $T_{amb} = 35^{\circ}\text{C}$

$I_{F(AV)}$ max. 10 A

in oil up to $T_{oil} = 35^{\circ}\text{C}$

$I_{F(AV)}$ max. 30 A

Non-repetitive peak forward current

$t = 10$ ms; half sine wave; $T_j = 175^{\circ}\text{C}$ prior to surge

I_{FSM} max. 800 A

All information applies to frequencies up to 400 Hz

RATINGS Limiting values in accordance with the Absolute Maximum System (IEC 134)

<u>Voltages</u>		OSB9410	-4	-6	...	-28	-30
		OSM9410	-4	-6	...	-28	-30
Crest working reverse voltage	V_{RWM}	max.	2	3	...	14	15 kV
<u>Currents</u>		OSS9410	-3	-4	...	-29	-30
Crest working reverse voltage	V_{RWM}	max.	3	4	...	29	30 kV

Currents

Average forward current (averaged over any 20 ms period)

in free air up to $T_{amb} = 35\text{ }^{\circ}\text{C}$

$I_{F(AV)}$ max. 10 A

in oil up to $T_{oil} = 35\text{ }^{\circ}\text{C}$

$I_{F(AV)}$ max. 30 A

Repetitive peak forward current

I_{FRM} max. 450 A

Non-repetitive peak forward current

$t = 10\text{ ms}$; half sine wave; $T_j = 175\text{ }^{\circ}\text{C}$ prior to surge

I_{FSM} max. 800 A

Reverse power dissipation

		OSB9410	-4	-6	...	-28	-30
		OSM9410	-4	-6	...	-28	-30
Repetitive peak reverse power dissipation	P_{RRM}	max.	9	13.5	...	63	67.5 kW
$t = 10\text{ }\mu\text{s}$ (square wave; $f = 50\text{ Hz}$)							
$T_j = 175\text{ }^{\circ}\text{C}$							
Non-repetitive peak reverse power dissipation	P_{RSM}	max.	55	80	...	375	400 kW
$T_j = 25\text{ }^{\circ}\text{C}$ prior to surge							
	P_{RSM}	max.	8.5	13	...	60.5	65 kW
$T_j = 175\text{ }^{\circ}\text{C}$ prior to surge							
<u>Reverse power dissipation</u>		OSS9410	-3	-4	...	-29	-30
Repetitive peak reverse power dissipation	P_{RRM}	max.	13.5	18	...	130.5	135 kW
$t = 10\text{ }\mu\text{s}$ (square wave; $f = 50\text{ Hz}$)							
$T_j = 175\text{ }^{\circ}\text{C}$							
Non-repetitive peak reverse power dissipation	P_{RSM}	max.	80	105	...	775	800 kW
$T_j = 25\text{ }^{\circ}\text{C}$ prior to surge							
	P_{RSM}	max.	13	17	...	126	130 kW
$T_j = 175\text{ }^{\circ}\text{C}$ prior to surge							

Temperatures

Storage temperature	T_{stg}	- 55 to + 175	$^{\circ}\text{C}$
Junction temperature	T_j	max. 175	$^{\circ}\text{C}$

CHARACTERISTICS (See note 1)

		OSB9410 -4	-6	...	-28	-30
		OSM9410 -4	-6	...	-28	-30
<u>Forward voltage</u>						
$I_F = 150 \text{ A}; T_j = 25 \text{ }^\circ\text{C}$	V_F	< 3.6	5.4	...	25.2	27 V
<u>Reverse avalanche breakdown voltage</u> ¹⁾						
$I_R = 5 \text{ mA}; T_j = 25 \text{ }^\circ\text{C}$	$V_{(BR)R}$	> 2.5	3.75	...	17.5	18.75 kV
		< 4	6	...	28	30 kV

		OSS9410 -3	-4	...	-29	-30
<u>Forward voltage</u>						
$I_F = 150 \text{ A}; T_j = 25 \text{ }^\circ\text{C}$	V_F	< 5.4	7.2	...	52.2	54 V
<u>Reverse avalanche breakdown voltage</u> ¹⁾						
$I_R = 5 \text{ mA}; T_j = 25 \text{ }^\circ\text{C}$	$V_{(BR)R}$	> 3.75	5	...	36.25	37.5 kV
		< 6	8	...	58	60 kV

Reverse current

$V_{RM} = V_{RWMmax}; T_j = 125 \text{ }^\circ\text{C}$

$I_{RM} < 1.6 \text{ mA}$

NOTES

1. The Ratings and Characteristics given apply from centre tap to end. (Not for OSS9410series).
2. Type number suffix
 The suffix consists of a figure indicating the total number of diodes, followed by a letter indicating the base.
 A = M6 studs at the ends.
3. Operating position
 The rectifier units can be operated at their maximum ratings when mounted in any position.

¹⁾ The breakdown voltage increases, by approximately 0.1% per °C with increasing junction temperature.

MECHANICAL DATA

Dimensions in mm

n = total number of diodes.

OSS9410-nA

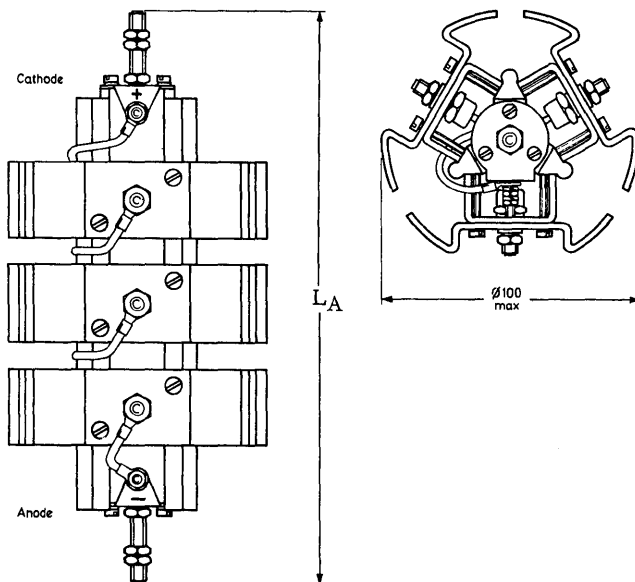

The drawing shows the OSS9410series.

The OSB9410 and OSM9410series differ in the following respects:

OSB9410 series - has a centre tap marked +; anode and cathode terminals are both marked ~.

OSM9410series - has a centre tap marked ~.

Table of lengths and weights (mm and g)

number of diodes	n	3	4 to 6	7 to 9	10 to 12	13 to 15
maximum lengths	L_A	143	184	224	264	305
weights	W_A	215	413	611	809	1007

number of diodes	n	16 to 18	19 to 21	22 to 24	25 to 27	28 to 30
maximum lengths	L_A	345	385	426	466	506
weights	W_A	1208	1406	1604	1802	2000

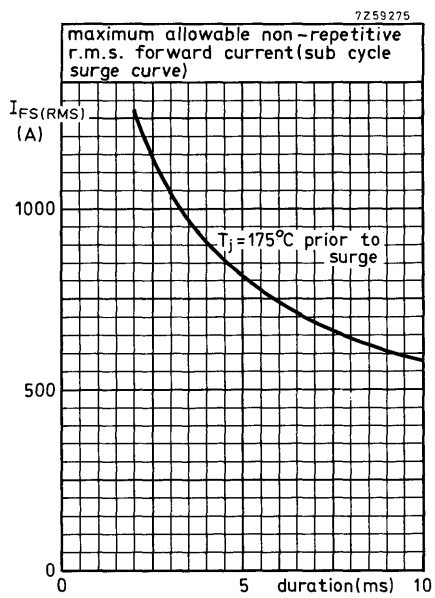
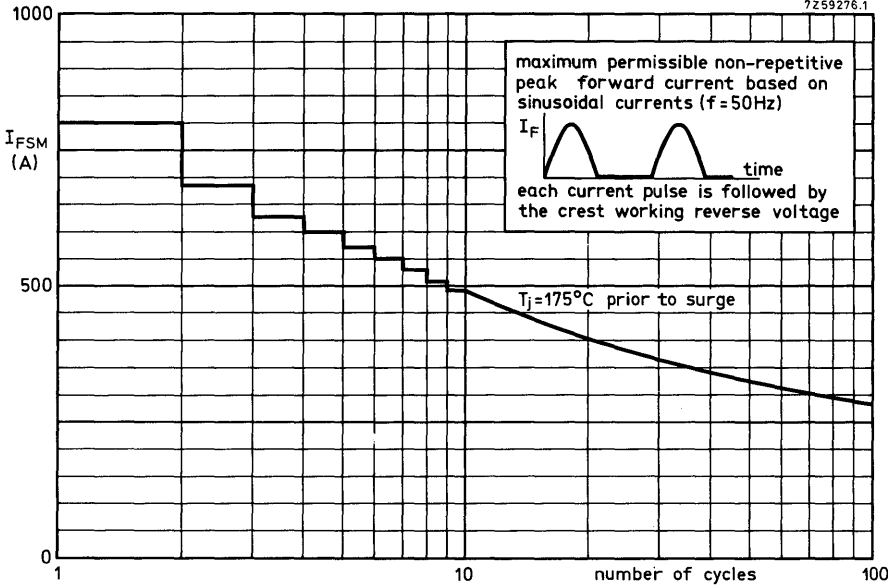

7259272

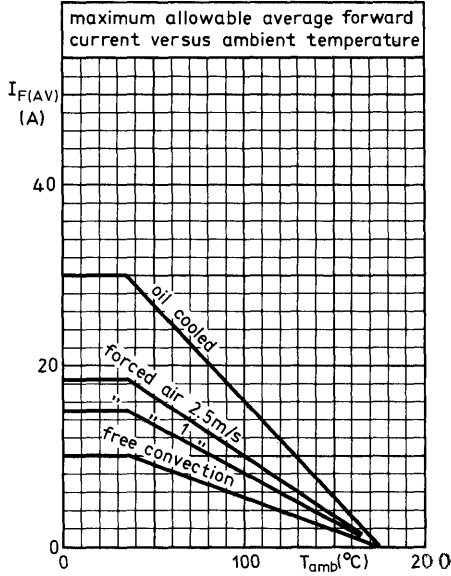

7259273

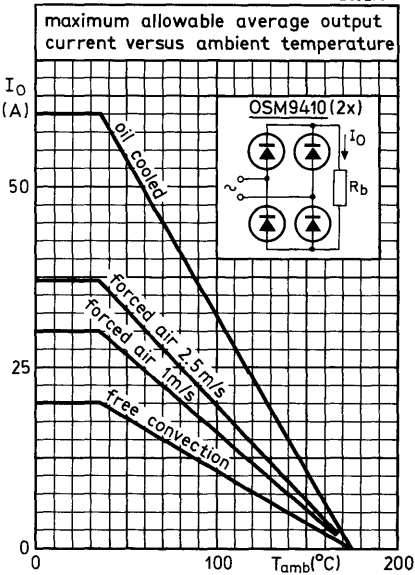

7259274

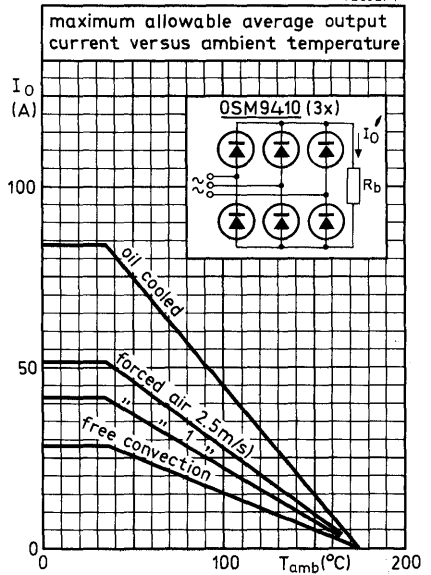

APPLICATION INFORMATION

OSB9410series

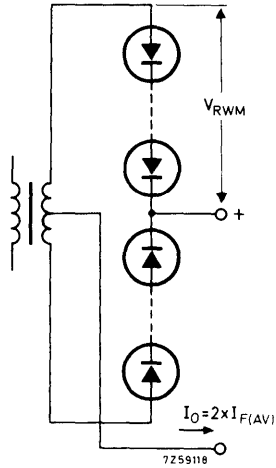

OSM9410series

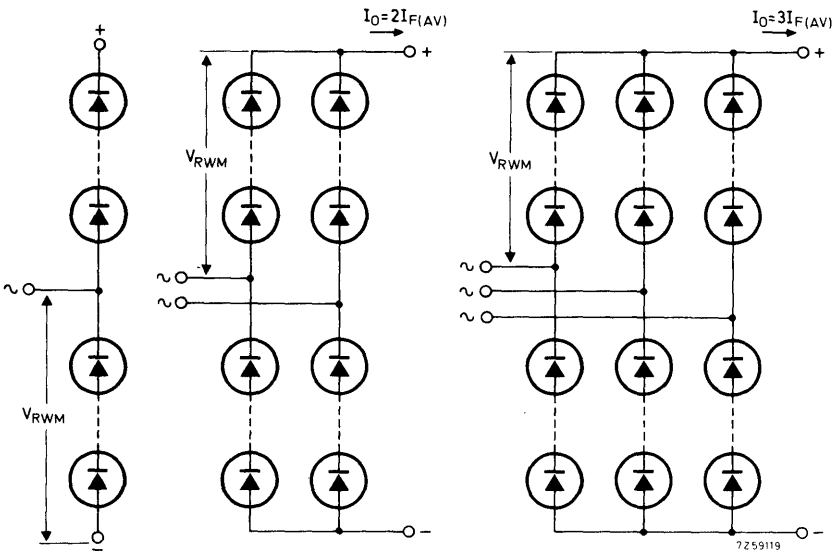

voltage doubler
1x OSM9410

rectifier circuits with respectively
2x OSM9410 and 3x OSM9410