

Features

High Luminous LEDs
 5.0x4.1mm Standard Directivity
 Superior Weather-resistance
 UV Resistant Epoxy
 Water Clear Type

Applications

Electronic Signs And Signals
 Small Area Illuminations
 Back Lighting
 Other Lighting

Outline Dimension

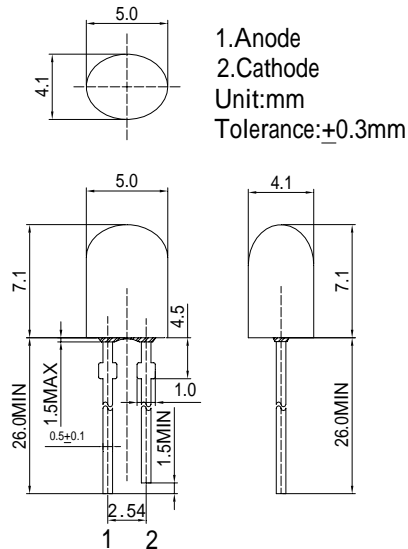

Absolute Maximum Rating

($T_a=25$)

Item	Symbol	Value	Unit
DC Forward Current	I_F	30	mA
Pulse Forward Current*	I_{FP}	100	mA
Reverse Voltage	V_R	5	V
Power Dissipation	P_D	78	mW
Operating Temperature	T_{opr}	-30 ~ +85	
Storage Temperature	T_{stg}	-40 ~ +100	
Lead Soldering Temperature	T_{sol}	260 /5sec	-

*Pulse width Max.10ms Duty ratio max 1/10

Directivity

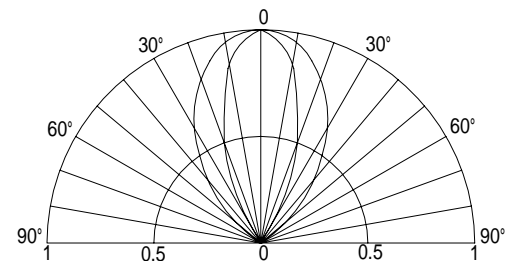

Electrical -Optical Characteristics

($T_a=25$)

Item	Symbol	Condition	Min.	Typ.	Max.	Unit
DC Forward Voltage	V_F	$I_F=20$ mA	1.8	2.1	2.6	V
DC Reverse Current	I_R	$V_R=5$ V	-	-	10	μ A
Domi. Wavelength*	λ_D	$I_F=20$ mA	620	625	630	nm
Luminous Intensity*	I_v	$I_F=20$ mA	2180	3000	-	mcd
50% Power Angle	$2\theta_{1/2}$	$I_F=20$ mA	-	70/40	-	deg

*1 Tolerance of dominant wavelength is ± 1 nm

*2 Tolerance of luminous intensity is $\pm 15\%$