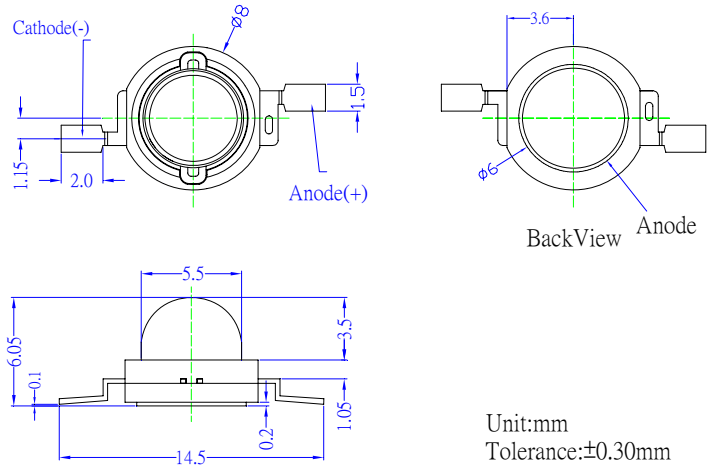

**■Features**

- Highest luminous flux
- Super energy efficiency
- Long Lifetime Operation
- Superior ESD protection
- Superior UV Resistance

**■Applications**

- Read lights (car, bus, aircraft)
- Portable (flashlight, bicycle)
- Bollards / Security / Garden
- Traffic signaling / Beacons
- In door / Out door Commercial lights
- Automotive Ext

**■Outline Dimension**

**■Absolute Maximum Rating**

(Ta=25°C)

Item	Symbol	Value	Unit
DC Forward Current	$I_F$	400	mA
Pulse Forward Current*	$I_{FP}$	500	mA
Reverse Voltage	$V_R$	5	V
Power Dissipation	$P_D$	1200	mW
Operating Temperature	$T_{opr}$	-30 ~ +85	°C
Storage Temperature	$T_{stg}$	-40 ~ +100	°C
Lead Soldering Temperature	$T_{sol}$	260°C/5sec	-

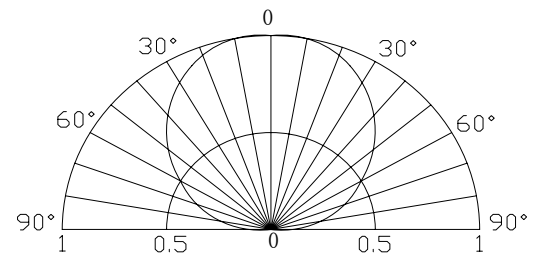
\*Pulse width Max.10ms Duty ratio max 1/10

**■Directivity**

**■Electrical -Optical Characteristics**

(Ta=25°C)

Item	Symbol	Condition	Min.	Typ.	Max.	Unit
DC Forward Voltage	$V_F$	$I_F=350mA$	2.0	2.5	3.0	V
DC Reverse Current	$I_R$	$V_R=5V$	-	-	10	μA
Domi. Wavelength	$\lambda_D$	$I_F=350mA$	620	625	630	nm
Luminous Flux	$\Phi_v$	$I_F=350mA$	40	50	-	lm
50% Power Angle	$2\theta_{1/2}$	$I_F=350mA$	-	120	-	deg

Note: Don't drive at rated current more than 5s without heat sink for Xeon 1 emitter series.

**■Forward Operating Current (DC)**
