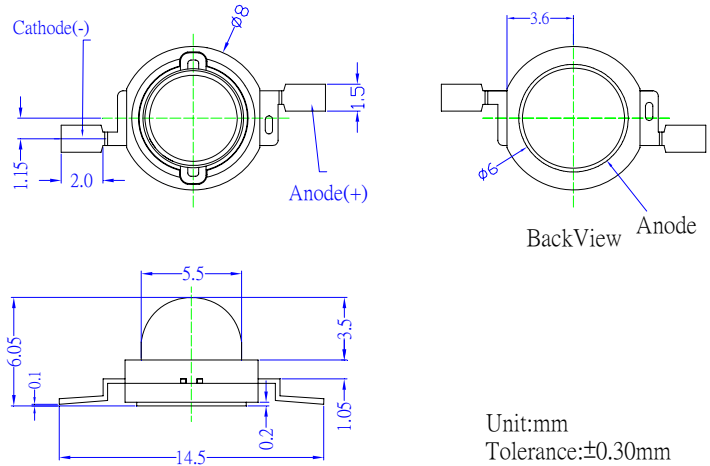

■Features

- Highest luminous flux
- Super energy efficiency
- Long Lifetime Operation
- Superior ESD protection
- Superior UV Resistance

■Applications

- Read lights (car, bus, aircraft)
- Portable (flashlight, bicycle)
- Bollards / Security / Garden
- Traffic signaling / Beacons
- In door / Out door Commercial lights
- Automotive Ext

■Outline Dimension

■Absolute Maximum Rating

(Ta=25°C)

Item	Symbol	Value	Unit
DC Forward Current	I _F	200	mA
Pulse Forward Current*	I _{FP}	250	mA
Reverse Voltage	V _R	5	V
Power Dissipation	P _D	600	mW
Operating Temperature	T _{opr}	-30 ~ +85	°C
Storage Temperature	T _{stg}	-40 ~ +100	°C
Lead Soldering Temperature	T _{sol}	260°C/5sec	-

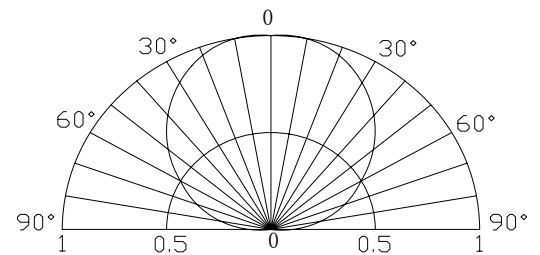
*Pulse width Max.10ms Duty ratio max 1/10

■Directivity

■Electrical -Optical Characteristics

(Ta=25°C)

Item	Symbol	Condition	Min.	Typ.	Max.	Unit
DC Forward Voltage	V _F	I _F =150mA	2.0	2.5	3.0	V
DC Reverse Current	I _R	V _R =5V	-	-	10	μA
Domi. Wavelength	λ _D	I _F =150mA	585	590	595	nm
Luminous Flux	Φ _v	I _F =150mA	15	20	-	lm
50% Power Angle	2θ _{1/2}	I _F =150mA	-	120	-	deg

Note: Don't drive at rated current more than 5s without heat sink for Xeon H emitter series.

■Forward Operating Current (DC)
