



## OTD9120A

---

**1200/1152/1080/960ch output Gate driver**

***Preliminary***

DEC. 19, 2011

Version 0.8

## Table of Contents

	<u>PAGE</u>
<b>1. GENERAL DESCRIPTION</b> .....	<b>3</b>
<b>2. FEATURES</b> .....	<b>3</b>
<b>3. ORDERING INFORMATION</b> .....	<b>3</b>
<b>4. BLOCK DIAGRAM</b> .....	<b>4</b>
<b>5. SIGNAL DESCRIPTIONS</b> .....	<b>5</b>
5.1. OUTPUT SEQUENCE & FRAME CONTROL .....	6
5.2. PIN ASSIGNMENT .....	8
<b>6. FUNCTIONAL DESCRIPTIONS</b> .....	<b>9</b>
6.1. DEVICE OPERATION .....	9
<b>7. START PULSE INPUT LIMITATION</b> .....	<b>10</b>
7.1. DEVICE POWER SUPPLY .....	11
7.2. POWER ON/OFF SEQUENCE .....	11
<b>8. ELECTRICAL SPECIFICATIONS</b> .....	<b>12</b>
8.1. ABSOLUTE MAXIMUM RATINGS .....	12
8.2. RECOMMENDED OPERATING CONDITIONS (OPTION) .....	12
8.3. ELECTRICAL CHARACTERISTICS .....	12
8.4. AC CHARACTERISTICS .....	13
8.5. TIMING WAVEFORMS .....	13
<b>9. CHIP INFORMATION</b> .....	<b>14</b>
9.1. PAD ASSIGNMENT .....	14
9.2. PAD DIMENSION .....	14
9.3. PAD LOCATIONS .....	15
9.4. ALIGNMENT MARK .....	24
<b>10. DISCLAIMER</b> .....	<b>25</b>
<b>11. REVISION HISTORY</b> .....	<b>26</b>

## 1200/1152/1080/960ch output Gate driver

### 1. GENERAL DESCRIPTION

The OTD9120A is a 1200/1152/1080/960-channel outputs gate driver, which is used for driving the gate line of TFT LCD panel. It is designed for 2-level output with 40V LCD driving voltage range.

### 2. FEATURES

- 2-level output
- 1200/1152/1080/960 channel outputs selectable with 2 dummy outputs
- Maximum 200KHz operation frequency
- Digital supply voltage: 2.3V to 3.6V
- LCD driving voltage range: 40V
- Bi-directional data shift capability
- High voltage CMOS process technology
- COG/COF package

### 3. ORDERING INFORMATION

Product Number	Package Type
OTD9120A-C	Chip Form with Gold Bump (thickness 400um)
OTD9120A-C1	Chip Form with Gold Bump (thickness 300um)
OTD9120A-C2	Chip Form with Gold Bump (thickness 250um)
OTD9120A-C3	Chip Form with Gold Bump (thickness 300um)

4. BLOCK DIAGRAM

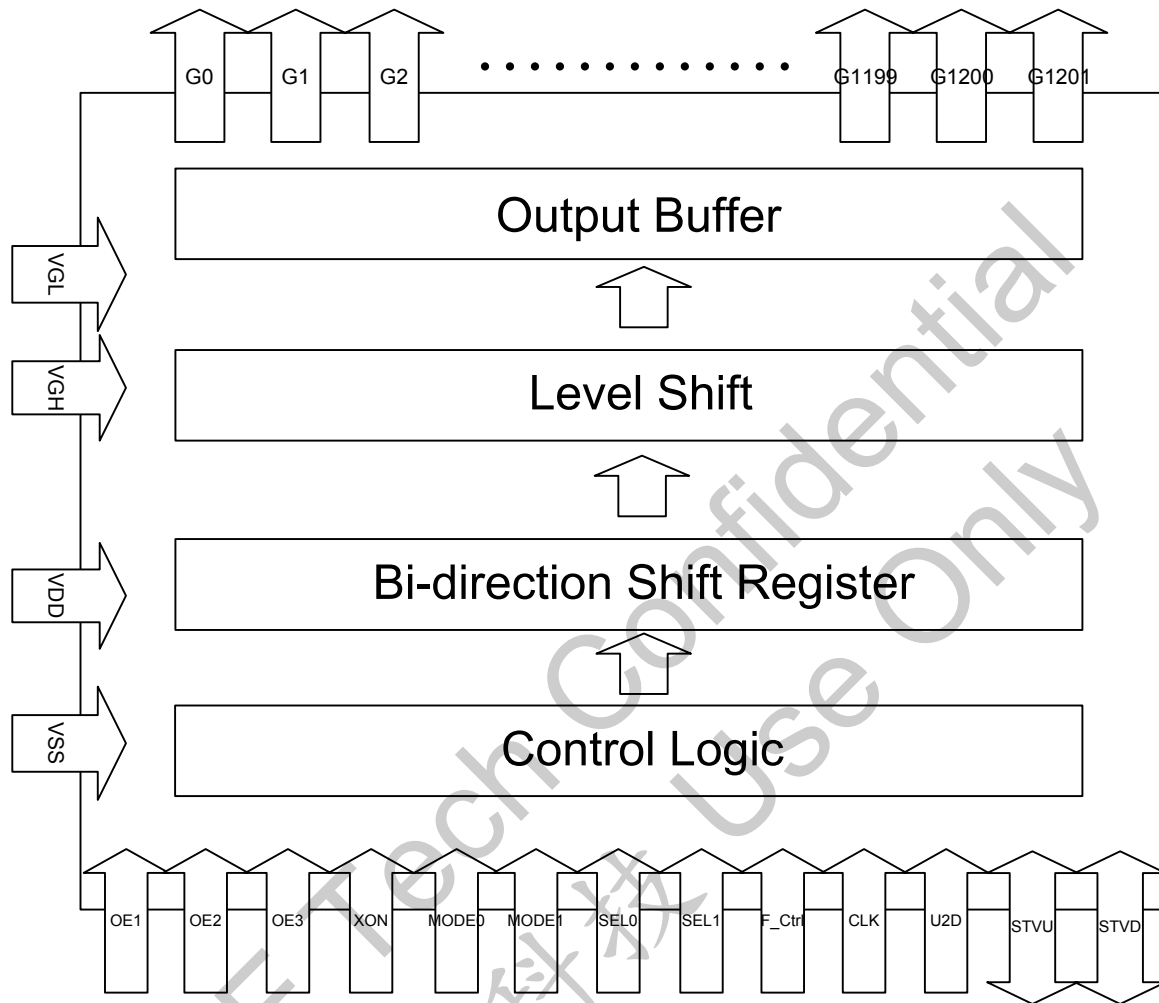

Note: (1) G0 and G1201 are LCD panel auxiliary pins, these pins always output VGL level.

**5. SIGNAL DESCRIPTIONS**

Designation	I/O	Function	Description																				
CLK	In	Shift clock input	The clock for the internal shift registers.																				
UD	In	Shift direction control pin	The shift direction of device internal shift register is controlled by this pin as shown below: UD=H, STVD→OUT1→OUT2→...→OUT1200→STVU UD=L, STVU→OUT1200→...→OUT2→OUT1→STVD																				
STVD STVU	In/ Out	Start pulse input/output pin	UD=H, STVD is used for start pulse input STVU is used for start pulse output UD=L, STVU is used for start pulse input STVD is used for start pulse output																				
OE1 OE2 OE3	In	Output enable control	The OE1 signal controls the OUT1,OUT4,OUT7,...,OUT1195,OUT1198output enable. The OE2 signal controls the OUT2,OUT5,OUT8,...,OUT1196,OUT1199output enable. The OE3 signal controls the OUT3,OUT6,OUT9,...,OUT1197,OUT1200output enable. OE1,2,3=H: outputs are fixed to VGL regardless of CPV. However, the content of shift register is not cleared. OE1,2,3=L: Normal operation																				
/XON	In	Output all-on control	When /XON is set to L, all outputs are fixed to VGH. Note that this pin has higher priority than OE. However, the content of shift register is not cleared. /XON is pulled high to VDD internally. When it is not used, connecting to VDD is recommended.																				
MODE0 MODE1	In	Channel mode selection	Channel mode selection <table border="1"> <thead> <tr> <th>Output Channel</th> <th>Disable channel</th> <th>MODE1</th> <th>MODE0</th> </tr> </thead> <tbody> <tr> <td>1200</td> <td>-</td> <td>H</td> <td>H</td> </tr> <tr> <td>1152</td> <td>OUT577-OUT624</td> <td>H</td> <td>L</td> </tr> <tr> <td>1080</td> <td>OUT541-OUT660</td> <td>L</td> <td>H</td> </tr> <tr> <td>960</td> <td>OUT481-OUT720</td> <td>L</td> <td>L</td> </tr> </tbody> </table>	Output Channel	Disable channel	MODE1	MODE0	1200	-	H	H	1152	OUT577-OUT624	H	L	1080	OUT541-OUT660	L	H	960	OUT481-OUT720	L	L
Output Channel	Disable channel	MODE1	MODE0																				
1200	-	H	H																				
1152	OUT577-OUT624	H	L																				
1080	OUT541-OUT660	L	H																				
960	OUT481-OUT720	L	L																				
SEL0 SEL1	In	Output sequence control	Output sequence control This pin controls the driver output sequence. Normally pull low . <table border="1"> <thead> <tr> <th>Scan type</th> <th>SEL1</th> <th>SEL0</th> </tr> </thead> <tbody> <tr> <td>Z+弓</td> <td>H</td> <td>H</td> </tr> <tr> <td>弓</td> <td>L</td> <td>H</td> </tr> <tr> <td>Z</td> <td>L</td> <td>L</td> </tr> </tbody> </table> <p>Note: When SEL1=H and SEL0=L, the output sequence control can not be supported</p>	Scan type	SEL1	SEL0	Z+弓	H	H	弓	L	H	Z	L	L								
Scan type	SEL1	SEL0																					
Z+弓	H	H																					
弓	L	H																					
Z	L	L																					
OUT1~ OUT1200	Out	Driver output	The output is either VGH or VGL for driving the gate line of TFT LCD panel.																				
F_CTRL	In	Frame control	Half source driver This pin decides to inverse the output sequence or not in odd or even frame																				
OUT0, OUT1201	Out	Auxiliary pins	These two pins always output VGL level.																				
PASS	-	Internal pass	The pins are shorted internally. (Refer to section 9.4)																				
VDD	In	Power supply	Digital power supply																				
VSS	In	Power supply	Grounding for VDD																				
VGH	In	Power supply	Power supply for Gate on output.																				
VGL	In	Power supply	Power supply for Gate off output.																				

**5.1. Output Sequence & Frame Control**
**U\_D=H**

SEL0	SEL1	F_CTRL	Scan type	Output sequence
H	H	L	Z+弓	1→2→3→4→6→5→8→7→.....
		H		2→1→4→3→5→6→7→8→.....
H	L	L	弓	1→2→4→3→5→6→8→7→.....
		H		2→1→3→4→6→5→7→8→.....
L	L	L	Z	1→2→3→4→5→6→7→8→.....
		H		2→1→4→3→6→5→8→7→.....

**U\_D=L**

SEL0	SEL1	F_CTRL	Scan type	Output sequence
H	H	L	Z+弓	.....8→7→6→5→3→4→1→2
		H		.....7→8→5→6→4→3→2→1
H	L	L	弓	.....8→7→5→6→4→3→1→2
		H		.....7→8→6→5→3→4→2→1
L	L	L	Z	.....8→7→6→5→4→3→2→1
		H		.....7→8→5→6→3→4→1→2

ORISE Tech Confidential  
For 卓領科技 Use Only

FRP=LOW

FRP=HIGH

Z

弓

Z

+

弓

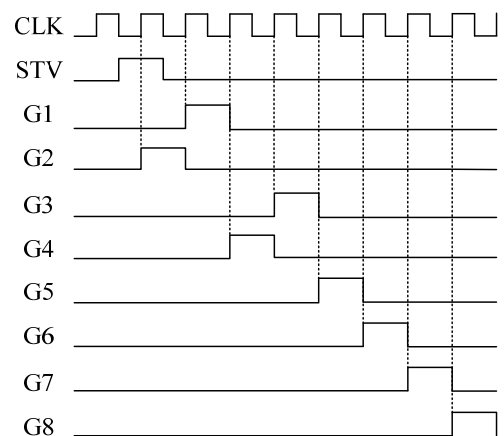
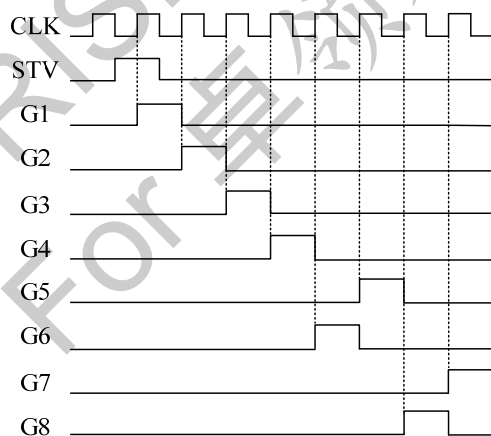
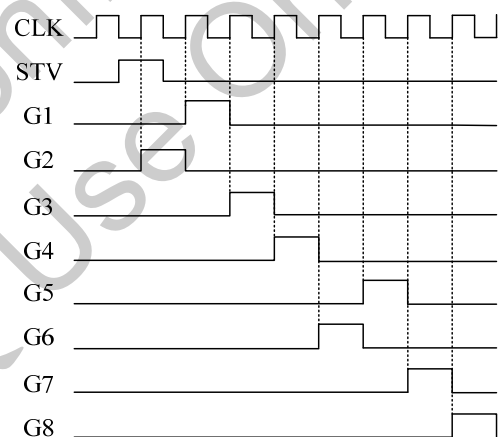
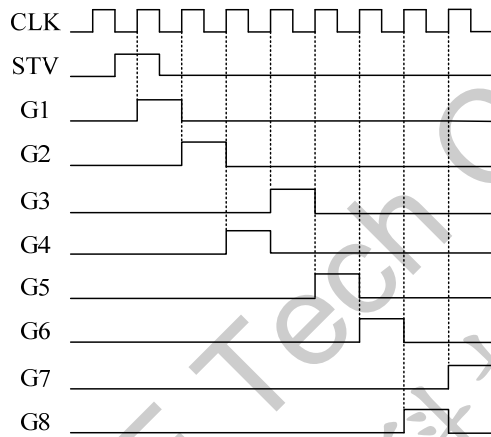
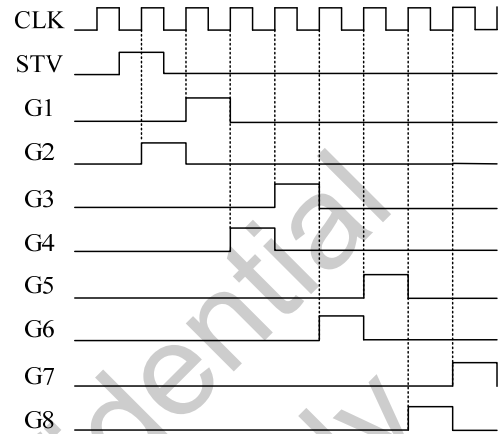
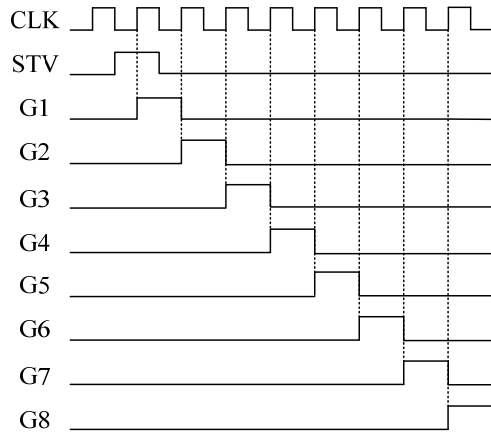

5.2. Pin Assignment

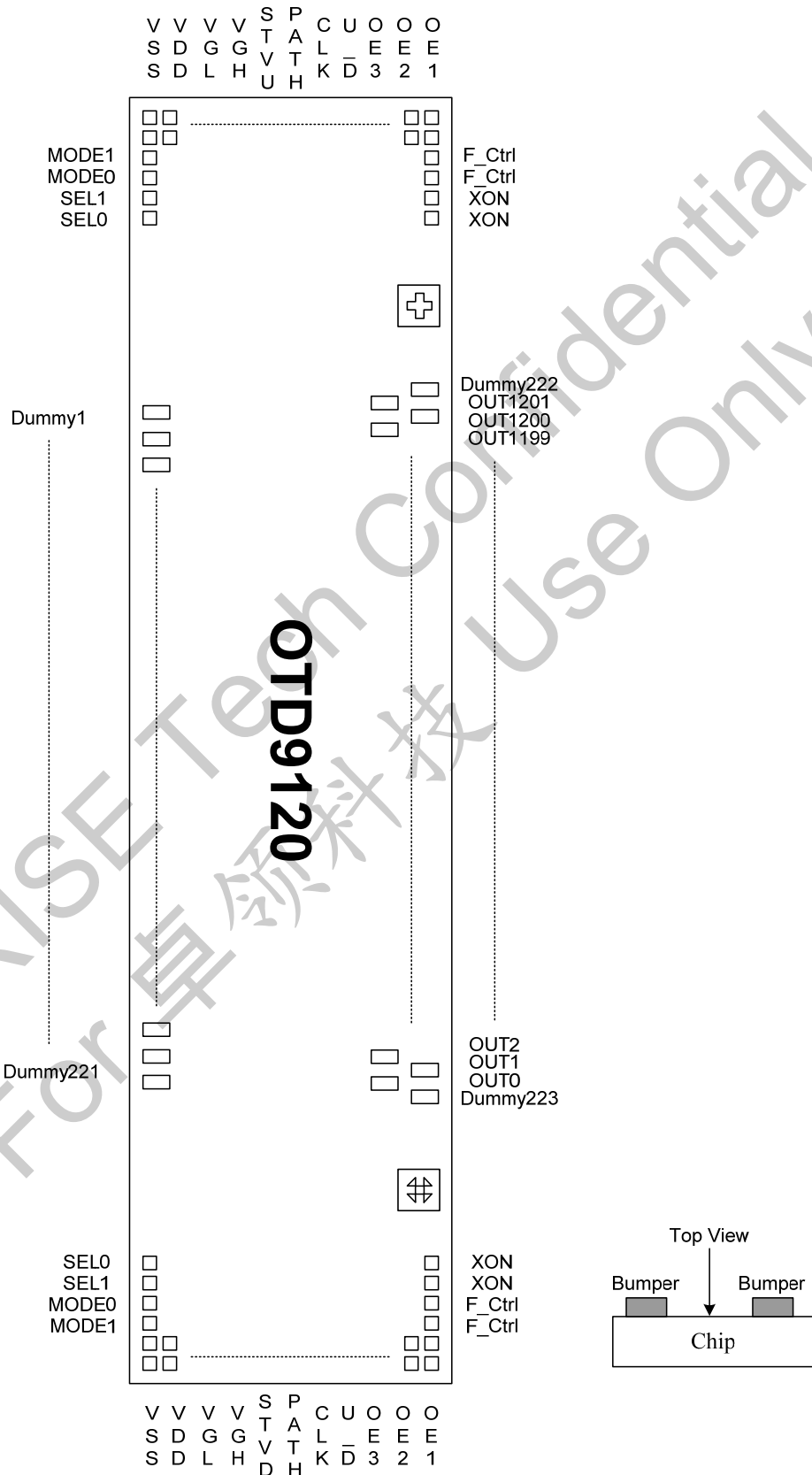



## 6. FUNCTIONAL DESCRIPTIONS

### 6.1. Device Operation

When UD=H, MODE2=H & MODE1=H, the STVD start pulse input is sensed on the rising edge of CPV and stored in the first stage of shift register, which makes the first scan signal output from the OUT1 pin. While stored data is transferred to the next stage shift register on the rising edge of next CPV, new data of STVD is sensed and stored simultaneously.

The output pin (OUT1 to OUT1200) supplies VGH voltage or VGL voltage to the LCD panel depending on the data stored in the shift register. For normal operation, a VGH voltage is outputted one by one from OUT1 to OUT1200 in synchronization with CPV pulse.

After 1200 CPV rising edge are past, the STVU goes up to high level at the 1200th falling edge of CPV and goes down to low level at the 401st falling edge of CPV. This STVU output signal becomes the STVD start pulse input of next cascaded gate driver.

When OE=H, the corresponding output channels are fixed to VGL level regardless of CPV. The channel output returns to normal status as soon as OE goes back to L.

Example of input/output timing (UD=H, MODE2=H & MODE1=H with OE & /XON)

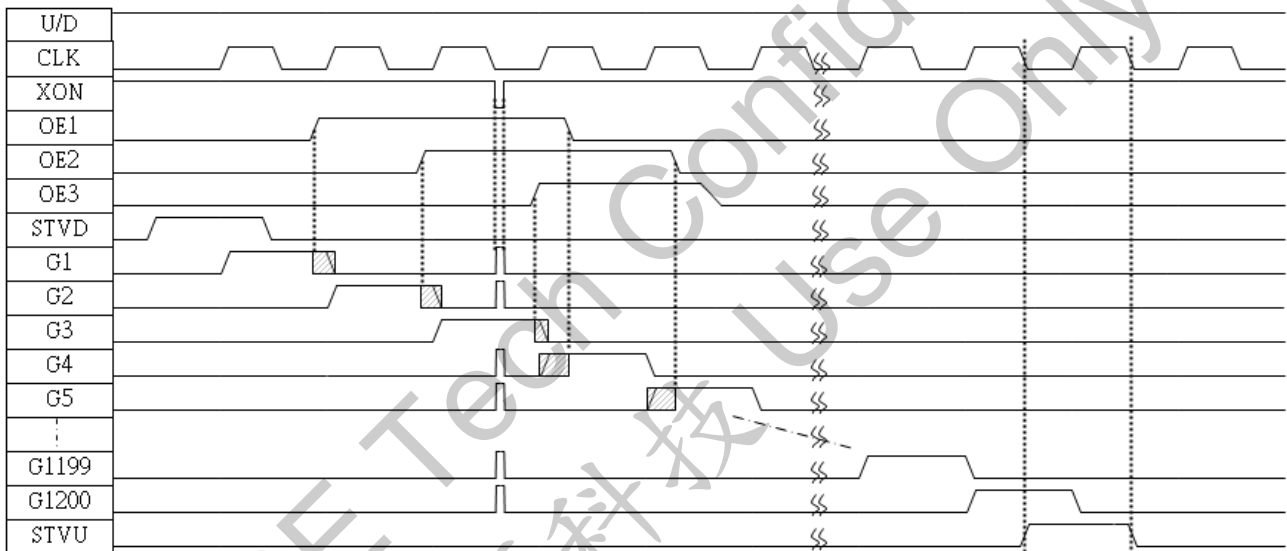

Example of input/output timing (UD=L, MODE2=H & MODE1=H with OE & /XON)

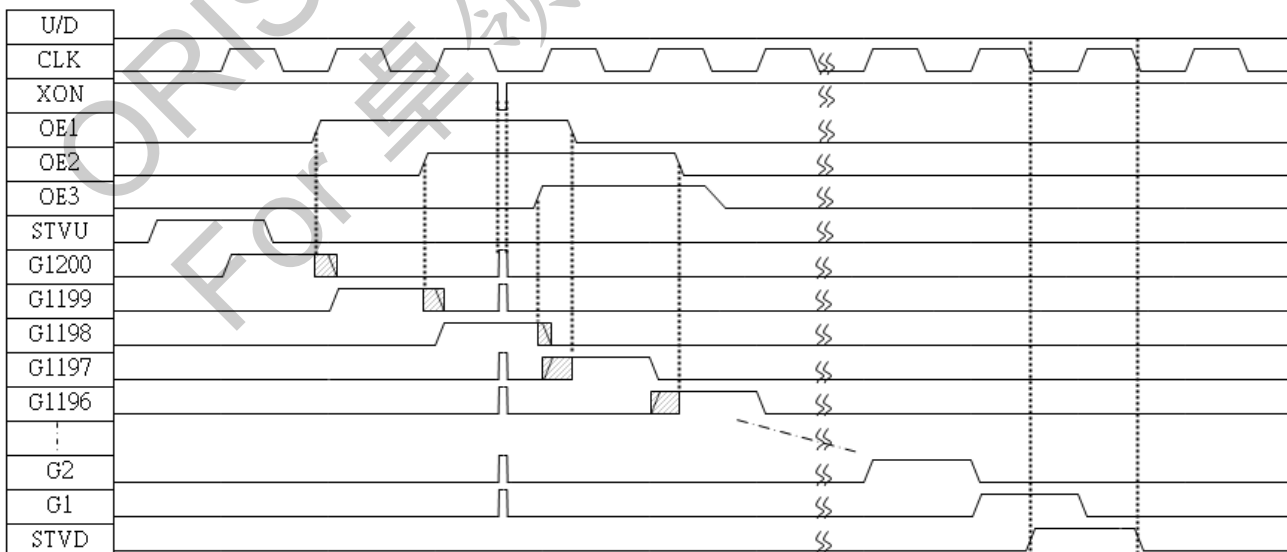

## 7. START PULSE INPUT LIMITATION

The available start pulse is in the following diagram.

### ■Signal Start Pulse Input

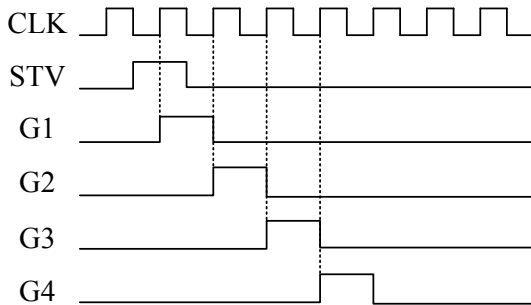

### ■Long Start Pulse Input (2 CLK Period)

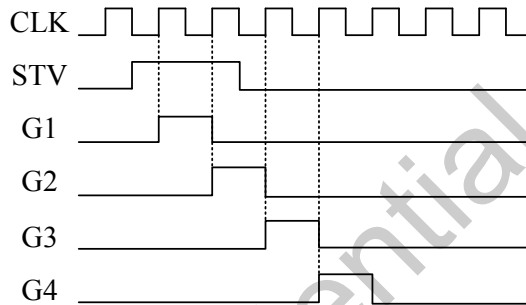

### ■Dual Start Pulse Input

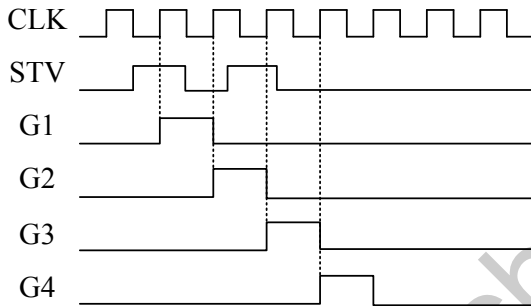

### ■Long Start Pulse Input (More Than 2 CLK Period)

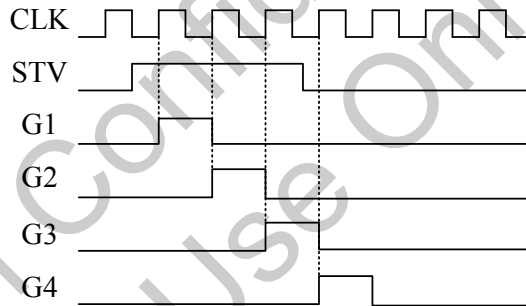

Note4: However the start pulse form changes, gate output keeps output sequentially.

### 7.1. Device Power Supply

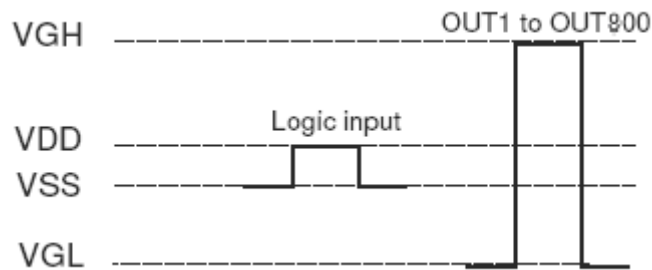

The logic levels of CPV, UD, OE, /XON, MODE1, MODE2, STVD and STVU have to swing between VDD for "H" and VSS for "L".

### 7.2. Power on/off Sequence

To prevent the device from damage due to latch up, the power ON/OFF sequence shown below must be followed.

When power on: VDD→VGL→VGH

When power off: VGH→VGL→VDD

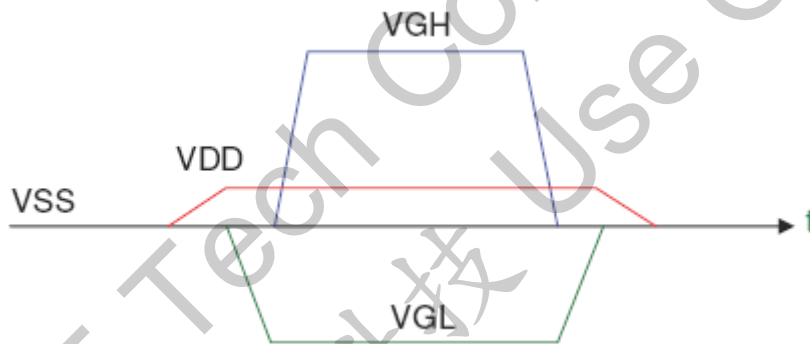

## 8. ELECTRICAL SPECIFICATIONS

### 8.1. Absolute Maximum Ratings

Parameter	Symbol	Rating			Unit	Note
		Min.	Typ.	Max.		
Power Supply Voltage 1	VGH	-0.3	-	+42	V	
Power Supply Voltage 2	VDD	-0.3	-	+7	V	
Power Supply Voltage 3	VGL	VGH-42	-	+0.3	V	
Input Voltage	V <sub>IN</sub>	-0.3	-	VDD+0.3	V	
Operating Temperature	T <sub>A</sub>	-40	-	+85	°C	
Storage Temperature	T <sub>STG</sub>	-55	-	+125	°C	

Note1 : The maximum applicable voltage on any pin with respect to 0V.

Note2 : Device is subject to be damaged permanently if stresses beyond those absolute maximum ratings listed above.

### 8.2. Recommended Operating Conditions (option)

Parameter	Symbol	Rating			Unit	Note
		Min.	Typ.	Max.		
Power supply voltage 1	VGH	10	-	35	V	
Power supply voltage 2	VDD	2.3	3.3	3.6	V	
Power supply voltage 3	VGL	-20	-	-5	V	
Power supply voltage 4	VGH -VGL	15	-	40	V	
Power supply voltage 5	VDD-VGL	6	-	-	V	
Operation frequency	F <sub>CPV</sub>	-	-	200	KHz	

### 8.3. Electrical Characteristics

Parameter	Symbol	Applicable pin	Condition	Rating			Unit	Note
				Min.	Typ.	Max.		
Input H voltage	V <sub>IH</sub>	All input	-	0.7VDD	-	VDD	V	
Input L voltage	V <sub>IL</sub>	All input	-	VSS	-	0.3VDD		
Output H voltage	V <sub>OH</sub>	STVD,2	I <sub>OH</sub> =40μA	VDD-0.4	-	VDD		
Output L voltage	V <sub>OL</sub>	STVD,2	I <sub>OL</sub> =40μA	VSS	-	VSS+0.4		
Output H resistance	R <sub>OH</sub>	OUT1 ~ OUT1200	V <sub>OUT</sub> = VGH-0.5V	-	-	1000	Ω	
Output L resistance	R <sub>OL</sub>	OUT1 ~ OUT1200	V <sub>OUT</sub> = VGL+0.5V	-	-	1000	Ω	
Input leakage current	I <sub>IN</sub>	Note(2)	-	-	-	±1	μA	
Pull high resistance	R <sub>PU</sub>	/XON	-	50	-	330	kΩ	
VDD Power consumption	I <sub>VDD</sub>	VDD	Note(1)	-	15	100	μA	
VGH Power consumption	I <sub>VGH</sub>	VGH		-	50	250	μA	
VGL Power consumption	I <sub>VGL</sub>	VGL		-	-50	-250	μA	

Note: (1) Power consumption in the following condition:

Output no load, VGH=25V, VGL=-8V, VDD=3.3V, V<sub>IH</sub>=VDD, V<sub>IL</sub>=VSS, F<sub>CPV</sub>=50KHz, OE=V<sub>IL</sub>, /XON=V<sub>IH</sub>

(2) All input except /XON

**8.4. AC Characteristics**

Parameter	Symbol	Condition	Rating			Unit	Note
			Min.	Typ.	Max.		
CLK period	$T_{CLK}$	-	5	-	-	μs	
CLK pulse width	$PW_{CLK}$	50% duty cycle	2.5	-	-		
Clock Rising Time	$Tr_{ck}$				0.1		
Clock Falling Time	$Tf_{ck}$				0.1		
OE pulse width	$Tw_{cl}$	-	1	-	-		
XON pulse width	$Tw_{xon}$	-	10	-	-		
Data setup time	$Tsu$	-	0.7	-	-		
Data hold time	$Thd$	-	0.7	-	-		
CLK to output delay time	$Tdo$	CL=300pF	-	-	1.2		
Start pulse output delay time	$Tdt$	Loading=30pF	-	-	1		
OE to output delay time	$Toe$	CL=300pF	-	-	1		
XON to output delay time	$Txon$	CL=300pF	-	-	30		

Note: The measurement point for all of above signals is at 50% of input/output amplitude.

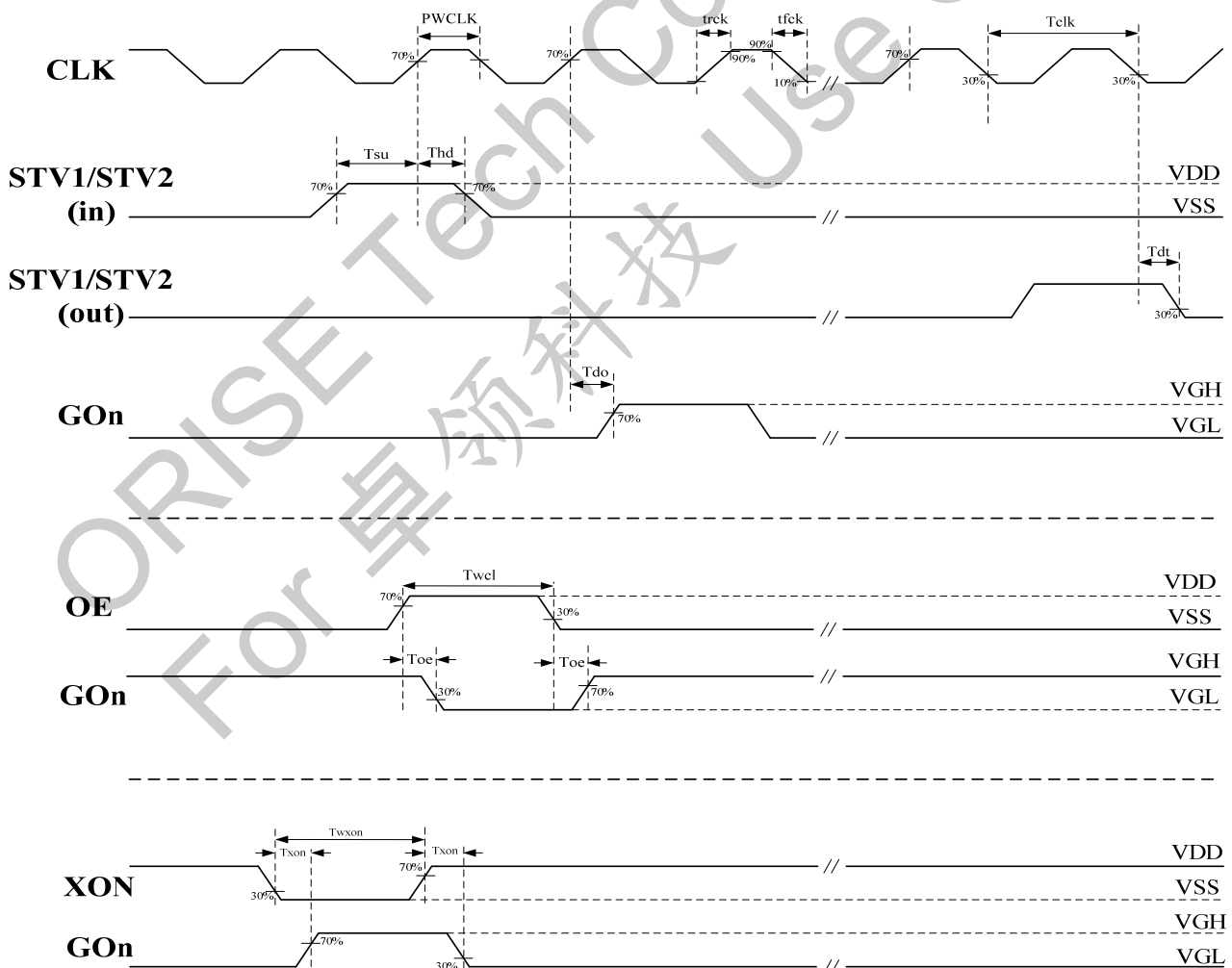
**8.5. Timing Waveforms**

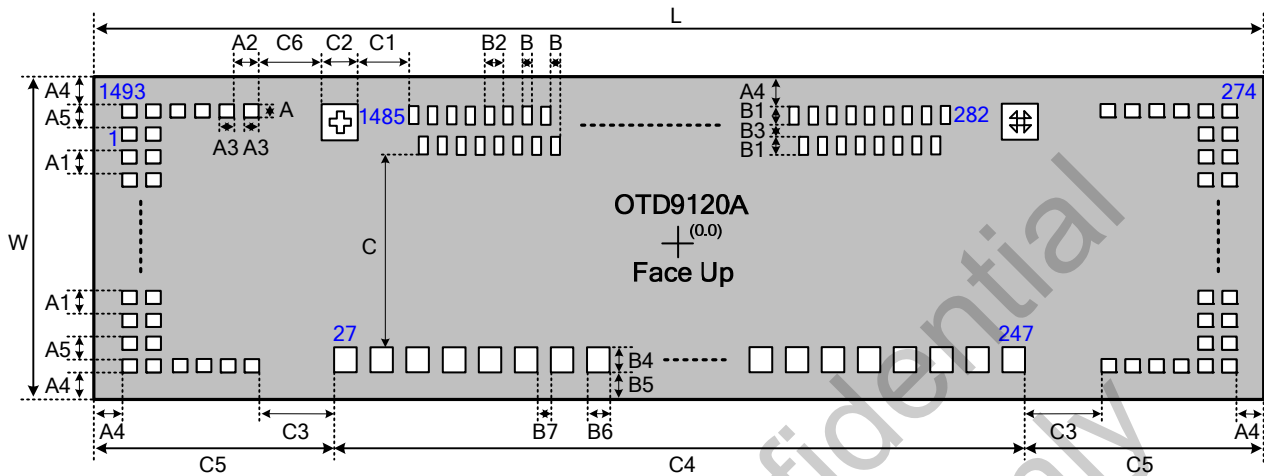
**9. CHIP INFORMATION**
**9.1. PAD Assignment**

**Note1:** Have no Temperature compensation design.

Symbol	Dimensions	Symbol	Dimensions	Symbol	Dimensions
A	32	B2	36	C2	115
A1	52	B3	25	C3	208
A2	90	B4	70	C4	22080
A3	70	B5	57	C5	785
A4	57	B6	80	C6	89
A5	54	B7	20	L	23650
B	18	C	291	W	670
B1	85	C1	199	Unit : um	

(scribe-line included)

**9.2. PAD Dimension**

Item	PAD No.	Size		Unit
		X	Y	
Chip Size		23650	670	μm
Chip thickness		400 ± 20 (OTD9120A-C) 300 ± 20 (OTD9120A-C1) 250 ± 10 (OTD9120A-C2) 300 ± 20 (OTD9120A-C3)		
Pad pitch	(ILB) 27-247	100		
	(OLB) 282-1485	18		
	(SLB) 1-26, 248-281, 1486-1493	52		
Pad size	(ILB) 27-247	80	70	
	(OLB) 282-1485	18	85	
	(SLB) 1-26, 248-281, 1486-1493	70	32	

**Note1:** Chip size included scribe line.

**9.3. PAD Locations**

PAD No.	PAD Name	X	Y
1	IN_OE2	-11733	208
2	IN_OE3	-11733	156
3	IN_U_D	-11733	104
4	IN_U_D	-11643	104
5	IN_CLK	-11733	52
6	IN_CLK	-11643	52
7	PATH	-11733	0
8	PATH	-11643	0
9	IO_STVU	-11733	-52
10	IO_STVU	-11643	-52
11	VGH	-11733	-104
12	VGH	-11643	-104
13	VGL	-11733	-156
14	VDD	-11733	-208
15	VSS	-11733	-262
16	VSS	-11643	-262
17	VDD	-11643	-208
18	VGL	-11643	-156
19	IN_MODE1	-11553	-262
20	IN_MODE1	-11553	-208
21	IN_MODE0	-11463	-262
22	IN_MODE0	-11463	-208
23	IN_SEL1	-11373	-262
24	IN_SEL1	-11373	-208
25	IN_SEL0	-11283	-262
26	IN_SEL0	-11283	-208
27	DUM1	-11000	-243
28	DUM2	-10900	-243
29	DUM3	-10800	-243
30	DUM4	-10700	-243
31	DUM5	-10600	-243
32	DUM6	-10500	-243
33	DUM7	-10400	-243
34	DUM8	-10300	-243
35	DUM9	-10200	-243
36	DUM10	-10100	-243
37	DUM11	-10000	-243
38	DUM12	-9900	-243
39	DUM13	-9800	-243
40	DUM14	-9700	-243
41	DUM15	-9600	-243
42	DUM16	-9500	-243
43	DUM17	-9400	-243
44	DUM18	-9300	-243
45	DUM19	-9200	-243
46	DUM20	-9100	-243
47	DUM21	-9000	-243
48	DUM22	-8900	-243
49	DUM23	-8800	-243
50	DUM24	-8700	-243
51	DUM25	-8600	-243
52	DUM26	-8500	-243

PAD No.	PAD Name	X	Y
53	DUM27	-8400	-243
54	DUM28	-8300	-243
55	DUM29	-8200	-243
56	DUM30	-8100	-243
57	DUM31	-8000	-243
58	DUM32	-7900	-243
59	DUM33	-7800	-243
60	DUM34	-7700	-243
61	DUM35	-7600	-243
62	DUM36	-7500	-243
63	DUM37	-7400	-243
64	DUM38	-7300	-243
65	DUM39	-7200	-243
66	DUM40	-7100	-243
67	DUM41	-7000	-243
68	DUM42	-6900	-243
69	DUM43	-6800	-243
70	DUM44	-6700	-243
71	DUM45	-6600	-243
72	DUM46	-6500	-243
73	DUM47	-6400	-243
74	DUM48	-6300	-243
75	DUM49	-6200	-243
76	DUM50	-6100	-243
77	DUM51	-6000	-243
78	DUM52	-5900	-243
79	DUM53	-5800	-243
80	DUM54	-5700	-243
81	DUM55	-5600	-243
82	DUM56	-5500	-243
83	DUM57	-5400	-243
84	DUM58	-5300	-243
85	DUM59	-5200	-243
86	DUM60	-5100	-243
87	DUM61	-5000	-243
88	DUM62	-4900	-243
89	DUM63	-4800	-243
90	DUM64	-4700	-243
91	DUM65	-4600	-243
92	DUM66	-4500	-243
93	DUM67	-4400	-243
94	DUM68	-4300	-243
95	DUM69	-4200	-243
96	DUM70	-4100	-243
97	DUM71	-4000	-243
98	DUM72	-3900	-243
99	DUM73	-3800	-243
100	DUM74	-3700	-243
101	DUM75	-3600	-243
102	DUM76	-3500	-243
103	DUM77	-3400	-243
104	DUM78	-3300	-243

PAD No.	PAD Name	X	Y
105	DUM79	-3200	-243
106	DUM80	-3100	-243
107	DUM81	-3000	-243
108	DUM82	-2900	-243
109	DUM83	-2800	-243
110	DUM84	-2700	-243
111	DUM85	-2600	-243
112	DUM86	-2500	-243
113	DUM87	-2400	-243
114	DUM88	-2300	-243
115	DUM89	-2200	-243
116	DUM90	-2100	-243
117	DUM91	-2000	-243
118	DUM92	-1900	-243
119	DUM93	-1800	-243
120	DUM94	-1700	-243
121	DUM95	-1600	-243
122	DUM96	-1500	-243
123	DUM97	-1400	-243
124	DUM98	-1300	-243
125	DUM99	-1200	-243
126	DUM100	-1100	-243
127	DUM101	-1000	-243
128	DUM102	-900	-243
129	DUM103	-800	-243
130	DUM104	-700	-243
131	DUM105	-600	-243
132	DUM106	-500	-243
133	DUM107	-400	-243
134	DUM108	-300	-243
135	DUM109	-200	-243
136	DUM110	-100	-243
137	DUM111	0	-243
138	DUM112	100	-243
139	DUM113	200	-243
140	DUM114	300	-243
141	DUM115	400	-243
142	DUM116	500	-243
143	DUM117	600	-243
144	DUM118	700	-243
145	DUM119	800	-243
146	DUM120	900	-243
147	DUM121	1000	-243
148	DUM122	1100	-243
149	DUM123	1200	-243
150	DUM124	1300	-243
151	DUM125	1400	-243
152	DUM126	1500	-243
153	DUM127	1600	-243
154	DUM128	1700	-243
155	DUM129	1800	-243
156	DUM130	1900	-243

PAD No.	PAD Name	X	Y
157	DUM131	2000	-243
158	DUM132	2100	-243
159	DUM133	2200	-243
160	DUM134	2300	-243
161	DUM135	2400	-243
162	DUM136	2500	-243
163	DUM137	2600	-243
164	DUM138	2700	-243
165	DUM139	2800	-243
166	DUM140	2900	-243
167	DUM141	3000	-243
168	DUM142	3100	-243
169	DUM143	3200	-243
170	DUM144	3300	-243
171	DUM145	3400	-243
172	DUM146	3500	-243
173	DUM147	3600	-243
174	DUM148	3700	-243
175	DUM149	3800	-243
176	DUM150	3900	-243
177	DUM151	4000	-243
178	DUM152	4100	-243
179	DUM153	4200	-243
180	DUM154	4300	-243
181	DUM155	4400	-243
182	DUM156	4500	-243
183	DUM157	4600	-243
184	DUM158	4700	-243
185	DUM159	4800	-243
186	DUM160	4900	-243
187	DUM161	5000	-243
188	DUM162	5100	-243
189	DUM163	5200	-243
190	DUM164	5300	-243
191	DUM165	5400	-243
192	DUM166	5500	-243
193	DUM167	5600	-243
194	DUM168	5700	-243
195	DUM169	5800	-243
196	DUM170	5900	-243
197	DUM171	6000	-243
198	DUM172	6100	-243
199	DUM173	6200	-243
200	DUM174	6300	-243
201	DUM175	6400	-243
202	DUM176	6500	-243
203	DUM177	6600	-243
204	DUM178	6700	-243
205	DUM179	6800	-243
206	DUM180	6900	-243
207	DUM181	7000	-243
208	DUM182	7100	-243
209	DUM183	7200	-243

PAD No.	PAD Name	X	Y
210	DUM184	7300	-243
211	DUM185	7400	-243
212	DUM186	7500	-243
213	DUM187	7600	-243
214	DUM188	7700	-243
215	DUM189	7800	-243
216	DUM190	7900	-243
217	DUM191	8000	-243
218	DUM192	8100	-243
219	DUM193	8200	-243
220	DUM194	8300	-243
221	DUM195	8400	-243
222	DUM196	8500	-243
223	DUM197	8600	-243
224	DUM198	8700	-243
225	DUM199	8800	-243
226	DUM200	8900	-243
227	DUM201	9000	-243
228	DUM202	9100	-243
229	DUM203	9200	-243
230	DUM204	9300	-243
231	DUM205	9400	-243
232	DUM206	9500	-243
233	DUM207	9600	-243
234	DUM208	9700	-243
235	DUM209	9800	-243
236	DUM210	9900	-243
237	DUM211	10000	-243
238	DUM212	10100	-243
239	DUM213	10200	-243
240	DUM214	10300	-243
241	DUM215	10400	-243
242	DUM216	10500	-243
243	DUM217	10600	-243
244	DUM218	10700	-243
245	DUM219	10800	-243
246	DUM220	10900	-243
247	DUM221	11000	-243
248	IN_SEL0	11283	-262
249	IN_SEL0	11283	-208
250	IN_SEL1	11373	-262
251	IN_SEL1	11373	-208
252	IN_MODE0	11463	-262
253	IN_MODE0	11463	-208
254	IN_MODE1	11553	-262
255	IN_MODE1	11553	-208
256	VSS	11643	-262
257	VDD	11643	-208
258	VGL	11643	-156
259	VSS	11733	-262
260	VDD	11733	-208
261	VGL	11733	-156
262	VGH	11643	-104

PAD No.	PAD Name	X	Y
263	VGH	11733	-104
264	IO_STVD	11643	-52
265	IO_STVD	11733	-52
266	PATH	11643	0
267	PATH	11733	0
268	IN_CLK	11643	52
269	IN_CLK	11733	52
270	IN_U_D	11643	104
271	IN_U_D	11733	104
272	IN_OE3	11733	156
273	IN_OE2	11733	208
274	IN_OE1	11733	262
275	IN_OE3	11643	156
276	IN_OE2	11643	208
277	IN_OE1	11643	262
278	IN_F_CTRL	11553	262
279	IN_F_CTRL	11463	262
280	IN_XON	11373	262
281	IN_XON	11283	262
282	DUM223	10836	235.5
283	VGL	10800	235.5
284	OG1	10782	125.5
285	OG2	10764	235.5
286	OG3	10746	125.5
287	OG4	10728	235.5
288	OG5	10710	125.5
289	OG6	10692	235.5
290	OG7	10674	125.5
291	OG8	10656	235.5
292	OG9	10638	125.5
293	OG10	10620	235.5
294	OG11	10602	125.5
295	OG12	10584	235.5
296	OG13	10566	125.5
297	OG14	10548	235.5
298	OG15	10530	125.5
299	OG16	10512	235.5
300	OG17	10494	125.5
301	OG18	10476	235.5
302	OG19	10458	125.5
303	OG20	10440	235.5
304	OG21	10422	125.5
305	OG22	10404	235.5
306	OG23	10386	125.5
307	OG24	10368	235.5
308	OG25	10350	125.5
309	OG26	10332	235.5
310	OG27	10314	125.5
311	OG28	10296	235.5
312	OG29	10278	125.5
313	OG30	10260	235.5
314	OG31	10242	125.5
315	OG32	10224	235.5



PAD No.	PAD Name	X	Y
316	OG33	10206	125.5
317	OG34	10188	235.5
318	OG35	10170	125.5
319	OG36	10152	235.5
320	OG37	10134	125.5
321	OG38	10116	235.5
322	OG39	10098	125.5
323	OG40	10080	235.5
324	OG41	10062	125.5
325	OG42	10044	235.5
326	OG43	10026	125.5
327	OG44	10008	235.5
328	OG45	9990	125.5
329	OG46	9972	235.5
330	OG47	9954	125.5
331	OG48	9936	235.5
332	OG49	9918	125.5
333	OG50	9900	235.5
334	OG51	9882	125.5
335	OG52	9864	235.5
336	OG53	9846	125.5
337	OG54	9828	235.5
338	OG55	9810	125.5
339	OG56	9792	235.5
340	OG57	9774	125.5
341	OG58	9756	235.5
342	OG59	9738	125.5
343	OG60	9720	235.5
344	OG61	9702	125.5
345	OG62	9684	235.5
346	OG63	9666	125.5
347	OG64	9648	235.5
348	OG65	9630	125.5
349	OG66	9612	235.5
350	OG67	9594	125.5
351	OG68	9576	235.5
352	OG69	9558	125.5
353	OG70	9540	235.5
354	OG71	9522	125.5
355	OG72	9504	235.5
356	OG73	9486	125.5
357	OG74	9468	235.5
358	OG75	9450	125.5
359	OG76	9432	235.5
360	OG77	9414	125.5
361	OG78	9396	235.5
362	OG79	9378	125.5
363	OG80	9360	235.5
364	OG81	9342	125.5
365	OG82	9324	235.5
366	OG83	9306	125.5
367	OG84	9288	235.5
368	OG85	9270	125.5

PAD No.	PAD Name	X	Y
369	OG86	9252	235.5
370	OG87	9234	125.5
371	OG88	9216	235.5
372	OG89	9198	125.5
373	OG90	9180	235.5
374	OG91	9162	125.5
375	OG92	9144	235.5
376	OG93	9126	125.5
377	OG94	9108	235.5
378	OG95	9090	125.5
379	OG96	9072	235.5
380	OG97	9054	125.5
381	OG98	9036	235.5
382	OG99	9018	125.5
383	OG100	9000	235.5
384	OG101	8982	125.5
385	OG102	8964	235.5
386	OG103	8946	125.5
387	OG104	8928	235.5
388	OG105	8910	125.5
389	OG106	8892	235.5
390	OG107	8874	125.5
391	OG108	8856	235.5
392	OG109	8838	125.5
393	OG110	8820	235.5
394	OG111	8802	125.5
395	OG112	8784	235.5
396	OG113	8766	125.5
397	OG114	8748	235.5
398	OG115	8730	125.5
399	OG116	8712	235.5
400	OG117	8694	125.5
401	OG118	8676	235.5
402	OG119	8658	125.5
403	OG120	8640	235.5
404	OG121	8622	125.5
405	OG122	8604	235.5
406	OG123	8586	125.5
407	OG124	8568	235.5
408	OG125	8550	125.5
409	OG126	8532	235.5
410	OG127	8514	125.5
411	OG128	8496	235.5
412	OG129	8478	125.5
413	OG130	8460	235.5
414	OG131	8442	125.5
415	OG132	8424	235.5
416	OG133	8406	125.5
417	OG134	8388	235.5
418	OG135	8370	125.5
419	OG136	8352	235.5
420	OG137	8334	125.5
421	OG138	8316	235.5

PAD No.	PAD Name	X	Y
422	OG139	8298	125.5
423	OG140	8280	235.5
424	OG141	8262	125.5
425	OG142	8244	235.5
426	OG143	8226	125.5
427	OG144	8208	235.5
428	OG145	8190	125.5
429	OG146	8172	235.5
430	OG147	8154	125.5
431	OG148	8136	235.5
432	OG149	8118	125.5
433	OG150	8100	235.5
434	OG151	8082	125.5
435	OG152	8064	235.5
436	OG153	8046	125.5
437	OG154	8028	235.5
438	OG155	8010	125.5
439	OG156	7992	235.5
440	OG157	7974	125.5
441	OG158	7956	235.5
442	OG159	7938	125.5
443	OG160	7920	235.5
444	OG161	7902	125.5
445	OG162	7884	235.5
446	OG163	7866	125.5
447	OG164	7848	235.5
448	OG165	7830	125.5
449	OG166	7812	235.5
450	OG167	7794	125.5
451	OG168	7776	235.5
452	OG169	7758	125.5
453	OG170	7740	235.5
454	OG171	7722	125.5
455	OG172	7704	235.5
456	OG173	7686	125.5
457	OG174	7668	235.5
458	OG175	7650	125.5
459	OG176	7632	235.5
460	OG177	7614	125.5
461	OG178	7596	235.5
462	OG179	7578	125.5
463	OG180	7560	235.5
464	OG181	7542	125.5
465	OG182	7524	235.5
466	OG183	7506	125.5
467	OG184	7488	235.5
468	OG185	7470	125.5
469	OG186	7452	235.5
470	OG187	7434	125.5
471	OG188	7416	235.5
472	OG189	7398	125.5
473	OG190	7380	235.5
474	OG191	7362	125.5

PAD No.	PAD Name	X	Y
475	OG192	7344	235.5
476	OG193	7326	125.5
477	OG194	7308	235.5
478	OG195	7290	125.5
479	OG196	7272	235.5
480	OG197	7254	125.5
481	OG198	7236	235.5
482	OG199	7218	125.5
483	OG200	7200	235.5
484	OG201	7182	125.5
485	OG202	7164	235.5
486	OG203	7146	125.5
487	OG204	7128	235.5
488	OG205	7110	125.5
489	OG206	7092	235.5
490	OG207	7074	125.5
491	OG208	7056	235.5
492	OG209	7038	125.5
493	OG210	7020	235.5
494	OG211	7002	125.5
495	OG212	6984	235.5
496	OG213	6966	125.5
497	OG214	6948	235.5
498	OG215	6930	125.5
499	OG216	6912	235.5
500	OG217	6894	125.5
501	OG218	6876	235.5
502	OG219	6858	125.5
503	OG220	6840	235.5
504	OG221	6822	125.5
505	OG222	6804	235.5
506	OG223	6786	125.5
507	OG224	6768	235.5
508	OG225	6750	125.5
509	OG226	6732	235.5
510	OG227	6714	125.5
511	OG228	6696	235.5
512	OG229	6678	125.5
513	OG230	6660	235.5
514	OG231	6642	125.5
515	OG232	6624	235.5
516	OG233	6606	125.5
517	OG234	6588	235.5
518	OG235	6570	125.5
519	OG236	6552	235.5
520	OG237	6534	125.5
521	OG238	6516	235.5
522	OG239	6498	125.5
523	OG240	6480	235.5
524	OG241	6462	125.5
525	OG242	6444	235.5
526	OG243	6426	125.5
527	OG244	6408	235.5

PAD No.	PAD Name	X	Y
528	OG245	6390	125.5
529	OG246	6372	235.5
530	OG247	6354	125.5
531	OG248	6336	235.5
532	OG249	6318	125.5
533	OG250	6300	235.5
534	OG251	6282	125.5
535	OG252	6264	235.5
536	OG253	6246	125.5
537	OG254	6228	235.5
538	OG255	6210	125.5
539	OG256	6192	235.5
540	OG257	6174	125.5
541	OG258	6156	235.5
542	OG259	6138	125.5
543	OG260	6120	235.5
544	OG261	6102	125.5
545	OG262	6084	235.5
546	OG263	6066	125.5
547	OG264	6048	235.5
548	OG265	6030	125.5
549	OG266	6012	235.5
550	OG267	5994	125.5
551	OG268	5976	235.5
552	OG269	5958	125.5
553	OG270	5940	235.5
554	OG271	5922	125.5
555	OG272	5904	235.5
556	OG273	5886	125.5
557	OG274	5868	235.5
558	OG275	5850	125.5
559	OG276	5832	235.5
560	OG277	5814	125.5
561	OG278	5796	235.5
562	OG279	5778	125.5
563	OG280	5760	235.5
564	OG281	5742	125.5
565	OG282	5724	235.5
566	OG283	5706	125.5
567	OG284	5688	235.5
568	OG285	5670	125.5
569	OG286	5652	235.5
570	OG287	5634	125.5
571	OG288	5616	235.5
572	OG289	5598	125.5
573	OG290	5580	235.5
574	OG291	5562	125.5
575	OG292	5544	235.5
576	OG293	5526	125.5
577	OG294	5508	235.5
578	OG295	5490	125.5
579	OG296	5472	235.5
580	OG297	5454	125.5

PAD No.	PAD Name	X	Y
581	OG298	5436	235.5
582	OG299	5418	125.5
583	OG300	5400	235.5
584	OG301	5382	125.5
585	OG302	5364	235.5
586	OG303	5346	125.5
587	OG304	5328	235.5
588	OG305	5310	125.5
589	OG306	5292	235.5
590	OG307	5274	125.5
591	OG308	5256	235.5
592	OG309	5238	125.5
593	OG310	5220	235.5
594	OG311	5202	125.5
595	OG312	5184	235.5
596	OG313	5166	125.5
597	OG314	5148	235.5
598	OG315	5130	125.5
599	OG316	5112	235.5
600	OG317	5094	125.5
601	OG318	5076	235.5
602	OG319	5058	125.5
603	OG320	5040	235.5
604	OG321	5022	125.5
605	OG322	5004	235.5
606	OG323	4986	125.5
607	OG324	4968	235.5
608	OG325	4950	125.5
609	OG326	4932	235.5
610	OG327	4914	125.5
611	OG328	4896	235.5
612	OG329	4878	125.5
613	OG330	4860	235.5
614	OG331	4842	125.5
615	OG332	4824	235.5
616	OG333	4806	125.5
617	OG334	4788	235.5
618	OG335	4770	125.5
619	OG336	4752	235.5
620	OG337	4734	125.5
621	OG338	4716	235.5
622	OG339	4698	125.5
623	OG340	4680	235.5
624	OG341	4662	125.5
625	OG342	4644	235.5
626	OG343	4626	125.5
627	OG344	4608	235.5
628	OG345	4590	125.5
629	OG346	4572	235.5
630	OG347	4554	125.5
631	OG348	4536	235.5
632	OG349	4518	125.5
633	OG350	4500	235.5

PAD No.	PAD Name	X	Y
634	OG351	4482	125.5
635	OG352	4464	235.5
636	OG353	4446	125.5
637	OG354	4428	235.5
638	OG355	4410	125.5
639	OG356	4392	235.5
640	OG357	4374	125.5
641	OG358	4356	235.5
642	OG359	4338	125.5
643	OG360	4320	235.5
644	OG361	4302	125.5
645	OG362	4284	235.5
646	OG363	4266	125.5
647	OG364	4248	235.5
648	OG365	4230	125.5
649	OG366	4212	235.5
650	OG367	4194	125.5
651	OG368	4176	235.5
652	OG369	4158	125.5
653	OG370	4140	235.5
654	OG371	4122	125.5
655	OG372	4104	235.5
656	OG373	4086	125.5
657	OG374	4068	235.5
658	OG375	4050	125.5
659	OG376	4032	235.5
660	OG377	4014	125.5
661	OG378	3996	235.5
662	OG379	3978	125.5
663	OG380	3960	235.5
664	OG381	3942	125.5
665	OG382	3924	235.5
666	OG383	3906	125.5
667	OG384	3888	235.5
668	OG385	3870	125.5
669	OG386	3852	235.5
670	OG387	3834	125.5
671	OG388	3816	235.5
672	OG389	3798	125.5
673	OG390	3780	235.5
674	OG391	3762	125.5
675	OG392	3744	235.5
676	OG393	3726	125.5
677	OG394	3708	235.5
678	OG395	3690	125.5
679	OG396	3672	235.5
680	OG397	3654	125.5
681	OG398	3636	235.5
682	OG399	3618	125.5
683	OG400	3600	235.5
684	OG401	3582	125.5
685	OG402	3564	235.5
686	OG403	3546	125.5

PAD No.	PAD Name	X	Y
687	OG404	3528	235.5
688	OG405	3510	125.5
689	OG406	3492	235.5
690	OG407	3474	125.5
691	OG408	3456	235.5
692	OG409	3438	125.5
693	OG410	3420	235.5
694	OG411	3402	125.5
695	OG412	3384	235.5
696	OG413	3366	125.5
697	OG414	3348	235.5
698	OG415	3330	125.5
699	OG416	3312	235.5
700	OG417	3294	125.5
701	OG418	3276	235.5
702	OG419	3258	125.5
703	OG420	3240	235.5
704	OG421	3222	125.5
705	OG422	3204	235.5
706	OG423	3186	125.5
707	OG424	3168	235.5
708	OG425	3150	125.5
709	OG426	3132	235.5
710	OG427	3114	125.5
711	OG428	3096	235.5
712	OG429	3078	125.5
713	OG430	3060	235.5
714	OG431	3042	125.5
715	OG432	3024	235.5
716	OG433	3006	125.5
717	OG434	2988	235.5
718	OG435	2970	125.5
719	OG436	2952	235.5
720	OG437	2934	125.5
721	OG438	2916	235.5
722	OG439	2898	125.5
723	OG440	2880	235.5
724	OG441	2862	125.5
725	OG442	2844	235.5
726	OG443	2826	125.5
727	OG444	2808	235.5
728	OG445	2790	125.5
729	OG446	2772	235.5
730	OG447	2754	125.5
731	OG448	2736	235.5
732	OG449	2718	125.5
733	OG450	2700	235.5
734	OG451	2682	125.5
735	OG452	2664	235.5
736	OG453	2646	125.5
737	OG454	2628	235.5
738	OG455	2610	125.5
739	OG456	2592	235.5

PAD No.	PAD Name	X	Y
740	OG457	2574	125.5
741	OG458	2556	235.5
742	OG459	2538	125.5
743	OG460	2520	235.5
744	OG461	2502	125.5
745	OG462	2484	235.5
746	OG463	2466	125.5
747	OG464	2448	235.5
748	OG465	2430	125.5
749	OG466	2412	235.5
750	OG467	2394	125.5
751	OG468	2376	235.5
752	OG469	2358	125.5
753	OG470	2340	235.5
754	OG471	2322	125.5
755	OG472	2304	235.5
756	OG473	2286	125.5
757	OG474	2268	235.5
758	OG475	2250	125.5
759	OG476	2232	235.5
760	OG477	2214	125.5
761	OG478	2196	235.5
762	OG479	2178	125.5
763	OG480	2160	235.5
764	OG481	2142	125.5
765	OG482	2124	235.5
766	OG483	2106	125.5
767	OG484	2088	235.5
768	OG485	2070	125.5
769	OG486	2052	235.5
770	OG487	2034	125.5
771	OG488	2016	235.5
772	OG489	1998	125.5
773	OG490	1980	235.5
774	OG491	1962	125.5
775	OG492	1944	235.5
776	OG493	1926	125.5
777	OG494	1908	235.5
778	OG495	1890	125.5
779	OG496	1872	235.5
780	OG497	1854	125.5
781	OG498	1836	235.5
782	OG499	1818	125.5
783	OG500	1800	235.5
784	OG501	1782	125.5
785	OG502	1764	235.5
786	OG503	1746	125.5
787	OG504	1728	235.5
788	OG505	1710	125.5
789	OG506	1692	235.5
790	OG507	1674	125.5
791	OG508	1656	235.5
792	OG509	1638	125.5

PAD No.	PAD Name	X	Y
793	OG510	1620	235.5
794	OG511	1602	125.5
795	OG512	1584	235.5
796	OG513	1566	125.5
797	OG514	1548	235.5
798	OG515	1530	125.5
799	OG516	1512	235.5
800	OG517	1494	125.5
801	OG518	1476	235.5
802	OG519	1458	125.5
803	OG520	1440	235.5
804	OG521	1422	125.5
805	OG522	1404	235.5
806	OG523	1386	125.5
807	OG524	1368	235.5
808	OG525	1350	125.5
809	OG526	1332	235.5
810	OG527	1314	125.5
811	OG528	1296	235.5
812	OG529	1278	125.5
813	OG530	1260	235.5
814	OG531	1242	125.5
815	OG532	1224	235.5
816	OG533	1206	125.5
817	OG534	1188	235.5
818	OG535	1170	125.5
819	OG536	1152	235.5
820	OG537	1134	125.5
821	OG538	1116	235.5
822	OG539	1098	125.5
823	OG540	1080	235.5
824	OG541	1062	125.5
825	OG542	1044	235.5
826	OG543	1026	125.5
827	OG544	1008	235.5
828	OG545	990	125.5
829	OG546	972	235.5
830	OG547	954	125.5
831	OG548	936	235.5
832	OG549	918	125.5
833	OG550	900	235.5
834	OG551	882	125.5
835	OG552	864	235.5
836	OG553	846	125.5
837	OG554	828	235.5
838	OG555	810	125.5
839	OG556	792	235.5
840	OG557	774	125.5
841	OG558	756	235.5
842	OG559	738	125.5
843	OG560	720	235.5
844	OG561	702	125.5
845	OG562	684	235.5

PAD No.	PAD Name	X	Y
846	OG563	666	125.5
847	OG564	648	235.5
848	OG565	630	125.5
849	OG566	612	235.5
850	OG567	594	125.5
851	OG568	576	235.5
852	OG569	558	125.5
853	OG570	540	235.5
854	OG571	522	125.5
855	OG572	504	235.5
856	OG573	486	125.5
857	OG574	468	235.5
858	OG575	450	125.5
859	OG576	432	235.5
860	OG577	414	125.5
861	OG578	396	235.5
862	OG579	378	125.5
863	OG580	360	235.5
864	OG581	342	125.5
865	OG582	324	235.5
866	OG583	306	125.5
867	OG584	288	235.5
868	OG585	270	125.5
869	OG586	252	235.5
870	OG587	234	125.5
871	OG588	216	235.5
872	OG589	198	125.5
873	OG590	180	235.5
874	OG591	162	125.5
875	OG592	144	235.5
876	OG593	126	125.5
877	OG594	108	235.5
878	OG595	90	125.5
879	OG596	72	235.5
880	OG597	54	125.5
881	OG598	36	235.5
882	OG599	18	125.5
883	OG600	0	235.5
884	OG601	-18	125.5
885	OG602	-36	235.5
886	OG603	-54	125.5
887	OG604	-72	235.5
888	OG605	-90	125.5
889	OG606	-108	235.5
890	OG607	-126	125.5
891	OG608	-144	235.5
892	OG609	-162	125.5
893	OG610	-180	235.5
894	OG611	-198	125.5
895	OG612	-216	235.5
896	OG613	-234	125.5
897	OG614	-252	235.5
898	OG615	-270	125.5

PAD No.	PAD Name	X	Y
899	OG616	-288	235.5
900	OG617	-306	125.5
901	OG618	-324	235.5
902	OG619	-342	125.5
903	OG620	-360	235.5
904	OG621	-378	125.5
905	OG622	-396	235.5
906	OG623	-414	125.5
907	OG624	-432	235.5
908	OG625	-450	125.5
909	OG626	-468	235.5
910	OG627	-486	125.5
911	OG628	-504	235.5
912	OG629	-522	125.5
913	OG630	-540	235.5
914	OG631	-558	125.5
915	OG632	-576	235.5
916	OG633	-594	125.5
917	OG634	-612	235.5
918	OG635	-630	125.5
919	OG636	-648	235.5
920	OG637	-666	125.5
921	OG638	-684	235.5
922	OG639	-702	125.5
923	OG640	-720	235.5
924	OG641	-738	125.5
925	OG642	-756	235.5
926	OG643	-774	125.5
927	OG644	-792	235.5
928	OG645	-810	125.5
929	OG646	-828	235.5
930	OG647	-846	125.5
931	OG648	-864	235.5
932	OG649	-882	125.5
933	OG650	-900	235.5
934	OG651	-918	125.5
935	OG652	-936	235.5
936	OG653	-954	125.5
937	OG654	-972	235.5
938	OG655	-990	125.5
939	OG656	-1008	235.5
940	OG657	-1026	125.5
941	OG658	-1044	235.5
942	OG659	-1062	125.5
943	OG660	-1080	235.5
944	OG661	-1098	125.5
945	OG662	-1116	235.5
946	OG663	-1134	125.5
947	OG664	-1152	235.5
948	OG665	-1170	125.5
949	OG666	-1188	235.5
950	OG667	-1206	125.5
951	OG668	-1224	235.5

PAD No.	PAD Name	X	Y
952	OG669	-1242	125.5
953	OG670	-1260	235.5
954	OG671	-1278	125.5
955	OG672	-1296	235.5
956	OG673	-1314	125.5
957	OG674	-1332	235.5
958	OG675	-1350	125.5
959	OG676	-1368	235.5
960	OG677	-1386	125.5
961	OG678	-1404	235.5
962	OG679	-1422	125.5
963	OG680	-1440	235.5
964	OG681	-1458	125.5
965	OG682	-1476	235.5
966	OG683	-1494	125.5
967	OG684	-1512	235.5
968	OG685	-1530	125.5
969	OG686	-1548	235.5
970	OG687	-1566	125.5
971	OG688	-1584	235.5
972	OG689	-1602	125.5
973	OG690	-1620	235.5
974	OG691	-1638	125.5
975	OG692	-1656	235.5
976	OG693	-1674	125.5
977	OG694	-1692	235.5
978	OG695	-1710	125.5
979	OG696	-1728	235.5
980	OG697	-1746	125.5
981	OG698	-1764	235.5
982	OG699	-1782	125.5
983	OG700	-1800	235.5
984	OG701	-1818	125.5
985	OG702	-1836	235.5
986	OG703	-1854	125.5
987	OG704	-1872	235.5
988	OG705	-1890	125.5
989	OG706	-1908	235.5
990	OG707	-1926	125.5
991	OG708	-1944	235.5
992	OG709	-1962	125.5
993	OG710	-1980	235.5
994	OG711	-1998	125.5
995	OG712	-2016	235.5
996	OG713	-2034	125.5
997	OG714	-2052	235.5
998	OG715	-2070	125.5
999	OG716	-2088	235.5
1000	OG717	-2106	125.5
1001	OG718	-2124	235.5
1002	OG719	-2142	125.5
1003	OG720	-2160	235.5
1004	OG721	-2178	125.5

PAD No.	PAD Name	X	Y
1005	OG722	-2196	235.5
1006	OG723	-2214	125.5
1007	OG724	-2232	235.5
1008	OG725	-2250	125.5
1009	OG726	-2268	235.5
1010	OG727	-2286	125.5
1011	OG728	-2304	235.5
1012	OG729	-2322	125.5
1013	OG730	-2340	235.5
1014	OG731	-2358	125.5
1015	OG732	-2376	235.5
1016	OG733	-2394	125.5
1017	OG734	-2412	235.5
1018	OG735	-2430	125.5
1019	OG736	-2448	235.5
1020	OG737	-2466	125.5
1021	OG738	-2484	235.5
1022	OG739	-2502	125.5
1023	OG740	-2520	235.5
1024	OG741	-2538	125.5
1025	OG742	-2556	235.5
1026	OG743	-2574	125.5
1027	OG744	-2592	235.5
1028	OG745	-2610	125.5
1029	OG746	-2628	235.5
1030	OG747	-2646	125.5
1031	OG748	-2664	235.5
1032	OG749	-2682	125.5
1033	OG750	-2700	235.5
1034	OG751	-2718	125.5
1035	OG752	-2736	235.5
1036	OG753	-2754	125.5
1037	OG754	-2772	235.5
1038	OG755	-2790	125.5
1039	OG756	-2808	235.5
1040	OG757	-2826	125.5
1041	OG758	-2844	235.5
1042	OG759	-2862	125.5
1043	OG760	-2880	235.5
1044	OG761	-2898	125.5
1045	OG762	-2916	235.5
1046	OG763	-2934	125.5
1047	OG764	-2952	235.5
1048	OG765	-2970	125.5
1049	OG766	-2988	235.5
1050	OG767	-3006	125.5
1051	OG768	-3024	235.5
1052	OG769	-3042	125.5
1053	OG770	-3060	235.5
1054	OG771	-3078	125.5
1055	OG772	-3096	235.5
1056	OG773	-3114	125.5
1057	OG774	-3132	235.5

PAD No.	PAD Name	X	Y
1058	OG775	-3150	125.5
1059	OG776	-3168	235.5
1060	OG777	-3186	125.5
1061	OG778	-3204	235.5
1062	OG779	-3222	125.5
1063	OG780	-3240	235.5
1064	OG781	-3258	125.5
1065	OG782	-3276	235.5
1066	OG783	-3294	125.5
1067	OG784	-3312	235.5
1068	OG785	-3330	125.5
1069	OG786	-3348	235.5
1070	OG787	-3366	125.5
1071	OG788	-3384	235.5
1072	OG789	-3402	125.5
1073	OG790	-3420	235.5
1074	OG791	-3438	125.5
1075	OG792	-3456	235.5
1076	OG793	-3474	125.5
1077	OG794	-3492	235.5
1078	OG795	-3510	125.5
1079	OG796	-3528	235.5
1080	OG797	-3546	125.5
1081	OG798	-3564	235.5
1082	OG799	-3582	125.5
1083	OG800	-3600	235.5
1084	OG801	-3618	125.5
1085	OG802	-3636	235.5
1086	OG803	-3654	125.5
1087	OG804	-3672	235.5
1088	OG805	-3690	125.5
1089	OG806	-3708	235.5
1090	OG807	-3726	125.5
1091	OG808	-3744	235.5
1092	OG809	-3762	125.5
1093	OG810	-3780	235.5
1094	OG811	-3798	125.5
1095	OG812	-3816	235.5
1096	OG813	-3834	125.5
1097	OG814	-3852	235.5
1098	OG815	-3870	125.5
1099	OG816	-3888	235.5
1100	OG817	-3906	125.5
1101	OG818	-3924	235.5
1102	OG819	-3942	125.5
1103	OG820	-3960	235.5
1104	OG821	-3978	125.5
1105	OG822	-3996	235.5
1106	OG823	-4014	125.5
1107	OG824	-4032	235.5
1108	OG825	-4050	125.5
1109	OG826	-4068	235.5
1110	OG827	-4086	125.5

PAD No.	PAD Name	X	Y
1111	OG828	-4104	235.5
1112	OG829	-4122	125.5
1113	OG830	-4140	235.5
1114	OG831	-4158	125.5
1115	OG832	-4176	235.5
1116	OG833	-4194	125.5
1117	OG834	-4212	235.5
1118	OG835	-4230	125.5
1119	OG836	-4248	235.5
1120	OG837	-4266	125.5
1121	OG838	-4284	235.5
1122	OG839	-4302	125.5
1123	OG840	-4320	235.5
1124	OG841	-4338	125.5
1125	OG842	-4356	235.5
1126	OG843	-4374	125.5
1127	OG844	-4392	235.5
1128	OG845	-4410	125.5
1129	OG846	-4428	235.5
1130	OG847	-4446	125.5
1131	OG848	-4464	235.5
1132	OG849	-4482	125.5
1133	OG850	-4500	235.5
1134	OG851	-4518	125.5
1135	OG852	-4536	235.5
1136	OG853	-4554	125.5
1137	OG854	-4572	235.5
1138	OG855	-4590	125.5
1139	OG856	-4608	235.5
1140	OG857	-4626	125.5
1141	OG858	-4644	235.5
1142	OG859	-4662	125.5
1143	OG860	-4680	235.5
1144	OG861	-4698	125.5
1145	OG862	-4716	235.5
1146	OG863	-4734	125.5
1147	OG864	-4752	235.5
1148	OG865	-4770	125.5
1149	OG866	-4788	235.5
1150	OG867	-4806	125.5
1151	OG868	-4824	235.5
1152	OG869	-4842	125.5
1153	OG870	-4860	235.5
1154	OG871	-4878	125.5
1155	OG872	-4896	235.5
1156	OG873	-4914	125.5
1157	OG874	-4932	235.5
1158	OG875	-4950	125.5
1159	OG876	-4968	235.5
1160	OG877	-4986	125.5
1161	OG878	-5004	235.5
1162	OG879	-5022	125.5
1163	OG880	-5040	235.5

PAD No.	PAD Name	X	Y
1164	OG881	-5058	125.5
1165	OG882	-5076	235.5
1166	OG883	-5094	125.5
1167	OG884	-5112	235.5
1168	OG885	-5130	125.5
1169	OG886	-5148	235.5
1170	OG887	-5166	125.5
1171	OG888	-5184	235.5
1172	OG889	-5202	125.5
1173	OG890	-5220	235.5
1174	OG891	-5238	125.5
1175	OG892	-5256	235.5
1176	OG893	-5274	125.5
1177	OG894	-5292	235.5
1178	OG895	-5310	125.5
1179	OG896	-5328	235.5
1180	OG897	-5346	125.5
1181	OG898	-5364	235.5
1182	OG899	-5382	125.5
1183	OG900	-5400	235.5
1184	OG901	-5418	125.5
1185	OG902	-5436	235.5
1186	OG903	-5454	125.5
1187	OG904	-5472	235.5
1188	OG905	-5490	125.5
1189	OG906	-5508	235.5
1190	OG907	-5526	125.5
1191	OG908	-5544	235.5
1192	OG909	-5562	125.5
1193	OG910	-5580	235.5
1194	OG911	-5598	125.5
1195	OG912	-5616	235.5
1196	OG913	-5634	125.5
1197	OG914	-5652	235.5
1198	OG915	-5670	125.5
1199	OG916	-5688	235.5
1200	OG917	-5706	125.5
1201	OG918	-5724	235.5
1202	OG919	-5742	125.5
1203	OG920	-5760	235.5
1204	OG921	-5778	125.5
1205	OG922	-5796	235.5
1206	OG923	-5814	125.5
1207	OG924	-5832	235.5
1208	OG925	-5850	125.5
1209	OG926	-5868	235.5
1210	OG927	-5886	125.5
1211	OG928	-5904	235.5
1212	OG929	-5922	125.5
1213	OG930	-5940	235.5
1214	OG931	-5958	125.5
1215	OG932	-5976	235.5
1216	OG933	-5994	125.5

PAD No.	PAD Name	X	Y
1217	OG934	-6012	235.5
1218	OG935	-6030	125.5
1219	OG936	-6048	235.5
1220	OG937	-6066	125.5
1221	OG938	-6084	235.5
1222	OG939	-6102	125.5
1223	OG940	-6120	235.5
1224	OG941	-6138	125.5
1225	OG942	-6156	235.5
1226	OG943	-6174	125.5
1227	OG944	-6192	235.5
1228	OG945	-6210	125.5
1229	OG946	-6228	235.5
1230	OG947	-6246	125.5
1231	OG948	-6264	235.5
1232	OG949	-6282	125.5
1233	OG950	-6300	235.5
1234	OG951	-6318	125.5
1235	OG952	-6336	235.5
1236	OG953	-6354	125.5
1237	OG954	-6372	235.5
1238	OG955	-6390	125.5
1239	OG956	-6408	235.5
1240	OG957	-6426	125.5
1241	OG958	-6444	235.5
1242	OG959	-6462	125.5
1243	OG960	-6480	235.5
1244	OG961	-6498	125.5
1245	OG962	-6516	235.5
1246	OG963	-6534	125.5
1247	OG964	-6552	235.5
1248	OG965	-6570	125.5
1249	OG966	-6588	235.5
1250	OG967	-6606	125.5
1251	OG968	-6624	235.5
1252	OG969	-6642	125.5
1253	OG970	-6660	235.5
1254	OG971	-6678	125.5
1255	OG972	-6696	235.5
1256	OG973	-6714	125.5
1257	OG974	-6732	235.5
1258	OG975	-6750	125.5
1259	OG976	-6768	235.5
1260	OG977	-6786	125.5
1261	OG978	-6804	235.5
1262	OG979	-6822	125.5
1263	OG980	-6840	235.5
1264	OG981	-6858	125.5
1265	OG982	-6876	235.5
1266	OG983	-6894	125.5
1267	OG984	-6912	235.5
1268	OG985	-6930	125.5
1269	OG986	-6948	235.5



PAD No.	PAD Name	X	Y
1270	OG987	-6966	125.5
1271	OG988	-6984	235.5
1272	OG989	-7002	125.5
1273	OG990	-7020	235.5
1274	OG991	-7038	125.5
1275	OG992	-7056	235.5
1276	OG993	-7074	125.5
1277	OG994	-7092	235.5
1278	OG995	-7110	125.5
1279	OG996	-7128	235.5
1280	OG997	-7146	125.5
1281	OG998	-7164	235.5
1282	OG999	-7182	125.5
1283	OG1000	-7200	235.5
1284	OG1001	-7218	125.5
1285	OG1002	-7236	235.5
1286	OG1003	-7254	125.5
1287	OG1004	-7272	235.5
1288	OG1005	-7290	125.5
1289	OG1006	-7308	235.5
1290	OG1007	-7326	125.5
1291	OG1008	-7344	235.5
1292	OG1009	-7362	125.5
1293	OG1010	-7380	235.5
1294	OG1011	-7398	125.5
1295	OG1012	-7416	235.5
1296	OG1013	-7434	125.5
1297	OG1014	-7452	235.5
1298	OG1015	-7470	125.5
1299	OG1016	-7488	235.5
1300	OG1017	-7506	125.5
1301	OG1018	-7524	235.5
1302	OG1019	-7542	125.5
1303	OG1020	-7560	235.5
1304	OG1021	-7578	125.5
1305	OG1022	-7596	235.5
1306	OG1023	-7614	125.5
1307	OG1024	-7632	235.5
1308	OG1025	-7650	125.5
1309	OG1026	-7668	235.5
1310	OG1027	-7686	125.5
1311	OG1028	-7704	235.5
1312	OG1029	-7722	125.5
1313	OG1030	-7740	235.5
1314	OG1031	-7758	125.5
1315	OG1032	-7776	235.5
1316	OG1033	-7794	125.5
1317	OG1034	-7812	235.5
1318	OG1035	-7830	125.5
1319	OG1036	-7848	235.5
1320	OG1037	-7866	125.5
1321	OG1038	-7884	235.5
1322	OG1039	-7902	125.5

PAD No.	PAD Name	X	Y
1323	OG1040	-7920	235.5
1324	OG1041	-7938	125.5
1325	OG1042	-7956	235.5
1326	OG1043	-7974	125.5
1327	OG1044	-7992	235.5
1328	OG1045	-8010	125.5
1329	OG1046	-8028	235.5
1330	OG1047	-8046	125.5
1331	OG1048	-8064	235.5
1332	OG1049	-8082	125.5
1333	OG1050	-8100	235.5
1334	OG1051	-8118	125.5
1335	OG1052	-8136	235.5
1336	OG1053	-8154	125.5
1337	OG1054	-8172	235.5
1338	OG1055	-8190	125.5
1339	OG1056	-8208	235.5
1340	OG1057	-8226	125.5
1341	OG1058	-8244	235.5
1342	OG1059	-8262	125.5
1343	OG1060	-8280	235.5
1344	OG1061	-8298	125.5
1345	OG1062	-8316	235.5
1346	OG1063	-8334	125.5
1347	OG1064	-8352	235.5
1348	OG1065	-8370	125.5
1349	OG1066	-8388	235.5
1350	OG1067	-8406	125.5
1351	OG1068	-8424	235.5
1352	OG1069	-8442	125.5
1353	OG1070	-8460	235.5
1354	OG1071	-8478	125.5
1355	OG1072	-8496	235.5
1356	OG1073	-8514	125.5
1357	OG1074	-8532	235.5
1358	OG1075	-8550	125.5
1359	OG1076	-8568	235.5
1360	OG1077	-8586	125.5
1361	OG1078	-8604	235.5
1362	OG1079	-8622	125.5
1363	OG1080	-8640	235.5
1364	OG1081	-8658	125.5
1365	OG1082	-8676	235.5
1366	OG1083	-8694	125.5
1367	OG1084	-8712	235.5
1368	OG1085	-8730	125.5
1369	OG1086	-8748	235.5
1370	OG1087	-8766	125.5
1371	OG1088	-8784	235.5
1372	OG1089	-8802	125.5
1373	OG1090	-8820	235.5
1374	OG1091	-8838	125.5
1375	OG1092	-8856	235.5

PAD No.	PAD Name	X	Y
1376	OG1093	-8874	125.5
1377	OG1094	-8892	235.5
1378	OG1095	-8910	125.5
1379	OG1096	-8928	235.5
1380	OG1097	-8946	125.5
1381	OG1098	-8964	235.5
1382	OG1099	-8982	125.5
1383	OG1100	-9000	235.5
1384	OG1101	-9018	125.5
1385	OG1102	-9036	235.5
1386	OG1103	-9054	125.5
1387	OG1104	-9072	235.5
1388	OG1105	-9090	125.5
1389	OG1106	-9108	235.5
1390	OG1107	-9126	125.5
1391	OG1108	-9144	235.5
1392	OG1109	-9162	125.5
1393	OG1110	-9180	235.5
1394	OG1111	-9198	125.5
1395	OG1112	-9216	235.5
1396	OG1113	-9234	125.5
1397	OG1114	-9252	235.5
1398	OG1115	-9270	125.5
1399	OG1116	-9288	235.5
1400	OG1117	-9306	125.5
1401	OG1118	-9324	235.5
1402	OG1119	-9342	125.5
1403	OG1120	-9360	235.5
1404	OG1121	-9378	125.5
1405	OG1122	-9396	235.5
1406	OG1123	-9414	125.5
1407	OG1124	-9432	235.5
1408	OG1125	-9450	125.5
1409	OG1126	-9468	235.5
1410	OG1127	-9486	125.5
1411	OG1128	-9504	235.5
1412	OG1129	-9522	125.5
1413	OG1130	-9540	235.5
1414	OG1131	-9558	125.5
1415	OG1132	-9576	235.5
1416	OG1133	-9594	125.5
1417	OG1134	-9612	235.5
1418	OG1135	-9630	125.5
1419	OG1136	-9648	235.5
1420	OG1137	-9666	125.5
1421	OG1138	-9684	235.5
1422	OG1139	-9702	125.5
1423	OG1140	-9720	235.5
1424	OG1141	-9738	125.5
1425	OG1142	-9756	235.5
1426	OG1143	-9774	125.5
1427	OG1144	-9792	235.5
1428	OG1145	-9810	125.5

PAD No.	PAD Name	X	Y
1429	OG1146	-9828	235.5
1430	OG1147	-9846	125.5
1431	OG1148	-9864	235.5
1432	OG1149	-9882	125.5
1433	OG1150	-9900	235.5
1434	OG1151	-9918	125.5
1435	OG1152	-9936	235.5
1436	OG1153	-9954	125.5
1437	OG1154	-9972	235.5
1438	OG1155	-9990	125.5
1439	OG1156	-10008	235.5
1440	OG1157	-10026	125.5
1441	OG1158	-10044	235.5
1442	OG1159	-10062	125.5
1443	OG1160	-10080	235.5
1444	OG1161	-10098	125.5
1445	OG1162	-10116	235.5
1446	OG1163	-10134	125.5
1447	OG1164	-10152	235.5
1448	OG1165	-10170	125.5
1449	OG1166	-10188	235.5
1450	OG1167	-10206	125.5

PAD No.	PAD Name	X	Y
1451	OG1168	-10224	235.5
1452	OG1169	-10242	125.5
1453	OG1170	-10260	235.5
1454	OG1171	-10278	125.5
1455	OG1172	-10296	235.5
1456	OG1173	-10314	125.5
1457	OG1174	-10332	235.5
1458	OG1175	-10350	125.5
1459	OG1176	-10368	235.5
1460	OG1177	-10386	125.5
1461	OG1178	-10404	235.5
1462	OG1179	-10422	125.5
1463	OG1180	-10440	235.5
1464	OG1181	-10458	125.5
1465	OG1182	-10476	235.5
1466	OG1183	-10494	125.5
1467	OG1184	-10512	235.5
1468	OG1185	-10530	125.5
1469	OG1186	-10548	235.5
1470	OG1187	-10566	125.5
1471	OG1188	-10584	235.5
1472	OG1189	-10602	125.5

PAD No.	PAD Name	X	Y
1473	OG1190	-10620	235.5
1474	OG1191	-10638	125.5
1475	OG1192	-10656	235.5
1476	OG1193	-10674	125.5
1477	OG1194	-10692	235.5
1478	OG1195	-10710	125.5
1479	OG1196	-10728	235.5
1480	OG1197	-10746	125.5
1481	OG1198	-10764	235.5
1482	OG1199	-10782	125.5
1483	OG1200	-10800	235.5
1484	VGL	-10818	125.5
1485	DUM222	-10836	235.5
1486	IN_XON	-11283	262
1487	IN_XON	-11373	262
1488	IN_F_CTRL	-11463	262
1489	IN_F_CTRL	-11553	262
1490	IN_OE3	-11643	156
1491	IN_OE2	-11643	208
1492	IN_OE1	-11643	262
1493	IN_OE1	-11733	262

#### 9.4. Alignment Mark

--Alignment Mark coordinate

Left (-11101.5, 220.5)

Right (11101.5, 220.5)

--Alignment Mark size

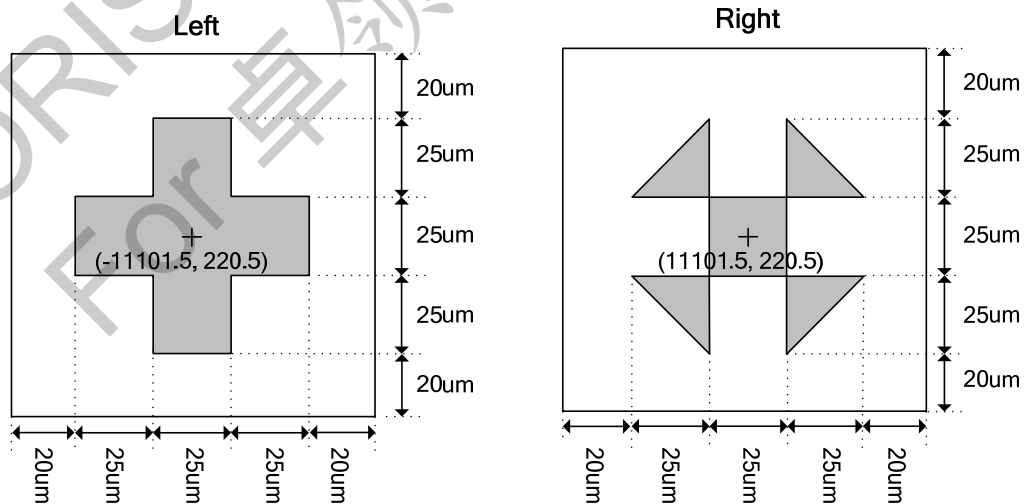



## 10. DISCLAIMER

The information appearing in this publication is believed to be accurate.

Integrated circuits sold by ORISE Technology are covered by the warranty and patent indemnification provisions stipulated in the terms of sale only. ORISE Technology makes no warranty, express, statutory implied or by description regarding the information in this publication or regarding the freedom of the described chip(s) from patent infringement. FURTHERMORE, ORISE Technology MAKES NO WARRANTY OF MERCHANTABILITY OR FITNESS FOR ANY PURPOSE. ORISE Technology reserves the right to halt production or alter the specifications and prices at any time without notice. Accordingly, the reader is cautioned to verify that the data sheets and other information in this publication are current before placing orders. Products described herein are intended for use in normal commercial applications. Applications involving unusual environmental or reliability requirements, e.g. military equipment or medical life support equipment, are specifically not recommended without additional processing by ORISE Technology for such applications. Please note that application circuits illustrated in this document are for reference purposes only.

ORISE Tech Confidential  
For 卓領科技 Use Only

## 11. REVISION HISTORY

Date	Revision #	Description	Page	Auditor
DEC. 19, 2011	0.8	1. Modify Recommended Operating Conditions	12	Hung-Jen Chien
		2. Modify AC Characteristics	13	
		3. Add timing waveform	13	
		4. Add chip thickness 300 um (OTD9120A-C3)	14	
MAY. 03, 2011	0.7	1. Update ORDERING INFORMATION.	3, 14	Hung-Jen Chien
		2. Update Pin Assignment.	8	
OCT. 15, 2010	0.6	Update Pad Assignment.	13	Hung-Jen Chien
JUN. 17, 2010	0.5	1. Add Ordering information.	3	Hung-Jen Chien
		2. Update Chip thickness.	14	
JUN. 14, 2010	0.4	Modify Chip size.	13	Hung-Jen Chien
MAY. 25, 2010	0.3	1. Update Block Diagram	3-5	Hung-Jen Chien
		2. Update Setting of Output-Sequence-Control Pin		
FEB. 01, 2010	0.2	1. Add Pin Assignment.	7	Hung-Jen Chien
		2. Update Pad Assignment.	13	
OCT. 20, 2009	0.1	Original	24	Hung-Jen Chien