

# P0460ATF(S)

## N-Channel Enhancement Mode MOSFET

### PRODUCT SUMMARY

$V_{(BR)DSS}$	$R_{DS(ON)}$	$I_D$
600V	$2\Omega @ V_{GS} = 10V$	4A

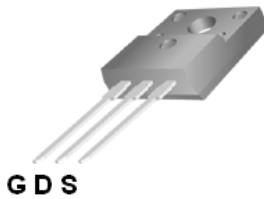

TO-220F  
TO-220FS

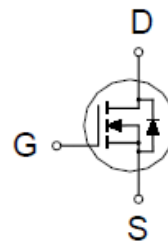

100% UIS tested

### ABSOLUTE MAXIMUM RATINGS ( $T_A = 25\text{ }^\circ\text{C}$ Unless Otherwise Noted)

PARAMETERS/TEST CONDITIONS		SYMBOL	LIMITS	UNITS
Drain-Source Voltage		$V_{DS}$	600	V
Gate-Source Voltage		$V_{GS}$	$\pm 30$	
Continuous Drain Current <sup>2</sup>	$T_C = 25\text{ }^\circ\text{C}$	$I_D$	4	A
	$T_C = 100\text{ }^\circ\text{C}$		2.5	
Pulsed Drain Current <sup>1,2</sup>		$I_{DM}$	20	
Avalanche Energy <sup>3</sup>		$E_{AS}$	20	mJ
Power Dissipation	$T_C = 25\text{ }^\circ\text{C}$	$P_D$	27	W
	$T_C = 100\text{ }^\circ\text{C}$		11	
Operating Junction & Storage Temperature Range		$T_J, T_{STG}$	-55 to 150	$^\circ\text{C}$

### THERMAL RESISTANCE RATINGS

THERMAL RESISTANCE	SYMBOL	TYPICAL	MAXIMUM	UNITS
Junction-to-Case	$R_{\theta JC}$		4.5	$^\circ\text{C} / \text{W}$
Junction-to-Ambient	$R_{\theta JA}$		62.5	

<sup>1</sup>Pulse width limited by maximum junction temperature.

<sup>2</sup>Limited only by maximum temperature allowed .

<sup>3</sup> $V_{DD} = 50V, L=10mH$ , starting  $T_J = 25^\circ\text{C}$

# P0460ATF(S)

## N-Channel Enhancement Mode MOSFET

### ELECTRICAL CHARACTERISTICS (T<sub>J</sub> = 25 °C, Unless Otherwise Noted)

PARAMETER	SYMBOL	TEST CONDITIONS	LIMITS			UNIT
			MIN	TYP	MAX	
<b>STATIC</b>						
Drain-Source Breakdown Voltage	V <sub>(BR)DSS</sub>	V <sub>GS</sub> = 0V, I <sub>D</sub> = 250μA	600			V
Gate Threshold Voltage	V <sub>GS(th)</sub>	V <sub>DS</sub> = V <sub>GS</sub> , I <sub>D</sub> = 250μA	2.5		4.5	V
Gate-Body Leakage	I <sub>GSS</sub>	V <sub>DS</sub> = 0V, V <sub>GS</sub> = ±30V			±100	nA
Gate Voltage Drain Current	I <sub>DSS</sub>	V <sub>DS</sub> = 600V, V <sub>GS</sub> = 0V, T <sub>C</sub> = 25 °C			25	μA
		V <sub>DS</sub> = 600V, V <sub>GS</sub> = 0V, T <sub>C</sub> = 100 °C			250	
Drain-Source On-State Resistance <sup>1</sup>	R <sub>DS(ON)</sub>	V <sub>GS</sub> = 10V, I <sub>D</sub> = 2A		1.85	2	Ω
Forward Transconductance <sup>1</sup>	g <sub>fs</sub>	V <sub>DS</sub> = 15V, I <sub>D</sub> = 2A		5		S
<b>DYNAMIC</b>						
Input Capacitance	C <sub>iss</sub>	V <sub>GS</sub> = 0V, V <sub>DS</sub> = 25V, f = 1MHz		780		pF
Output Capacitance	C <sub>oss</sub>			56		
Reverse Transfer Capacitance	C <sub>rss</sub>			12		
Total Gate Charge <sup>2</sup>	Q <sub>g</sub>	V <sub>DD</sub> = 300V, I <sub>D</sub> = 4A, V <sub>GS</sub> = 10V		19.4		nC
Gate-Source Charge <sup>2</sup>	Q <sub>gs</sub>			4.3		
Gate-Drain Charge <sup>2</sup>	Q <sub>gd</sub>			8.7		
Turn-On Delay Time <sup>2</sup>	t <sub>d(on)</sub>	V <sub>DD</sub> = 300V, I <sub>D</sub> = 4A, R <sub>G</sub> = 25Ω		23		nS
Rise Time <sup>2</sup>	t <sub>r</sub>			28		
Turn-Off Delay Time <sup>2</sup>	t <sub>d(off)</sub>			44		
Fall Time <sup>2</sup>	t <sub>f</sub>			44		
<b>SOURCE-DRAIN DIODE RATINGS AND CHARACTERISTICS (T<sub>J</sub> = 25 °C)</b>						
Continuous Current <sup>3</sup>	I <sub>S</sub>				4	A
Forward Voltage <sup>1</sup>	V <sub>SD</sub>	I <sub>F</sub> = 2A, V <sub>GS</sub> = 0V			1.5	V
Reverse Recovery Time	t <sub>rr</sub>	I <sub>F</sub> = 10A, di <sub>F</sub> /dt = 100A / μS,		324		nS
Reverse Recovery Charge	Q <sub>rr</sub>	V <sub>GS</sub> = 0V		2.4		nC

<sup>1</sup>Pulse test : Pulse Width ≤ 300 μsec, Duty Cycle ≤ 2%.

<sup>2</sup>Independent of operating temperature.

<sup>3</sup>Pulse width limited by maximum junction temperature.

# P0460ATF(S)

## N-Channel Enhancement Mode MOSFET

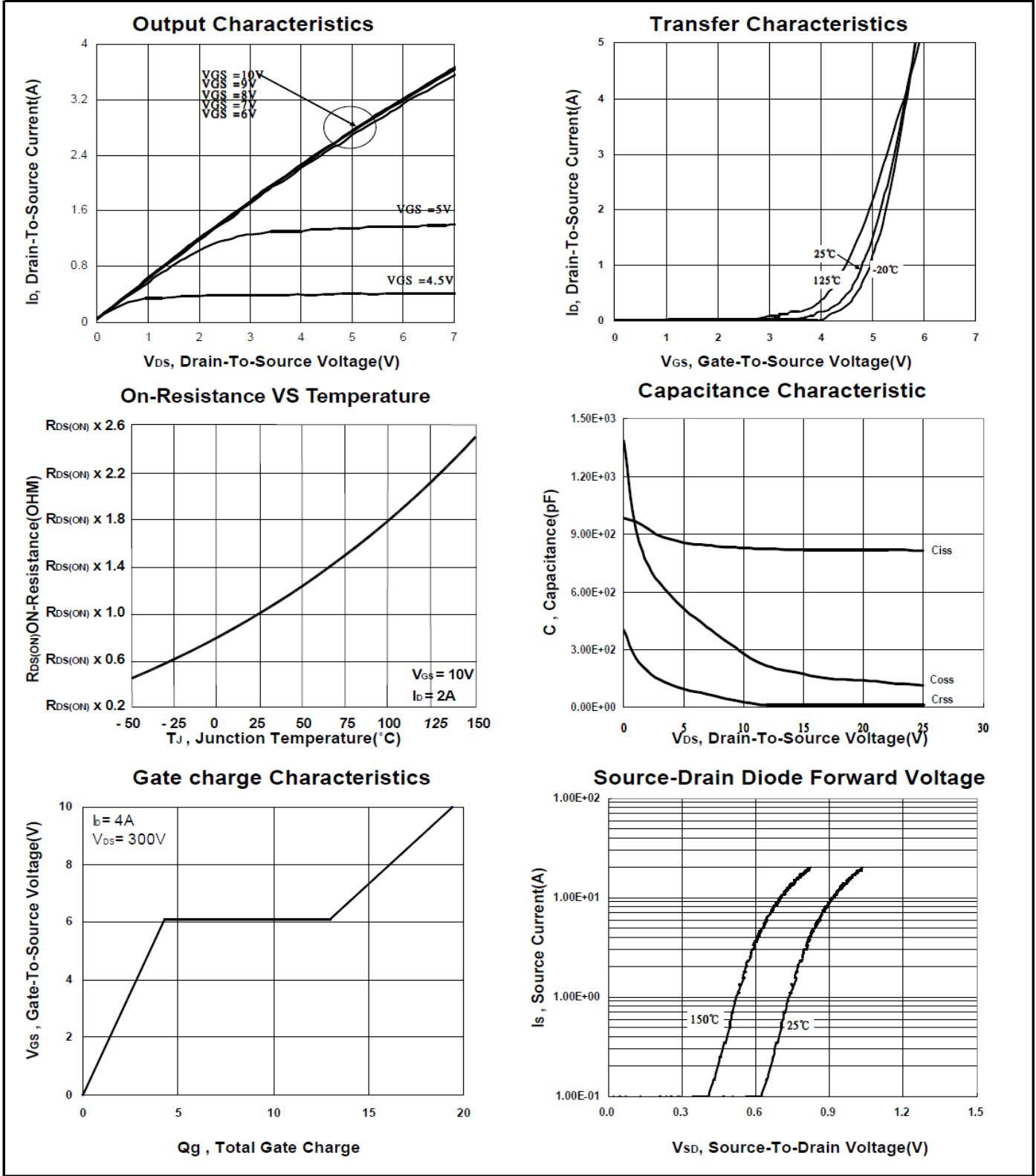

# P0460ATF(S)

## N-Channel Enhancement Mode MOSFET

**Safe Operating Area**

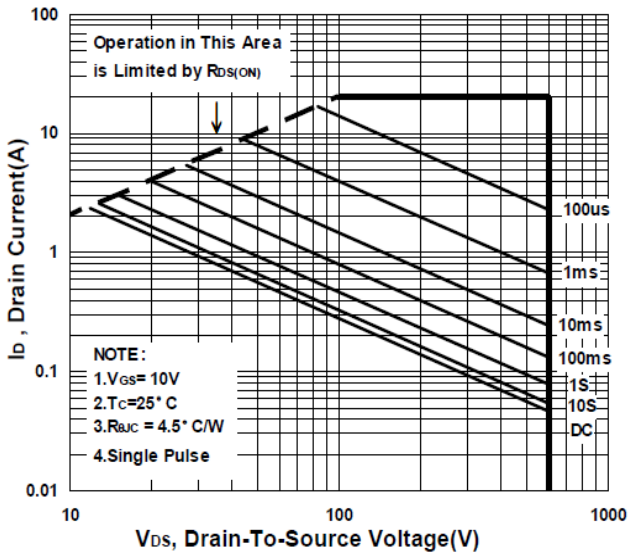

**Single Pulse Maximum Power Dissipation**

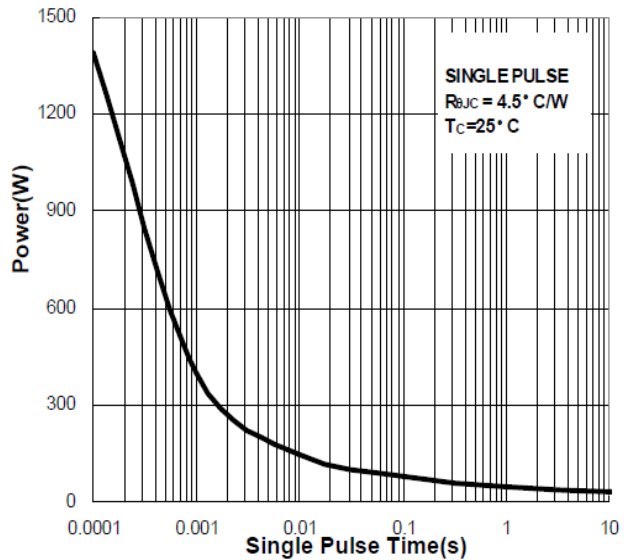

**Transient Thermal Response Curve**

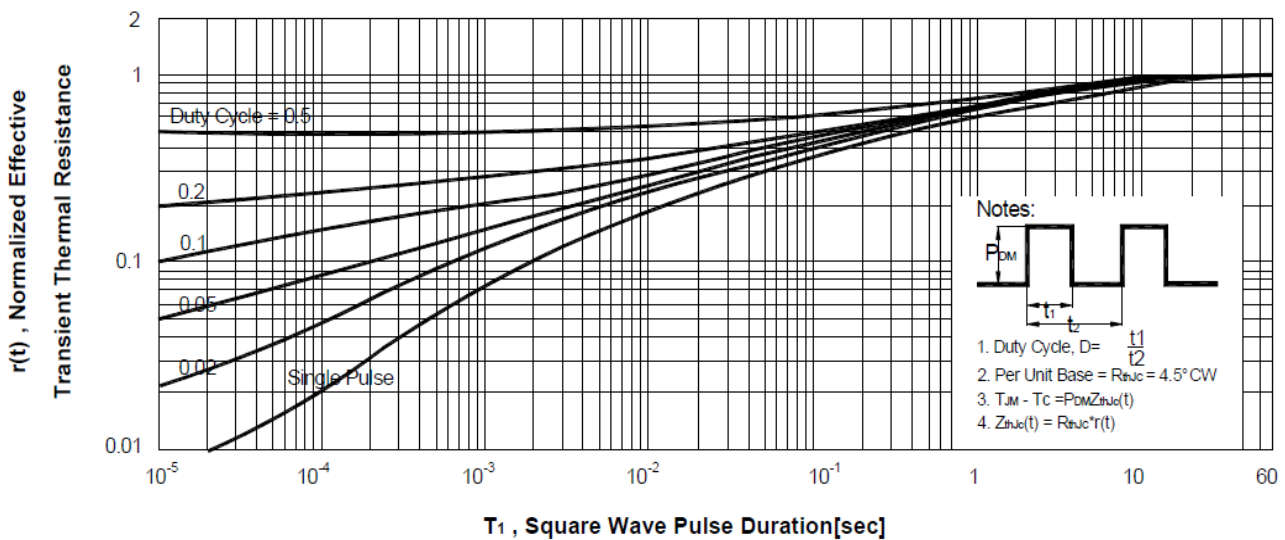

# P0460ATF(S)

## N-Channel Enhancement Mode MOSFET

### Package Dimension

### TO-220F (3-Lead) MECHANICAL DATA

Dimension	mm			Dimension	mm		
	Min.	Typ.	Max.		Min.	Typ.	Max.
A	4.2		4.93	e	2.05	2.55	3.05
A1	2.34		3.1	F	27.45		30.6
B	17.77		20.3	G	7.72		9.3
b	0.6		1.05	H	6.1		7.1
b1	0.9	1.23	1.62	L	12.5		14.5
b2	0.6		1.9	L1	1.97		3.8
c	0.4		1.0	P	2.98		3.4
D	14.7		16.4	Q	2.1		2.96
D1	6.4		7.5	q	3.0		3.8
E	9.7		10.4				

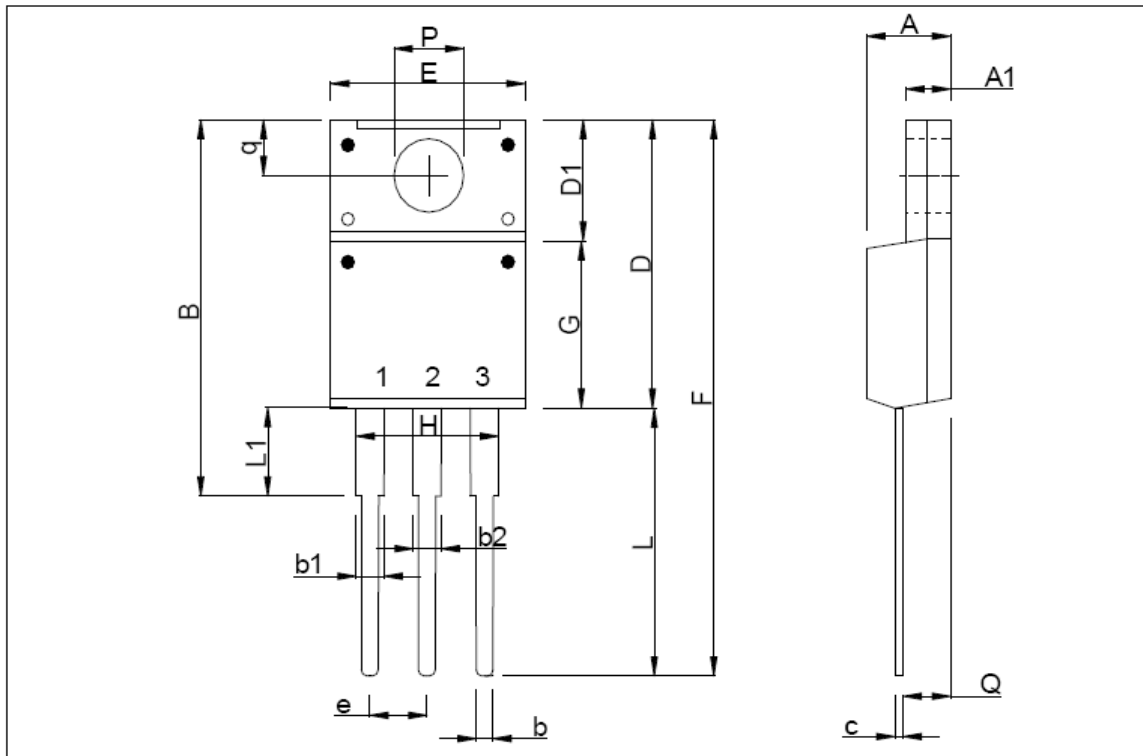

# P0460ATF(S)

## N-Channel Enhancement Mode MOSFET

### Package Dimension

### TO-220FS (3-Lead) MECHANICAL DATA

Dimension	mm			Dimension	mm		
	Min.	Typ.	Max.		Min.	Typ.	Max.
A	4.2	4.7	4.93	e	2.05	2.54	3.05
A1	2.34	2.8	3.1	F	28.04		30.3
B	17.7		20.3	G	8.2	8.87	9.57
b	0.65	0.8	1.05	L	12.37		14.3
b1	0.9	1.3	1.5	L1	1.4	2.3	2.5
c	0.4	0.7	1.0	P	2.98	3.2	3.4
D	15.37		16.3	Q	2.1	2.6	2.96
D1	5.5		7.5	q	3.0	3.5	3.8
E	9.7	10.16	10.36				

