

P0460BTF / P046BTFS

N-Channel Enhancement Mode MOSFET

PRODUCT SUMMARY

$V_{(BR)DSS}$	$R_{DS(ON)}$	I_D
600V	$2.6\Omega @ V_{GS} = 10V$	4A

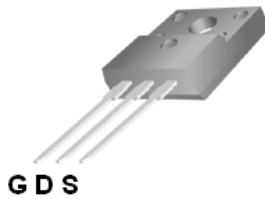

TO-220F
TO-220FS

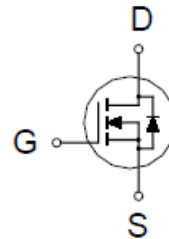

100% UIS tested

ABSOLUTE MAXIMUM RATINGS ($T_A = 25\text{ }^\circ\text{C}$ Unless Otherwise Noted)

PARAMETERS/TEST CONDITIONS		SYMBOL	LIMITS	UNITS
Drain-Source Voltage		V_{DS}	600	V
Gate-Source Voltage		V_{GS}	± 30	
Continuous Drain Current ²	$T_C = 25\text{ }^\circ\text{C}$	I_D	4	A
	$T_C = 100\text{ }^\circ\text{C}$		1.5	
Pulsed Drain Current ¹		I_{DM}	16	
Avalanche Current		I_{AS}	4	
Avalanche Energy	$L = 10\text{mH}$	E_{AS}	81	mJ
Power Dissipation	$T_C = 25\text{ }^\circ\text{C}$	P_D	25	W
	$T_C = 100\text{ }^\circ\text{C}$		10	
Operating Junction & Storage Temperature Range		T_J, T_{STG}	-55 to 150	$^\circ\text{C}$

THERMAL RESISTANCE RATINGS

THERMAL RESISTANCE	SYMBOL	TYPICAL	MAXIMUM	UNITS
Junction-to-Case	$R_{\theta JC}$		5	$^\circ\text{C} / \text{W}$
Junction-to-Ambient	$R_{\theta JA}$		62.5	

¹Pulse width limited by maximum junction temperature.

²Limited by package.

P0460BTF / P046BTFS

N-Channel Enhancement Mode MOSFET

ELECTRICAL CHARACTERISTICS (T_J = 25 °C, Unless Otherwise Noted)

PARAMETER	SYMBOL	TEST CONDITIONS	LIMITS			UNIT
			MIN	TYP	MAX	
STATIC						
Drain-Source Breakdown Voltage	V _{(BR)DSS}	V _{GS} = 0V, I _D = 250μA	600			V
Gate Threshold Voltage	V _{GS(th)}	V _{DS} = V _{GS} , I _D = 250μA	2.5	3.5	4.5	
Gate-Body Leakage	I _{GSS}	V _{DS} = 0V, V _{GS} = ±30V			±100	nA
Gate Voltage Drain Current	I _{DSS}	V _{DS} = 600V, V _{GS} = 0V, T _J = 25 °C			1	μA
		V _{DS} = 480V, V _{GS} = 0V, T _J = 125 °C			10	
Drain-Source On-State	R _{DS(ON)}	V _{GS} = 10V, I _D = 2A			2.6	Ω
Forward Transconductance ¹	g _{fs}	V _{DS} = 10V, I _D = 2A		3		S
DYNAMIC						
Input Capacitance	C _{iss}	V _{GS} = 0V, V _{DS} = 25V, f = 1MHz		623		pF
Output Capacitance	C _{oss}			98		
Reverse Transfer Capacitance	C _{rss}			24		
Turn-On Delay Time ²	t _{d(on)}	V _{DD} = 300V, I _D = 4A, R _G = 6Ω		15		nS
Rise Time ²	t _r			47		
Turn-Off Delay Time ²	t _{d(off)}			45		
Fall Time ²	t _f			56		
SOURCE-DRAIN DIODE RATINGS AND CHARACTERISTICS (T_J = 25 °C)						
Continuous Current	I _S				15	A
Forward Voltage ¹	V _{SD}	I _F = 4A, V _{GS} = 0V			1.6	V
Reverse Recovery Time	t _{rr}	I _F = 4A, dI _F /dt = 100A / μS		322		nS
Reverse Recovery Charge	Q _{rr}				3.2	

¹Pulse test : Pulse Width ≤ 300 μsec, Duty Cycle ≤ 2%.

²Independent of operating temperature.

P0460BTF / P046BTFS

N-Channel Enhancement Mode MOSFET

Output Characteristics

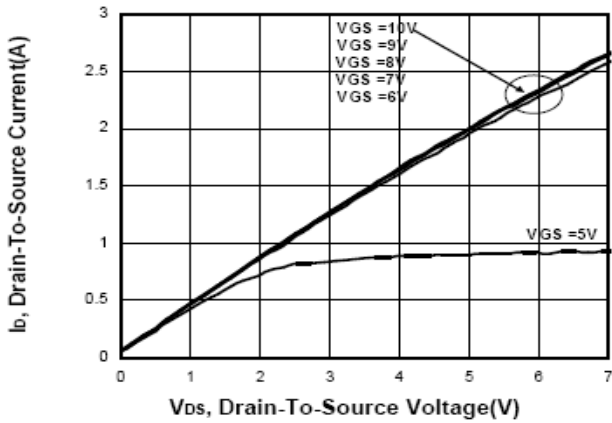

Transfer Characteristics

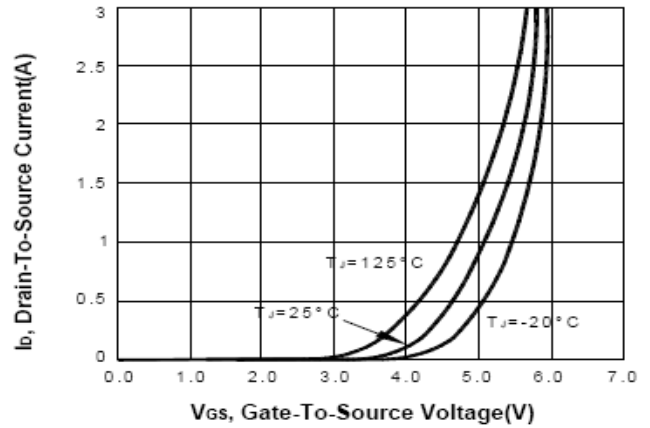

On-Resistance VS Temperature

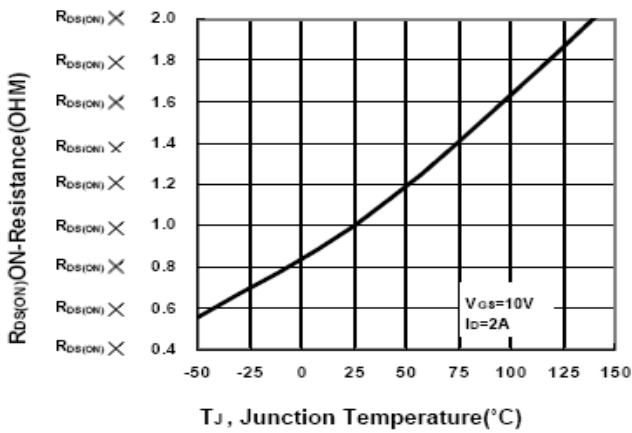

Capacitance Characteristic

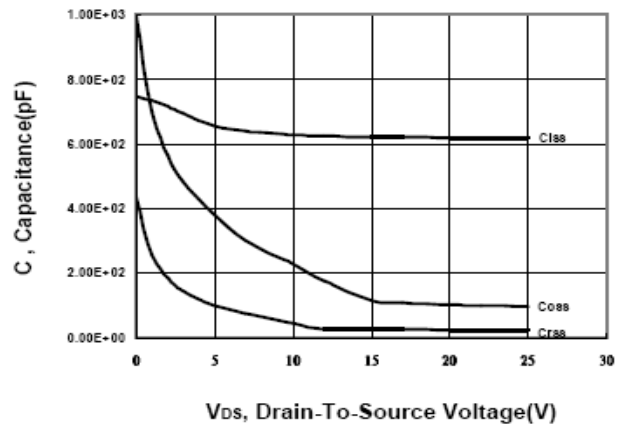

Source-Drain Diode Forward Voltage

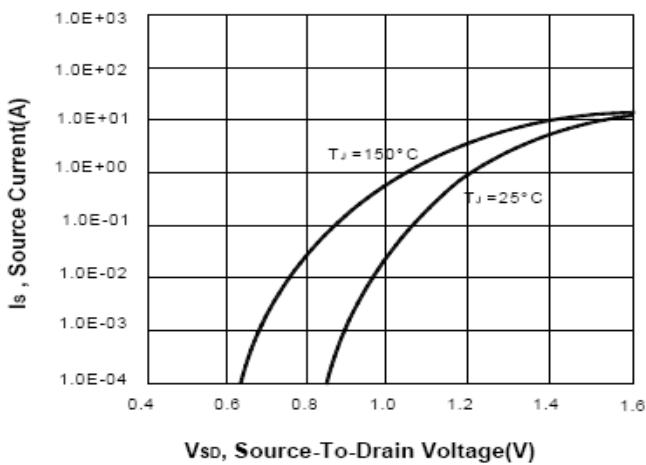

P0460BTF / P046BTFS

N-Channel Enhancement Mode MOSFET

Safe Operating Area

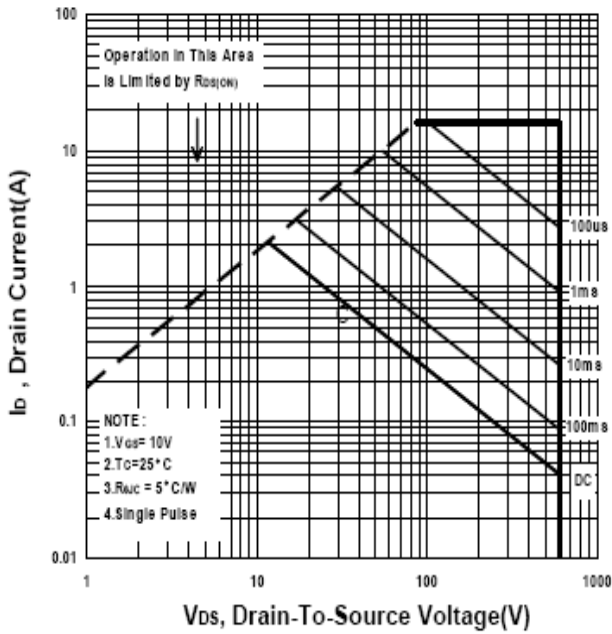

Single Pulse Maximum Power Dissipation

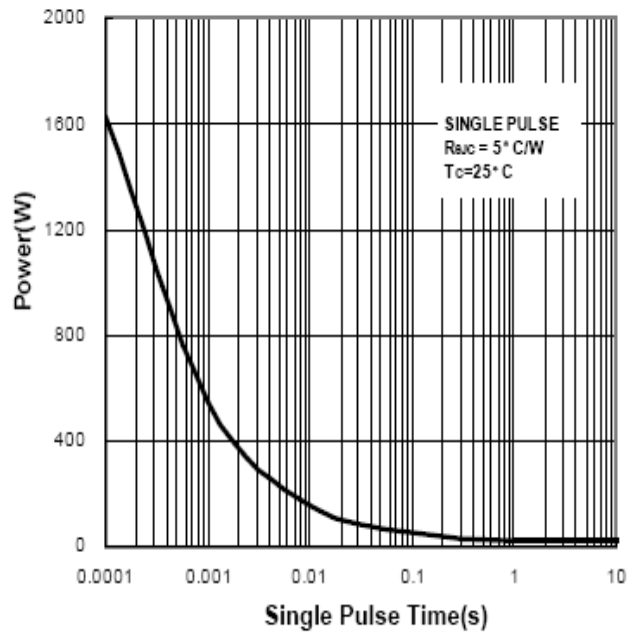

Transient Thermal Response Curve

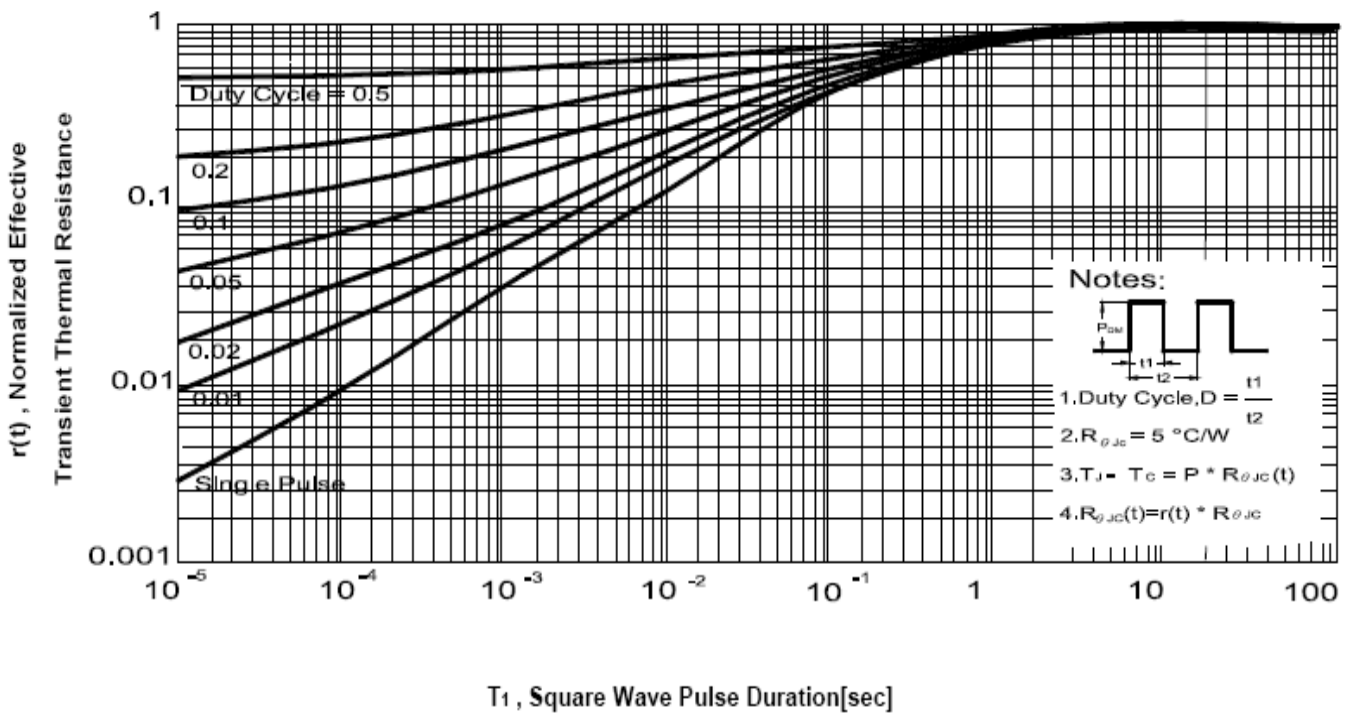

P0460BTF / P046BTFS

N-Channel Enhancement Mode MOSFET

Package Dimension

TO-220F (3-Lead) MECHANICAL DATA

Dimension	mm			Dimension	mm		
	Min.	Typ.	Max.		Min.	Typ.	Max.
A	4.2		4.93	e	2.05	2.55	3.05
A1	2.34		3.1	F	27.45		30.6
B	17.77		20.3	G	7.72		9.3
b	0.6		1.05	H	6.1		7.1
b1	0.9	1.23	1.62	L	12.5		14.5
b2	0.6		1.9	L1	1.97		3.8
c	0.4		1.0	P	2.98		3.4
D	14.7		16.4	Q	2.1		2.96
D1	6.4		7.5	q	3.0		3.8
E	9.7		10.4				

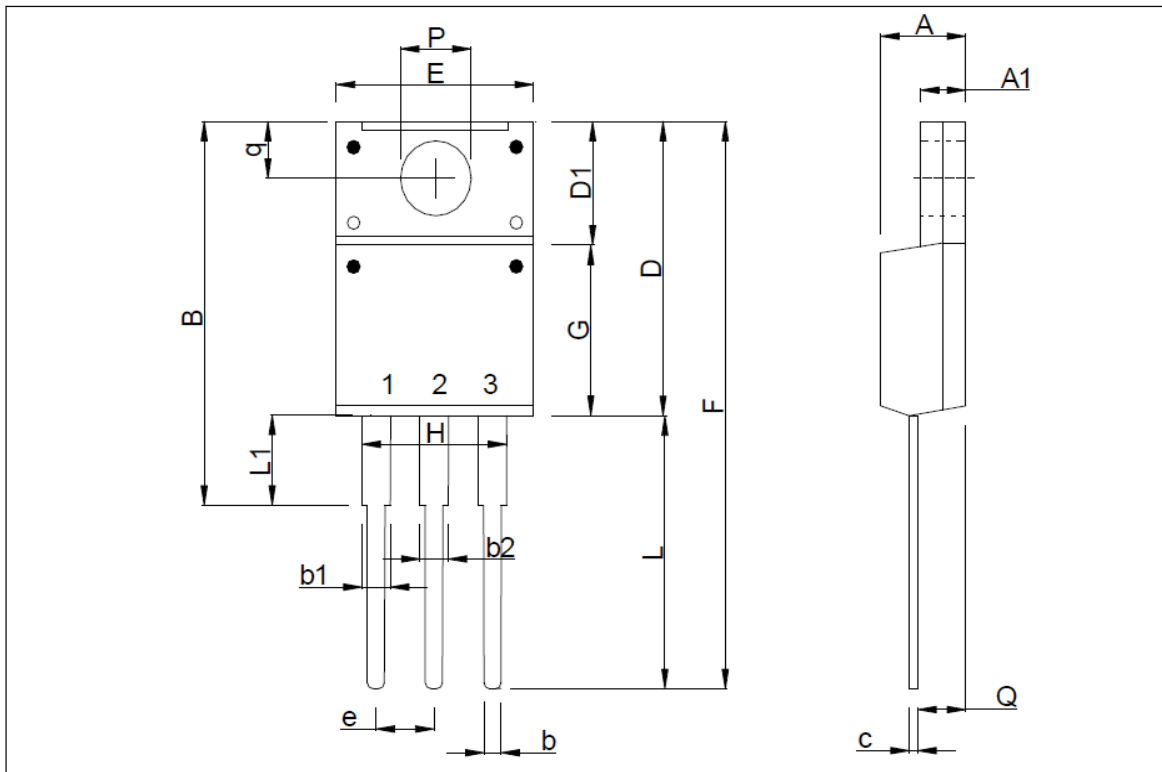

P0460BTF / P046BTFS

N-Channel Enhancement Mode MOSFET

Package Dimension

TO-220FS (3-Lead) MECHANICAL DATA

Dimension	mm			Dimension	mm		
	Min.	Typ.	Max.		Min.	Typ.	Max.
A	4.2	4.7	4.93	e	2.05	2.54	3.05
A1	2.34	2.8	3.1	F	28.04		30.3
B	17.7		20.3	G	8.2	8.87	9.57
b	0.65	0.8	1.05	L	12.37		14.3
b1	0.9	1.3	1.5	L1	1.4	2.3	2.5
c	0.4	0.7	1.0	P	2.98	3.2	3.4
D	15.37		16.3	Q	2.1	2.6	2.96
D1	5.5		7.5	q	3.0	3.5	3.8
E	9.7	10.16	10.36				

