

P0465ATF / P0465ATFS

N-Channel Enhancement Mode MOSFET

PRODUCT SUMMARY

$V_{(BR)DSS}$	$R_{DS(ON)}$	I_D
650V	2.5Ω @ $V_{GS} = 10V$	4A

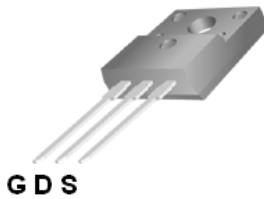

TO-220F
TO-220FS

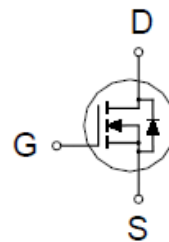

ABSOLUTE MAXIMUM RATINGS ($T_A = 25\text{ °C}$ Unless Otherwise Noted)

PARAMETERS/TEST CONDITIONS		SYMBOL	LIMITS	UNITS
Drain-Source Voltage		V_{DS}	650	V
Gate-Source Voltage		V_{GS}	±30	
Continuous Drain Current ²	$T_C = 25\text{ °C}$	I_D	4	A
	$T_C = 100\text{ °C}$		2.2	
Pulsed Drain Current ^{1,2}		I_{DM}	16	
Avalanche Energy ³		E_{AS}	23.8	mJ
Power Dissipation	$T_C = 25\text{ °C}$	P_D	25	W
	$T_C = 100\text{ °C}$		10	
Operating Junction & Storage Temperature Range		T_J, T_{STG}	-55 to 150	°C

THERMAL RESISTANCE RATINGS

THERMAL RESISTANCE	SYMBOL	TYPICAL	MAXIMUM	UNITS
Junction-to-Case	$R_{\theta JC}$		5	°C / W
Junction-to-Ambient	$R_{\theta JA}$		62.5	

¹Pulse width limited by maximum junction temperature.

²Limited only by maximum temperature allowed.

³ $V_{DD}=50V, L=10mH, \text{starting } T_J=25\text{ °C}$

P0465ATF / P0465ATFS

N-Channel Enhancement Mode MOSFET

ELECTRICAL CHARACTERISTICS (T_J = 25 °C, Unless Otherwise Noted)

PARAMETER	SYMBOL	TEST CONDITIONS	LIMITS			UNIT
			MIN	TYP	MAX	
STATIC						
Drain-Source Breakdown Voltage	V _{(BR)DSS}	V _{GS} = 0V, I _D = 250μA	650			V
Gate Threshold Voltage	V _{GS(th)}	V _{DS} = V _{GS} , I _D = 10μA	2	3	4	
Gate Threshold Voltage	V _{GS(th)}	V _{DS} = V _{GS} , I _D = 250μA	2.5	3.4	4.5	
Gate-Body Leakage	I _{GSS}	V _{DS} = 0V, V _{GS} = ±30V			±100	nA
Gate Voltage Drain Current	I _{DSS}	V _{DS} = 650V, V _{GS} = 0V, T _C = 25 °C			25	μA
		V _{DS} = 520V, V _{GS} = 0V, T _C = 100 °C			250	
Drain-Source On-State Resistance ¹	R _{DS(ON)}	V _{GS} = 10V, I _D = 2A			2.5	Ω
Forward Transconductance ¹	g _{fs}	V _{DS} = 25V, I _D = 2A		3.8		S
DYNAMIC						
Input Capacitance	C _{iss}	V _{GS} = 0V, V _{DS} = 25V, f = 1MHz		828		pF
Output Capacitance	C _{oss}			69		
Reverse Transfer Capacitance	C _{rss}			3		
Gate Resistance	R _g	V _{DS} = 0V, V _{GS} = 0V, f=1MHz		1.95		Ω
Total Gate Charge ²	Q _g	V _{DD} = 520V, I _D = 4A, V _{GS} = 10V		14		nC
Gate-Source Charge ²	Q _{gs}			4		
Gate-Drain Charge ²	Q _{gd}			3		
Turn-On Delay Time ²	t _{d(on)}	V _{DD} = 325V, I _D = 4A, R _G = 25Ω		35		nS
Rise Time ²	t _r			80		
Turn-Off Delay Time ²	t _{d(off)}			140		
Fall Time ²	t _f			84		
SOURCE-DRAIN DIODE RATINGS AND CHARACTERISTICS (T_J = 25 °C)						
Continuous Current ³	I _S				4	A
Forward Voltage ¹	V _{SD}	I _F = 4A, V _{GS} = 0V			1.5	V
Reverse Recovery Time	t _{rr}	I _F = 4A, di _F /dt = 100A / μS		364		nS
Reverse Recovery Charge	Q _{rr}			3.3		μC

¹Pulse test : Pulse Width ≤ 300 μsec, Duty Cycle ≤ 2%.

²Independent of operating temperature.

³Pulse width limited by maximum junction temperature.

P0465ATF / P0465ATFS

N-Channel Enhancement Mode MOSFET

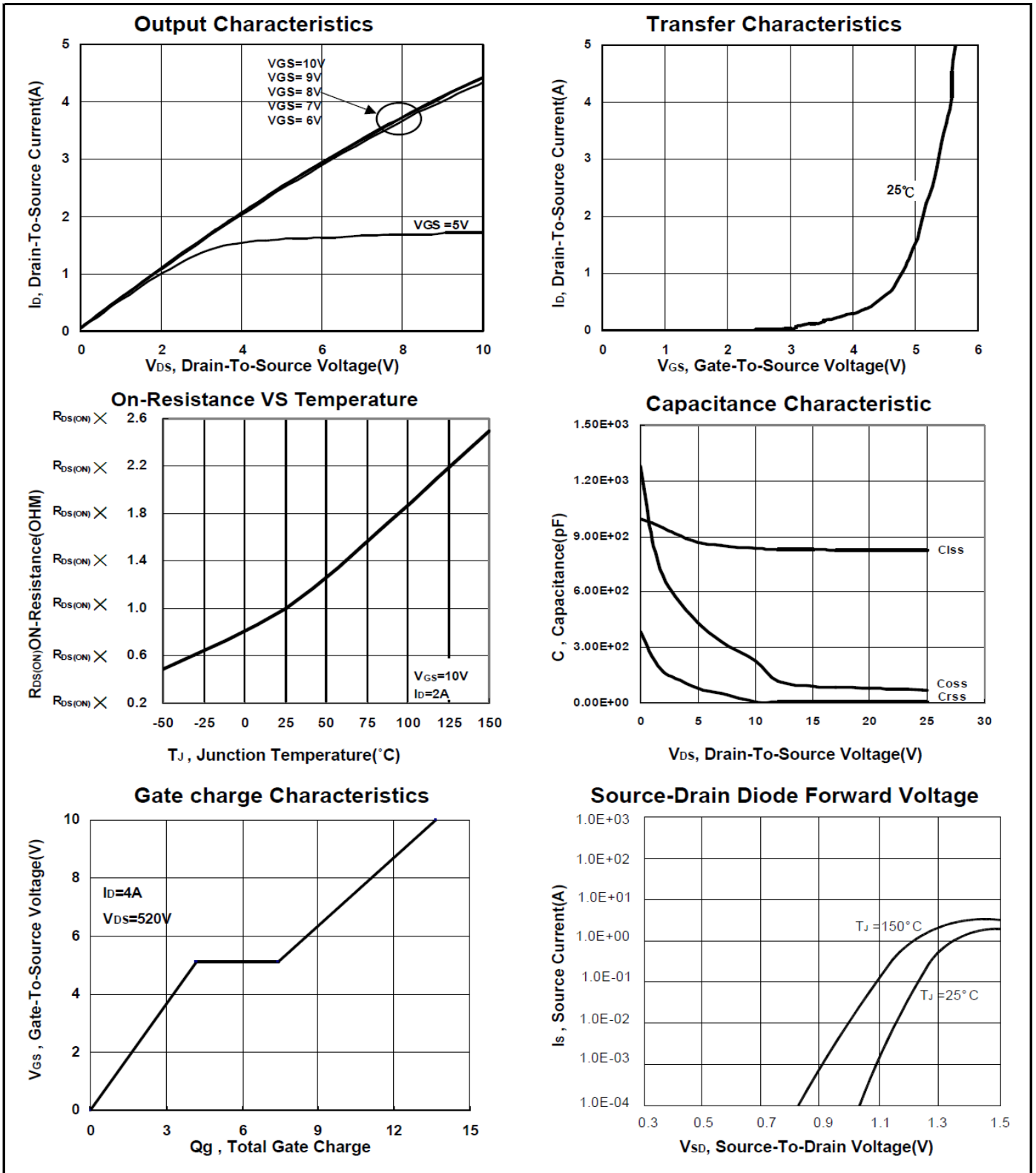

P0465ATF / P0465ATFS

N-Channel Enhancement Mode MOSFET

Safe Operating Area

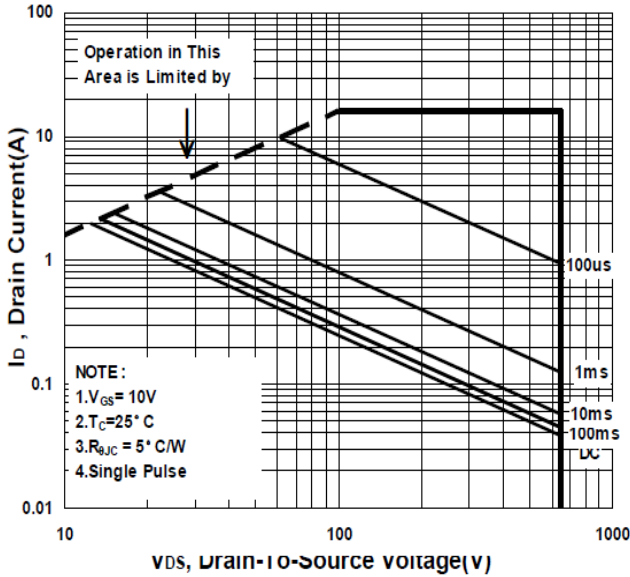

Single Pulse Maximum Power Dissipation

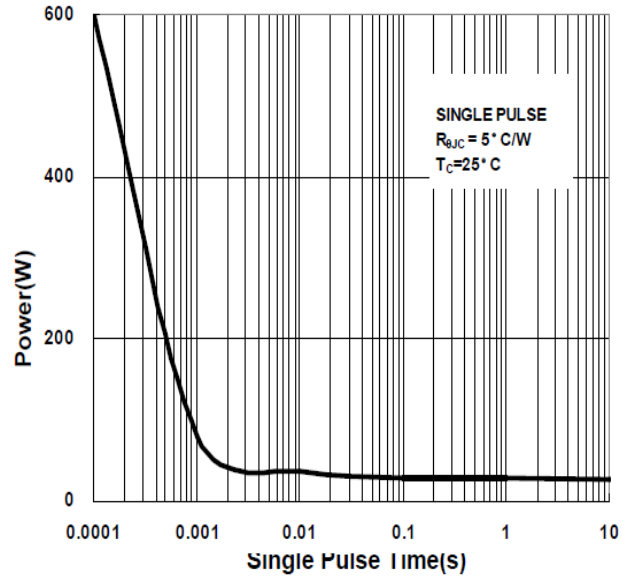

Transient Thermal Response Curve

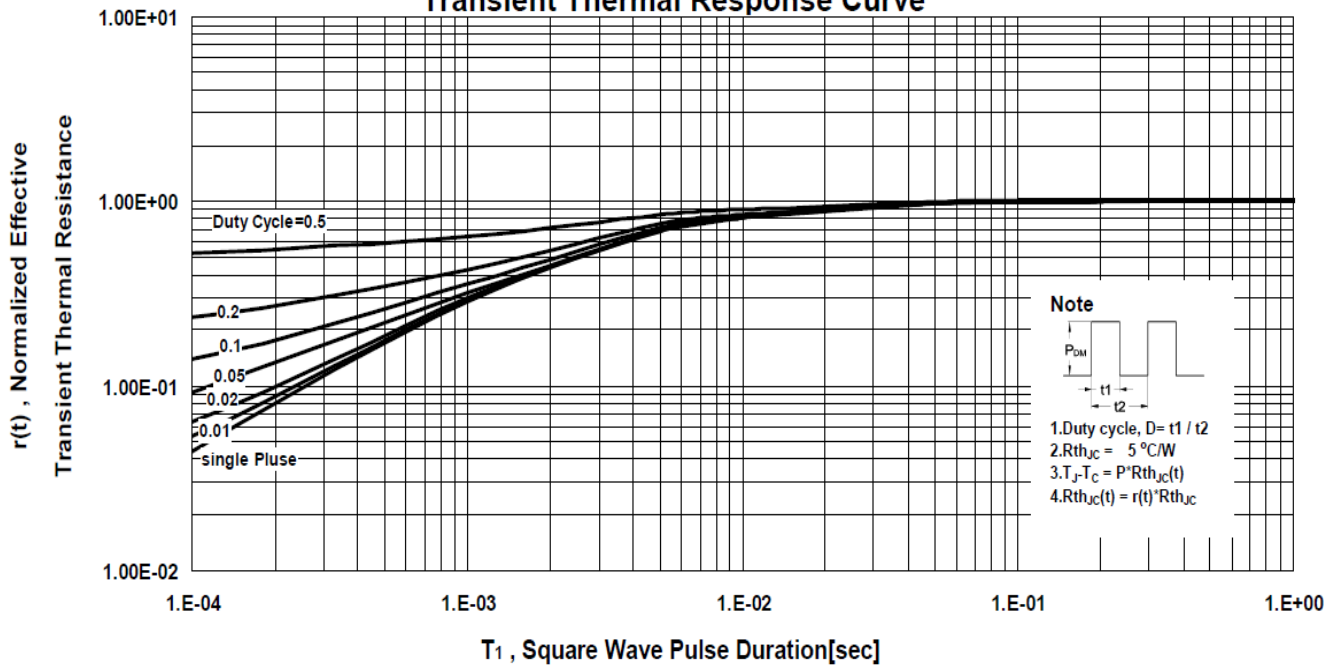

P0465ATF / P0465ATFS

N-Channel Enhancement Mode MOSFET

Package Dimension

TO-220F (3-Lead) MECHANICAL DATA

Dimension	mm			Dimension	mm		
	Min.	Typ.	Max.		Min.	Typ.	Max.
A	4.2		4.93	e	2.05	2.55	3.05
A1	2.34		3.1	F	27.45		30.6
B	17.77		20.3	G	7.72		9.3
b	0.6		1.05	H	6.1		7.1
b1	0.9	1.23	1.62	L	12.5		14.5
b2	0.6		1.9	L1	1.97		3.8
c	0.4		1.0	P	2.98		3.4
D	14.7		16.4	Q	2.1		2.96
D1	6.4		7.5	q	3.0		3.8
E	9.7		10.4				

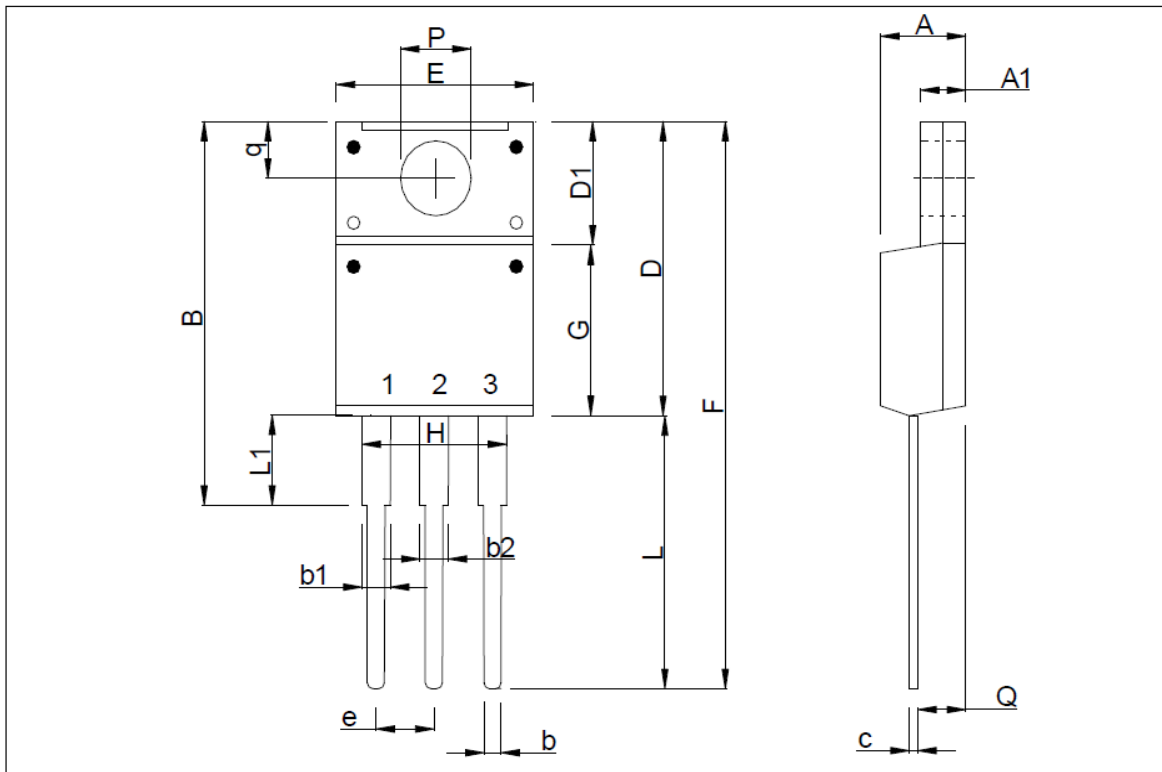

P0465ATF / P0465ATFS

N-Channel Enhancement Mode MOSFET

Package Dimension

TO-220FS (3-Lead) MECHANICAL DATA

Dimension	mm			Dimension	mm		
	Min.	Typ.	Max.		Min.	Typ.	Max.
A	4.2	4.7	4.93	e	2.05	2.54	3.05
A1	2.34	2.8	3.1	F	28.04		30.3
B	17.7		20.3	G	8.2	8.87	9.57
b	0.65	0.8	1.05	L	12.37		14.3
b1	0.9	1.3	1.5	L1	1.4	2.3	2.5
c	0.4	0.7	1.0	P	2.98	3.2	3.4
D	15.37		16.3	Q	2.1	2.6	2.96
D1	5.5		7.5	q	3.0	3.5	3.8
E	9.7	10.16	10.36				

