

HF RoHS Fixed Voltage TwinSLIC™ Series - Modified DO-214



Description

Fixed Voltage Series Modified DO-214 are uni-directional SIDACTor® devices designed to protect SLICs (Subscriber Line Interface Circuit) from damaging overvoltage transients.

The series provides single port protection using fixed voltage switching devices for negative surges. All positive surges are routed through internal diodes to a ground reference.

Features and Benefits

- Low voltage overshoot
- Low on-state voltage
- Does not degrade with use
- Fails short circuit when surged in excess of ratings
- Integrated diodes for positive voltage surges
- Single-port protection

Agency Approvals

Agency	Agency File Number
	E133083

Pinout Designation

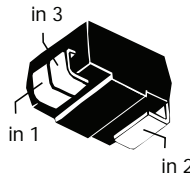

Applicable Global Standards

- TIA-968-A
- TIA-968-B
- ITU K.20/21 Enhanced Level
- ITU K.20/21 Basic Level
- GR 1089 Inter-building*
- GR 1089 Intra-building*
- IEC 61000-4-5
- YD/T 1082
- YD/T 993
- YD/T 950

* Series resistance required

Schematic Symbol

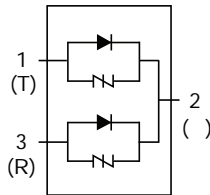

Electrical Characteristics

Part Number	Marking	V_{DRM}	V_S	I_H	I_S	I_T	V_T	V_F	Capacitance
		@ $I_{DRM} = 5\mu A$	@ $100V/\mu s$				@ $I_T = 2.2$ Amps		
		V min	V max	mA min	mA max	A max	V max	V max	
		Pin 1-2, 3-2							
P0641CA2LRP	P62A	58	77	120	800	2.2	4	5	See Capacitance Values table
P0721CA2LRP	P72A	65	88	120	800	2.2	4	5	
P0901CA2LRP	P92A	75	98	120	800	2.2	4	5	
P1101CA2LRP	P02A	95	130	120	800	2.2	4	5	
P1301CA2LRP	P131A	120	160	120	800	2.2	4	5	
P1701CA2LRP	P17A	160	200	120	800	2.2	4	5	

Notes:
 - Absolute maximum ratings measured at $T_A = 25^\circ C$ (unless otherwise noted).
 - Devices are uni-directional

Capacitance Values

Part Number	pF Pin 1-2 / 3-2 Tip-Ground, Ring-Ground		pF Pin 1-3 Tip-Ring	
	MIN	MAX	MIN	MAX
	P0641CA2LRP	40	70	20
P0721CA2LRP	35	70	20	45
P0901CA2LRP	30	65	20	40
P1101CA2LRP	25	55	15	35
P1301CA2LRP	25	45	15	30
P1701CA2LRP	25	40	15	25

Note: Off-state capacitance (C_o) is measured at 1 MHz with a 2 V bias.

Surge Ratings

Series	I_{PP}									I_{TSM} 50/60 Hz	di/dt
	0.2x310 ¹ 0.5x700 ²	2x10 ¹ 2x10 ²	8x20 ¹ 1.2x50 ²	10x160 ¹ 10x160 ²	10x560 ¹ 10x560 ²	5x320 ¹ 9x720 ²	10x360 ¹ 10x360 ²	10x1000 ¹ 10x1000 ²	5x310 ¹ 10x700 ²		
	A min	A min	A min	A min	A min	A min	A min	A min	A min		
A	20	150	150	90	50	75	75	45	75	20	500

Notes:

- Peak pulse current rating (I_{pp}) is repetitive and guaranteed for the life of the product.
- I_{pp} ratings applicable over temperature range of -40°C to +85°C
- The device must initially be in thermal equilibrium with -40°C ≤ T_j ≤ +150°C

- 1 Current waveform in μ s
- 2 Voltage waveform in μ s

Thermal Considerations

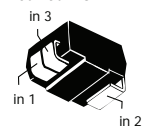
Package	Symbol	Parameter	Value	Unit
Modified DO-214AA 	T_j	Operating Junction Temperature Range	-40 to +150	°C
	T_s	Storage Temperature Range	-65 to +150	°C
	$R_{\theta JA}$	Thermal Resistance: Junction to Ambient	85	°C/W

V-I Characteristics

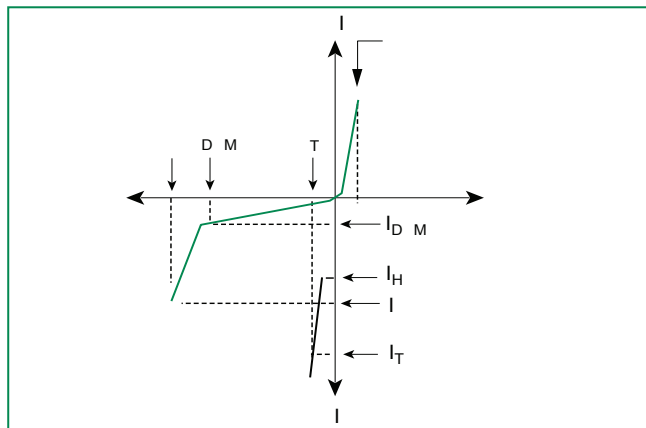

$t_r \times t_d$ Pulse Waveform

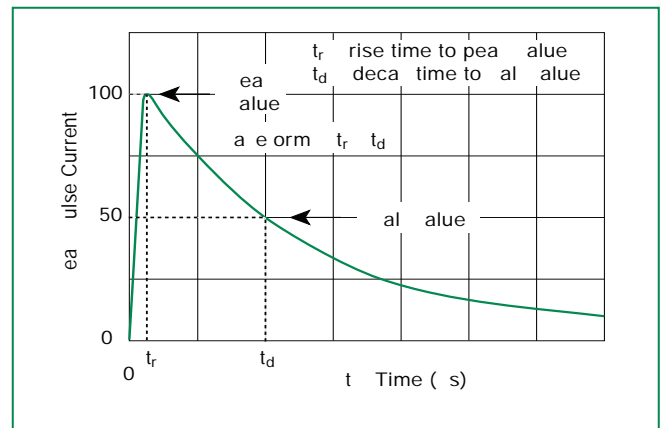

Normalized V_s Change vs. Junction Temperature

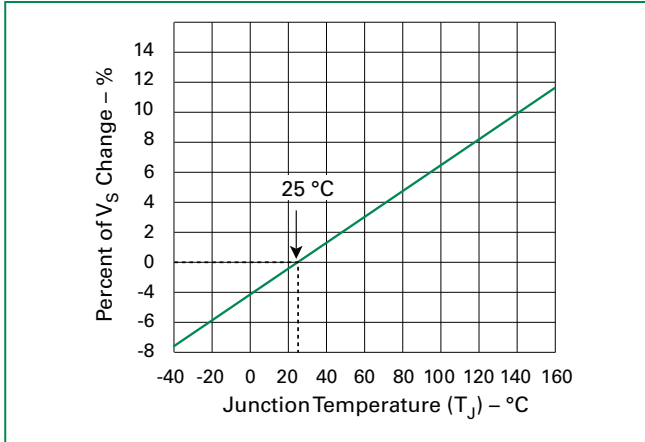

Normalized DC Holding Current vs. Case Temperature

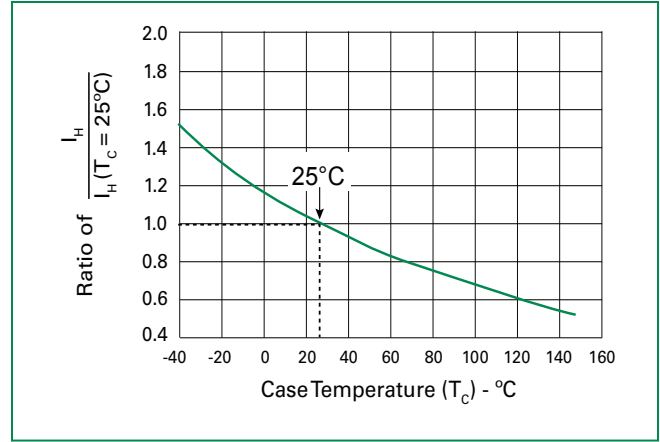

Soldering Parameters

Reflow Condition		Pb-Free assembly (see Fig. 1)
Pre Heat	-Temperature Min ($T_{s(\min)}$)	+150°C
	-Temperature Max ($T_{s(\max)}$)	+200°C
	-Time (Min to Max) (t_s)	60-180 secs.
Average ramp up rate (Liquidus Temp (T_L) to peak)		3°C/sec. Max.
$T_{s(\max)}$ to T_L - Ramp-up Rate		3°C/sec. Max.
Reflow	-Temperature (T_L) (Liquidus)	+217°C
	-Temperature (t_L)	60-150 secs.
Peak Temp (T_p)		+260(+0/-5)°C
Time within 5°C of actual Peak Temp (t_p)		30 secs. Max.
Ramp-down Rate		6°C/sec. Max.
Time 25°C to Peak Temp (T_p)		8 min. Max.
Do not exceed		+260°C

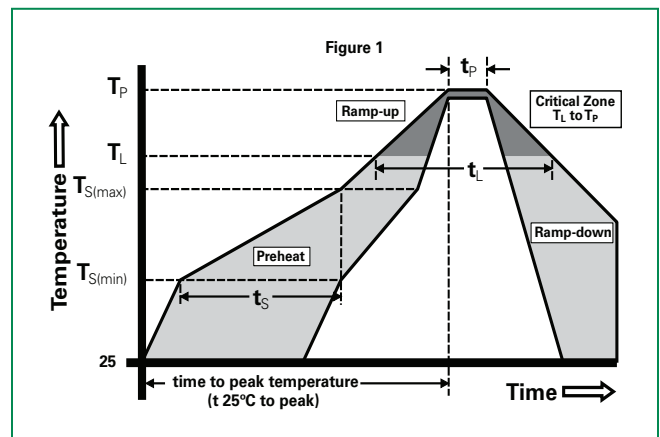

Physical Specifications

Lead Material	Copper Alloy
Terminal Finish	100% Matte-Tin Plated
Body Material	UL recognized epoxy meeting flammability classification 94V-0

Environmental Specifications

High Temp Voltage Blocking	80% Rated V_{DRM} (V_{AC} Peak) +125°C or +150°C, 504 or 1008 hrs. MIL-STD-750 (Method 1040) JEDEC, JESD22-A-101
Temp Cycling	-65°C to +150°C, 15 min. dwell, 10 up to 100 cycles. MIL-STD-750 (Method 1051) EIA/JEDEC, JESD22-A104
Biased Temp & Humidity	52 V_{DC} (+85°C) 85%RH, 504 up to 1008 hrs. EIA/JEDEC, JESD22-A-101
High Temp Storage	+150°C 1008 hrs. MIL-STD-750 (Method 1031) JEDEC, JESD22-A-101
Low Temp Storage	-65°C, 1008 hrs.
Thermal Shock	0°C to +100°C, 5 min. dwell, 10 sec. transfer, 10 cycles. MIL-STD-750 (Method 1056) JEDEC, JESD22-A-106
Autoclave (Pressure Cooker Test)	+121°C, 100%RH, 2atm, 24 up to 168 hrs. EIA/JEDEC, JESD22-A-102
Resistance to Solder Heat	+260°C, 30 secs. MIL-STD-750 (Method 2031)
Moisture Sensitivity Level	85%RH, +85°C, 168 hrs., 3 reflow cycles (+260°C peak). JEDEC-J-STD-020, Level 1

Part Numbering

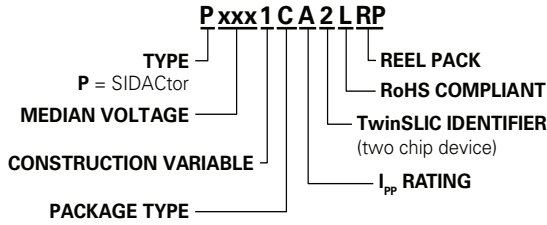

Part Marking

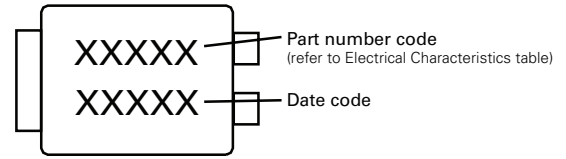

Dimensions — Modified DO-214AA

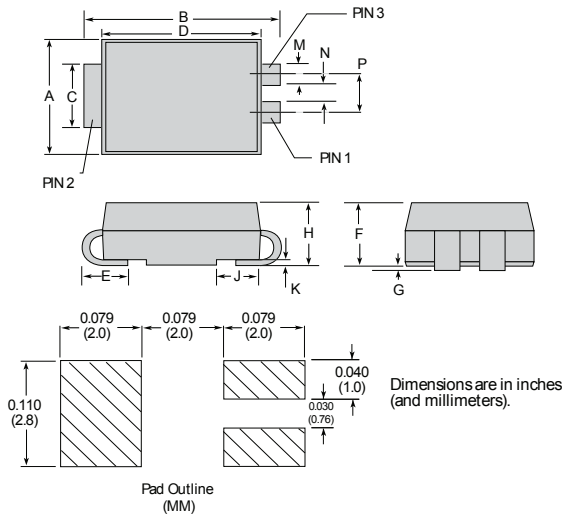

Dimensions	Inches		Millimeters	
	Min	Max	Min	Max
A	0.130	0.156	3.30	3.95
B	0.201	0.220	5.10	5.60
C	0.077	0.087	1.95	2.20
D	0.159	0.181	4.05	4.60
E	0.030	0.063	0.75	1.60
F	0.075	0.096	1.90	2.45
G	0.002	0.008	0.05	0.20
H	0.077	0.104	1.95	2.65
K	0.006	0.016	0.15	0.41
M	0.022	0.028	0.56	0.71
N	0.027	0.033	0.69	0.84
P	0.052	0.058	1.32	1.47

Packing Options

Package Type	Description	Quantity	Added Suffix	Industry Standard
C	Modified DO-214AA 3-leaded Tape and Reel Pack	2500	RP	EIA-481-D

Tape and Reel Specification — Modified DO-214AA

