

**PRODUCT SUMMARY**

$V_{(BR)DSS}$	$R_{DS(ON)}$	$I_D$
40V	10mΩ	55A

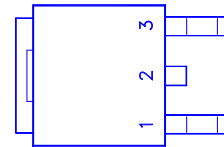
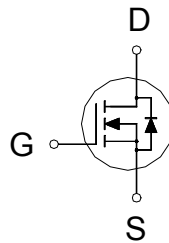

1. GATE
2. DRAIN
3. SOURCE

100% Rg tested  
100% UIS tested

**ABSOLUTE MAXIMUM RATINGS ( $T_A = 25\text{ °C}$  Unless Otherwise Noted)**

PARAMETERS/TEST CONDITIONS		SYMBOL	LIMITS	UNITS
Drain-Source Voltage		$V_{DS}$	40	V
Gate-Source Voltage		$V_{GS}$	±20	V
Continuous Drain Current	$T_C = 25\text{ °C}$	$I_D$	55	A
	$T_C = 70\text{ °C}$		44	
Pulsed Drain Current <sup>1</sup>		$I_{DM}$	120	
Avalanche Current		$I_{AS}$	38	
Avalanche Energy <sup>2</sup>	L = 0.1mH	$E_{AS}$	73	mJ
Power Dissipation	$T_C = 25\text{ °C}$	$P_D$	50	W
	$T_C = 70\text{ °C}$		32	
Junction & Storage Temperature Range		$T_J, T_{stg}$	-55 to 150	°C

**THERMAL RESISTANCE RATINGS**

THERMAL RESISTANCE	SYMBOL	TYPICAL	MAXIMUM	UNITS
Junction-to-Ambient	$R_{\theta JA}$		62.5	°C / W
Junction-to-Case	$R_{\theta JC}$		2.5	

<sup>1</sup>Pulse width limited by maximum junction temperature.

<sup>2</sup> $V_{DD} = 20V$  . Starting  $T_J = 25\text{ °C}$ .

**ELECTRICAL CHARACTERISTICS ( $T_J = 25\text{ °C}$ , Unless Otherwise Noted)**

PARAMETER	SYMBOL	TEST CONDITIONS	LIMITS			UNIT
			MIN	TYP	MAX	
<b>STATIC</b>						
Drain-Source Breakdown Voltage	$V_{(BR)DSS}$	$V_{GS} = 0V, I_D = 250\mu A$	40			V
Gate Threshold Voltage	$V_{GS(th)}$	$V_{DS} = V_{GS}, I_D = 250\mu A$	1.7	2.0	3.0	V
Gate-Body Leakage	$I_{GSS}$	$V_{DS} = 0V, V_{GS} = \pm 20V$			±100	nA
Zero Gate Voltage Drain Current	$I_{DSS}$	$V_{DS} = 32V, V_{GS} = 0V$			1	μA
		$V_{DS} = 30V, V_{GS} = 0V, T_J = 55\text{ °C}$			10	

Drain-Source On-State Resistance <sup>1</sup>	$R_{DS(ON)}$	$V_{GS} = 5V, I_D = 8A$	13	17	mΩ
		$V_{GS} = 10V, I_D = 15A$	8	10	
Forward Transconductance <sup>1</sup>	$g_{fs}$	$V_{DS} = 10V, I_D = 20A$	25		S
On-State Drain Current <sup>1</sup>	$I_{D(ON)}$	$V_{DS} = 10V, V_{GS} = 10V,$	120		A
<b>DYNAMIC</b>					
Input Capacitance	$C_{iss}$	$V_{GS} = 0V, V_{DS} = 20V, f = 1MHz$	1550	1750	pF
Output Capacitance	$C_{oss}$		280	310	
Reverse Transfer Capacitance	$C_{rss}$		185	200	
Gate Resistance	$R_g$	$V_{GS} = 15mV, V_{DS} = 0V, f = 1MHz$	1.5	2.5	Ω
Total Gate Charge <sup>2</sup>	$Q_g$	$V_{DS} = 0.5V_{(BR)DSS}, V_{GS} = 10V,$ $I_D = 20A$	26	32	nC
Gate-Source Charge <sup>2</sup>	$Q_{gs}$		6	8.5	
Gate-Drain Charge <sup>2</sup>	$Q_{gd}$		8	10	
Turn-On Delay Time <sup>2</sup>	$t_{d(on)}$	$V_{DS} = 20V, R_L = 1Ω$ $I_D ≅ 20A, V_{GS} = 10V, R_{GEN} = 6Ω$	12	33	nS
Rise Time <sup>2</sup>	$t_r$		35	65	
Turn-Off Delay Time <sup>2</sup>	$t_{d(off)}$		37		
Fall Time <sup>2</sup>	$t_f$		12	23	
<b>SOURCE-DRAIN DIODE RATINGS AND CHARACTERISTICS (T<sub>J</sub> = 25 °C)</b>					
Continuous Current	$I_S$			38	A
Forward Voltage <sup>1</sup>	$V_{SD}$	$I_F = 15A, V_{GS} = 0V$	0.7	1.3	V
Reverse Recovery Time	$t_{rr}$	$I_F = 20A, di_F/dt = 100A / μS$	75		nS
Reverse Recovery Charge	$Q_{rr}$		55		nC

<sup>1</sup>Pulse test : Pulse Width ≤ 300 μsec, Duty Cycle ≤ 2%.

<sup>2</sup>Independent of operating temperature.

**REMARK: THE PRODUCT MARKED WITH “P1004BD”, DATE CODE or LOT #**

Output Characteristics

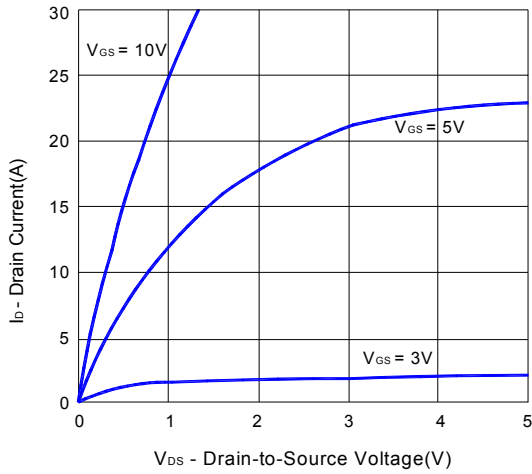

Transfer Characteristics

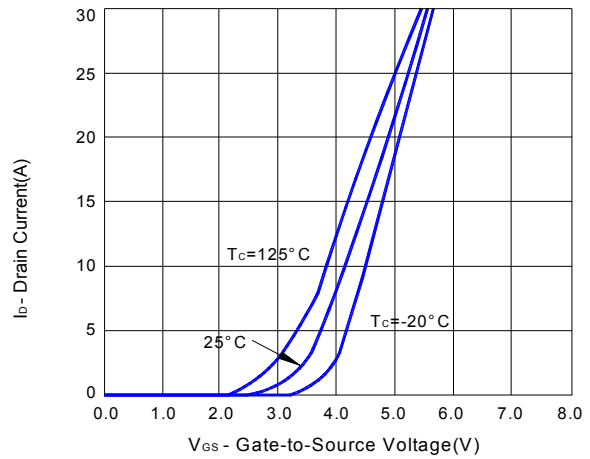

On-Resistance vs. Drain Current

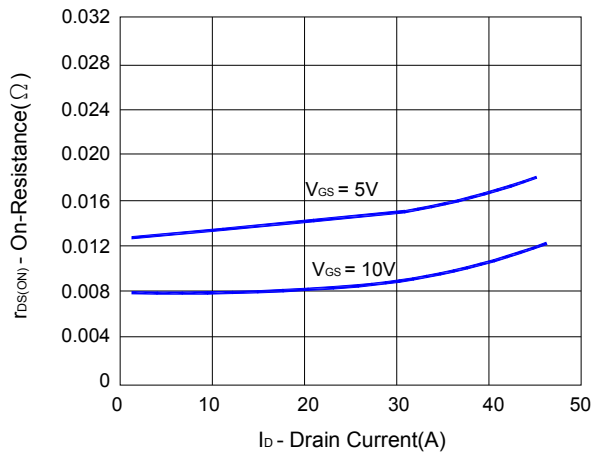

Capacitance

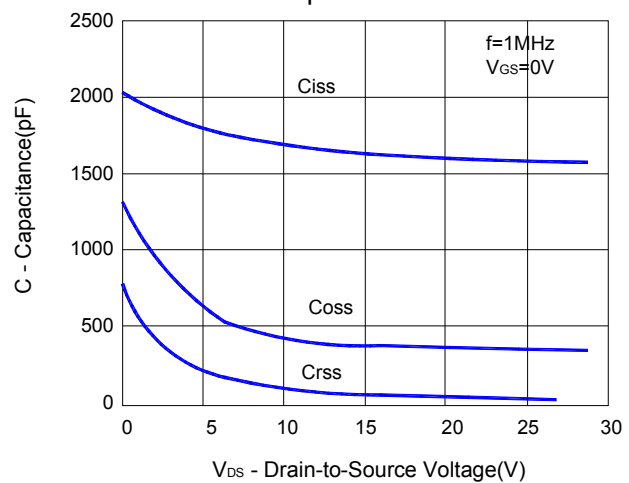

Gate Charge

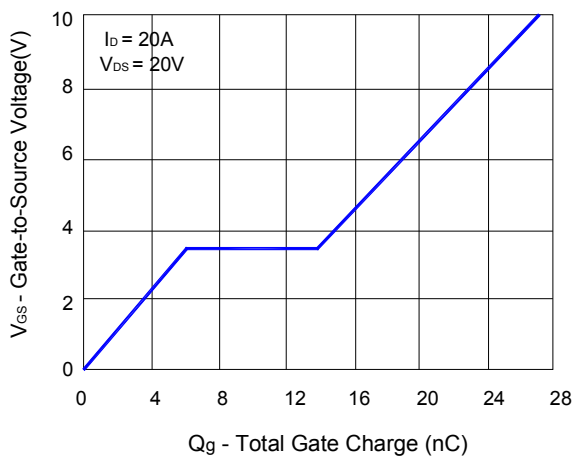

On-Resistance vs. Junction Temperature

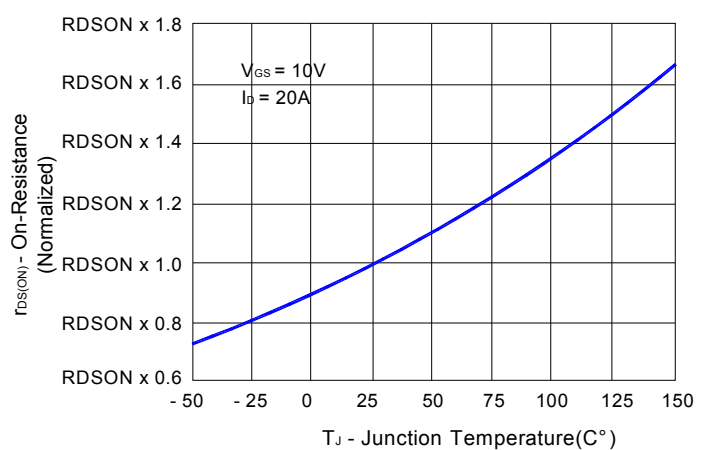

Source - Drain Diode Forward Voltage

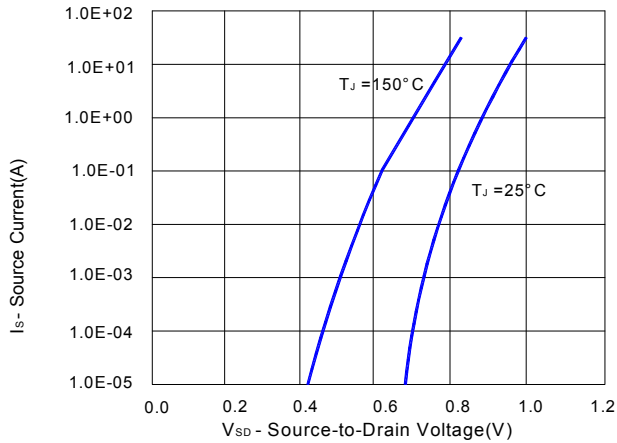

On-Resistance vs. Gate-to-Source Voltage

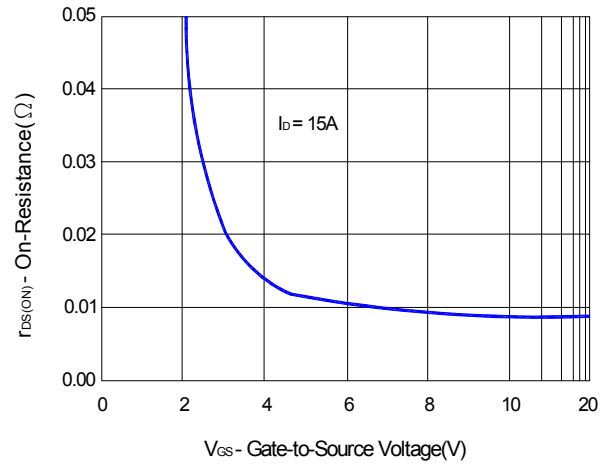

Threshold Voltage

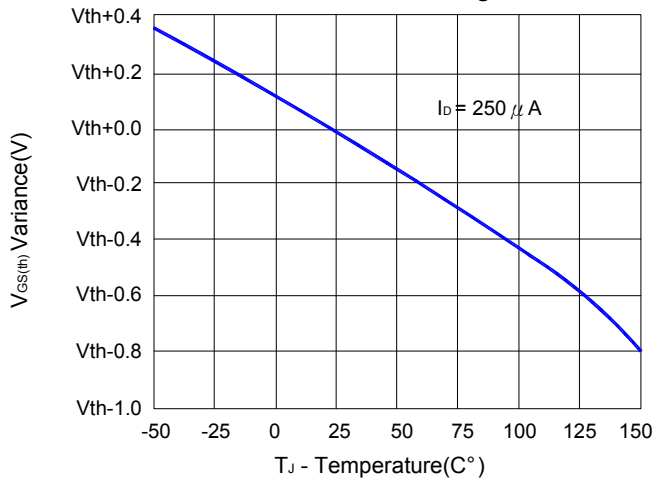

Single Pulse Maximum Power dissipation

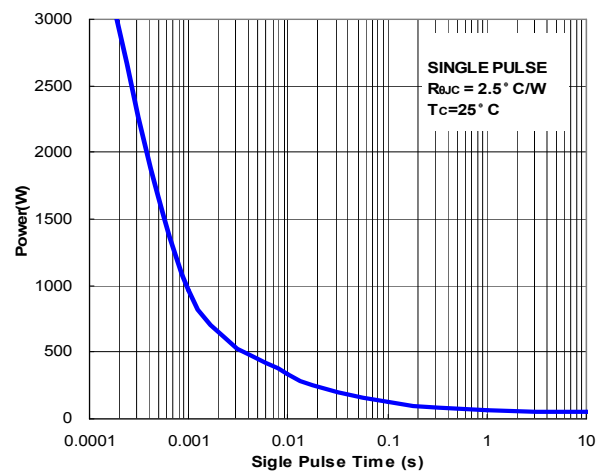

Safe Operating Area

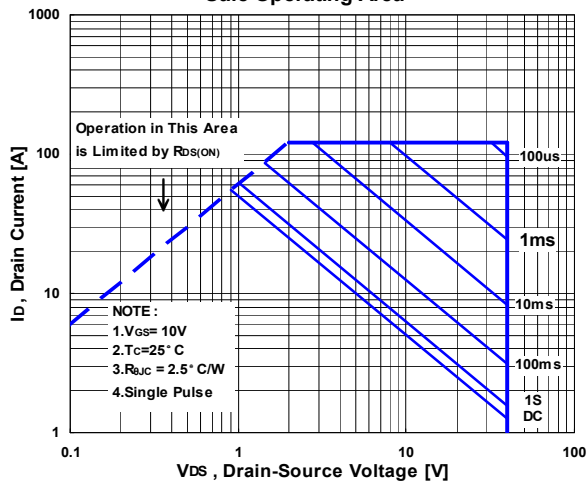

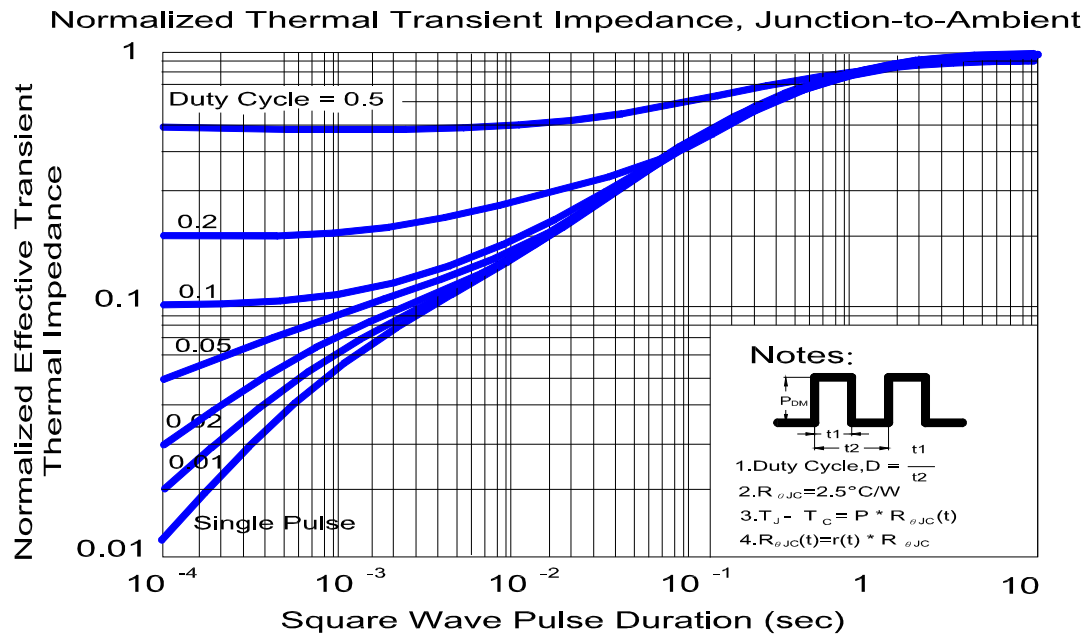

**Test Circuits and Waveforms**

**Unclamped Energy Test Circuit**

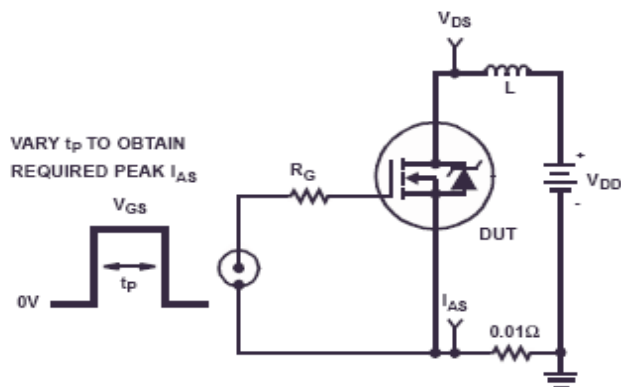

**Unclamped Energy Waveforms**

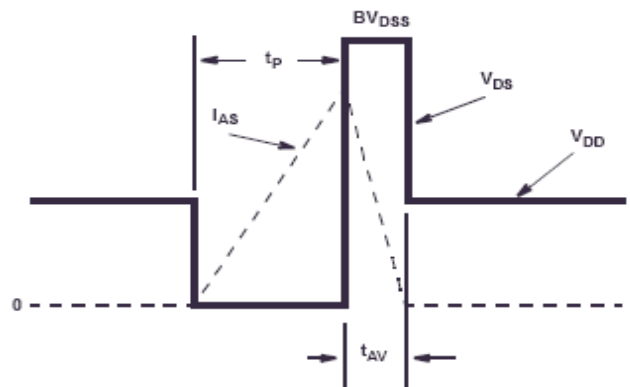

**Gate Charge Test Circuit**

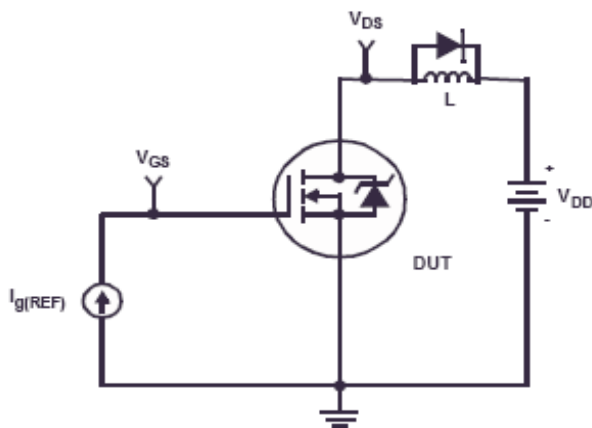

**Gate Charge Waveforms**

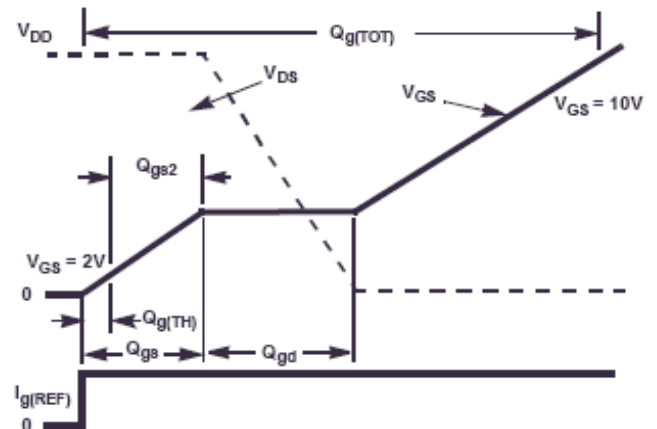

**Switching Time Test Circuit**

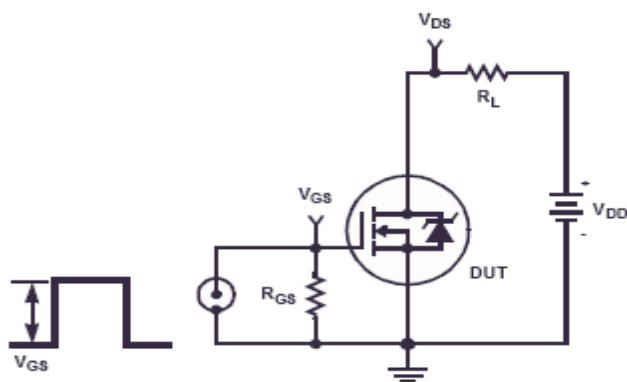

**Switching Time Waveforms**

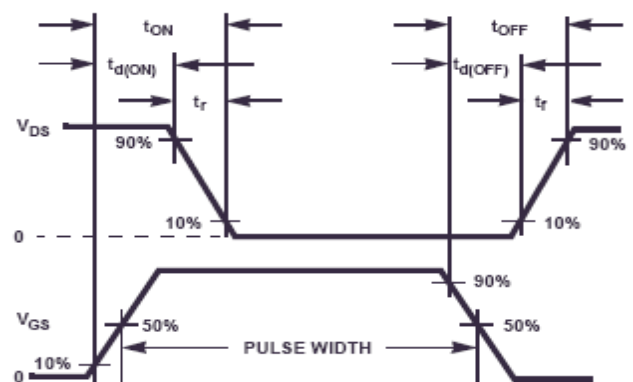

**Package Dimension**

**TO-252 (DPAK) MECHANICAL DATA**

Dimension	mm			Dimension	mm		
	Min.	Typ.	Max.		Min.	Typ.	Max.
A	9.2		10.2	J	4.8		5.5
B	2.1		2.5	K	0.5		1.1
C	0.4		0.6	L	0.30		0.889
D	1.1		1.3	M	4.58		4.8
E		0.508		S	4.57		5.515
F	0		0.3	T	3.81		5.0
G	5.3		6.2	U	1.4		1.77
H	1.1		1.7	V	0.86		1.5
I	6.3		6.8				

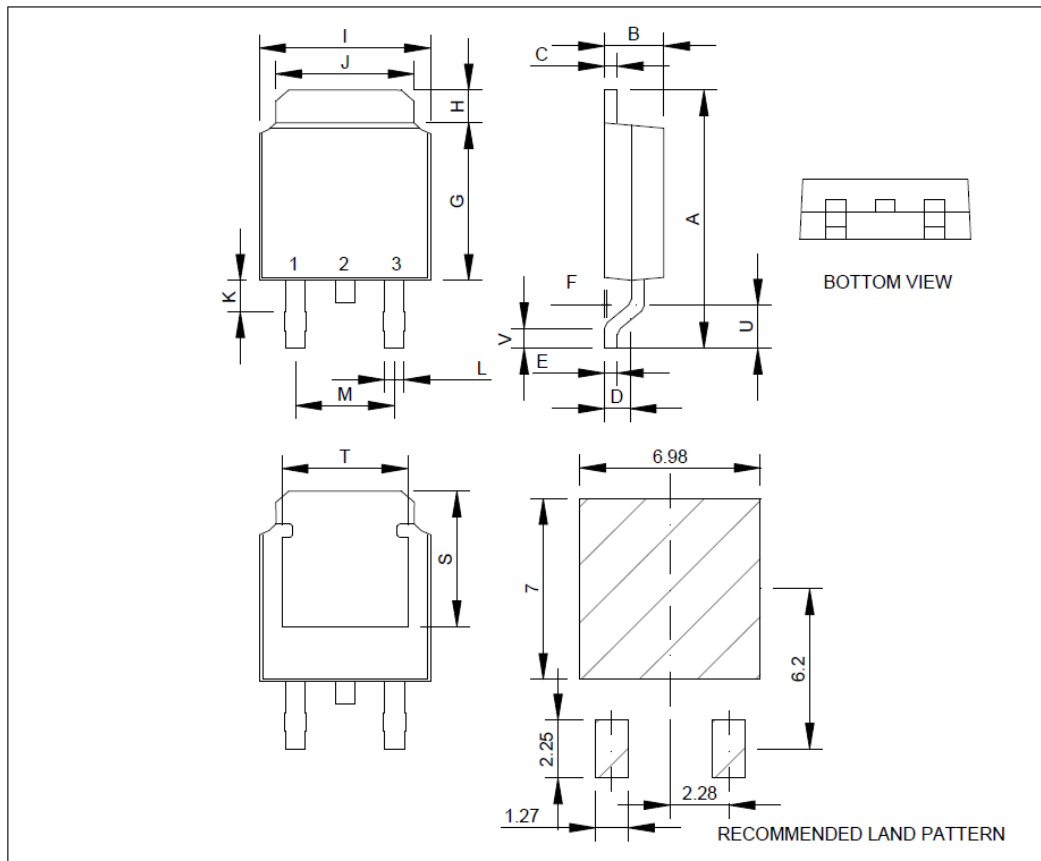

**TO-252 (DPAK) MECHANICAL DATA**

Dimension	mm			Dimension	mm		
	Min.	Typ.	Max.		Min.	Typ.	Max.
A	8.9	9.5	10.4	J	5.04	5.34	5.64
B	2.2	2.3	2.4	K	0.6		1.0
C	0.4	0.5	0.6	L	0.66	0.76	0.86
D	0.82	1.02	1.22	M	4.372	4.572	4.772
E	0.4	0.5	0.6	S	5.25		
F	0		0.1	T	4.7		5.24
G	5.9	6.1	6.3	U	1.34		1.7
H	0.5		1.25	V	0.55		0.95
I	6.4	6.6	6.8				

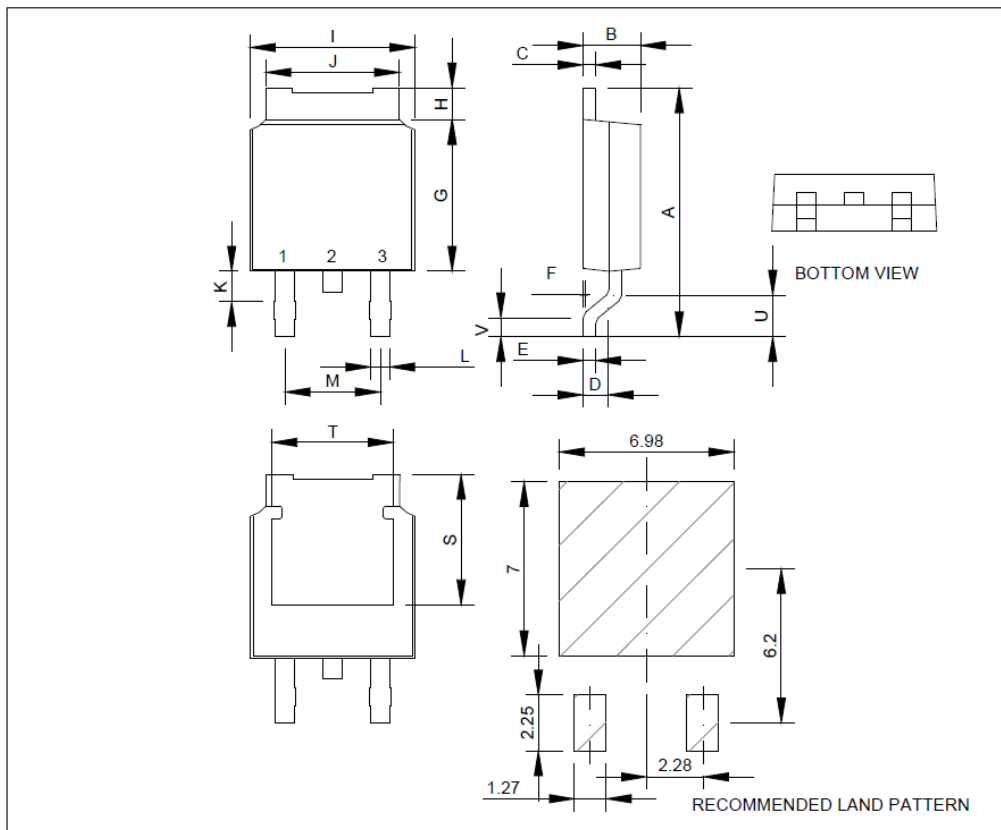



**TO-252 (DPAK) MECHANICAL DATA all**

Dimension	mm			Dimension	mm		
	Min.	Typ.	Max.		Min.	Typ.	Max.
A	9.65		10.41	J	5.21		5.46
B	2.19		2.38	K	0.64		1.01
C	0.46		0.64	L	0.64		0.89
E	0.51			M		4.58	
F			0.13	S	5.21		
G	5.97		6.22	T	4.83		
H	0.89		1.27	U	1.4		1.78
I	6.35		6.73	V	0.75		1.00

