

P168LG10GN

Power MOSFETs

100V, 168A, N-channel

Feature

- N-channel
- SMD
- Super Large Current
- Low Ron
- 10V Gate Drive
- Low Capacitance
- Halogen free
- Pb free terminal
- RoHS:Yes

OUTLINE

Package (House Name): LG

Package (JEDEC Code): MO-299B

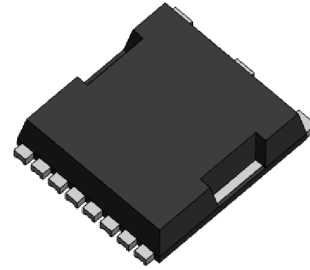

Equivalent circuit

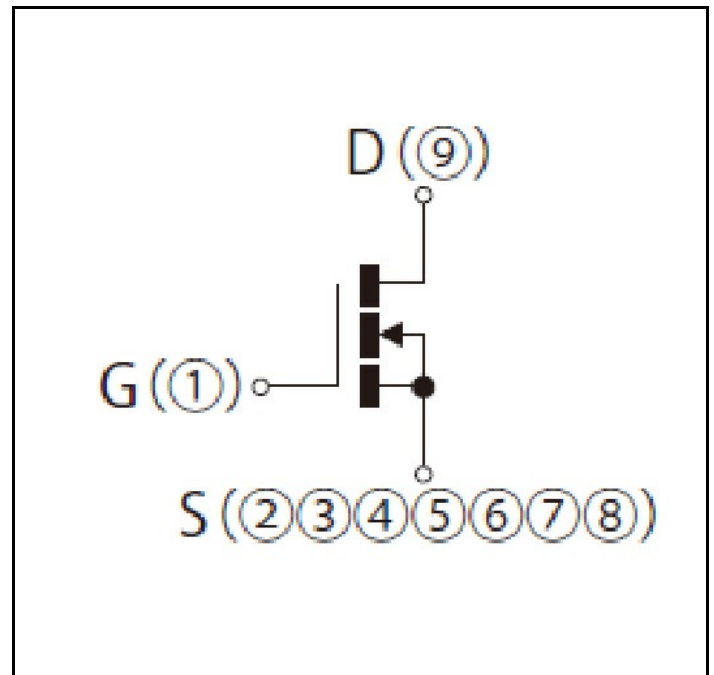

Absolute Maximum Ratings

Item	Symbol	Conditions	Ratings	Unit
Storage temperature	T _{stg}		-55 to 175	°C
Channel temperature	T _{ch}		-55 to 175	°C
Drain-source voltage	V _{DSS}		100	V
Gate-source voltage	V _{GSS}		±20	V
Continuous drain current(DC)	I _D		168	A
Continuous drain current(Peak)	I _{DP}	Pulse width 10μs, Duty=1/100	672	A
Continuous source current(DC)	I _S		168	A
Total power dissipation	P _T	With heatsink	365	W
Total power dissipation	P _T	Measured on the 1 inch ² glass epoxy substrate pattern area : 634.86mm ²	3.7	W
Total power dissipation	P _T	Measured on the 1 inch ² glass epoxy substrate pattern area : 164.16mm ²	2.7	W
Single avalanche current	I _{AS}	Starting T _{ch} =25°C T _{ch} ≤150°C	74	A
Single avalanche energy	E _{AS}	Starting T _{ch} =25°C T _{ch} ≤150°C	273	mJ

※ :See the original Specifications

Electrical Characteristics

Item	Symbol	Conditions	Ratings			Unit
			MIN	TYP	MAX	
Drain-Source breakdown voltage	$V_{(BR)DSS}$	$I_D=1mA, V_{GS}=0V$	100			V
Zero gate voltage drain current	I_{DSS}	$V_{DS}=100V, V_{GS}=0V$			1	μA
Gate-source leakage current	I_{GSS}	$V_{GS}=\pm 20V, V_{DS}=0V$			± 0.1	μA
Forward transconductance	g_{fs}	$I_D=42A, V_{DS}=10V$	35			S
Static drain-source on-state resistance	$R_{DS(ON)}$	$I_D=84A, V_{GS}=10V$		0.0025	0.0031	Ω
Gate threshold voltage	V_{th}	$I_D=1mA, V_{DS}=10V$	2	3	4	V
Source-drain diode forward voltage	V_{SD}	$I_S=84A, V_{GS}=0V$			1.2	V
Thermal resistance	$R_{th(j-c)}$	Junction to case, With heatsink			0.41	$^{\circ}C/W$
Thermal resistance	$R_{th(j-a)}$	Junction to ambient, Measured on the 1 inch ² glass epoxy substrate pattern area : 634.36mm ²			40	$^{\circ}C/W$
Thermal resistance	$R_{th(j-a)}$	Junction to ambient, Measured on the 1 inch ² glass epoxy substrate pattern area : 164.16mm ²			55	$^{\circ}C/W$
Total gate charge	Q_g	$V_{DS}=80V, V_{GS}=10V, I_D=84A$		96		nC
Gate to source charge	Q_{gs}	$V_{DS}=80V, V_{GS}=10V, I_D=84A$		28		nC
Gate to drain charge	Q_{gd}	$V_{DS}=80V, V_{GS}=10V, I_D=84A$		36		nC
Input capacitance	C_{iss}	$V_{DS}=50V, V_{GS}=0V, f=100kHz$		6035		pF
Reverse transfer capacitance	C_{rss}	$V_{DS}=50V, V_{GS}=0V, f=100kHz$		31		pF
Output capacitance	C_{oss}	$V_{DS}=50V, V_{GS}=0V, f=100kHz$		1100		pF
Turn-on delay time	$t_{d(on)}$	$I_D=42A, R_L=1.19\Omega, V_{DS}=50V, R_g=0\Omega, +V_{GS}=10V, -V_{GS}=0V$		16		ns
Rise time	t_r	$I_D=42A, R_L=1.19\Omega, V_{DS}=50V, R_g=0\Omega, +V_{GS}=10V, -V_{GS}=0V$		25		ns
Turn-off delay time	$t_{d(off)}$	$I_D=42A, R_L=1.19\Omega, V_{DS}=50V, R_g=0\Omega, +V_{GS}=10V, -V_{GS}=0V$		36		ns
Fall time	t_f	$I_D=42A, R_L=1.19\Omega, V_{DS}=50V, R_g=0\Omega, +V_{GS}=10V, -V_{GS}=0V$		10		ns
Diode reverse recovery time	t_{rr}	$I_S=84A, V_{GS}=0V, -di/dt=100A/\mu s$		90		ns
Diode reverse recovery charge	Q_{rr}	$I_S=84A, V_{GS}=0V, -di/dt=100A/\mu s$		209		nC

※ : See the original Specifications

CHARACTERISTIC DIAGRAMS

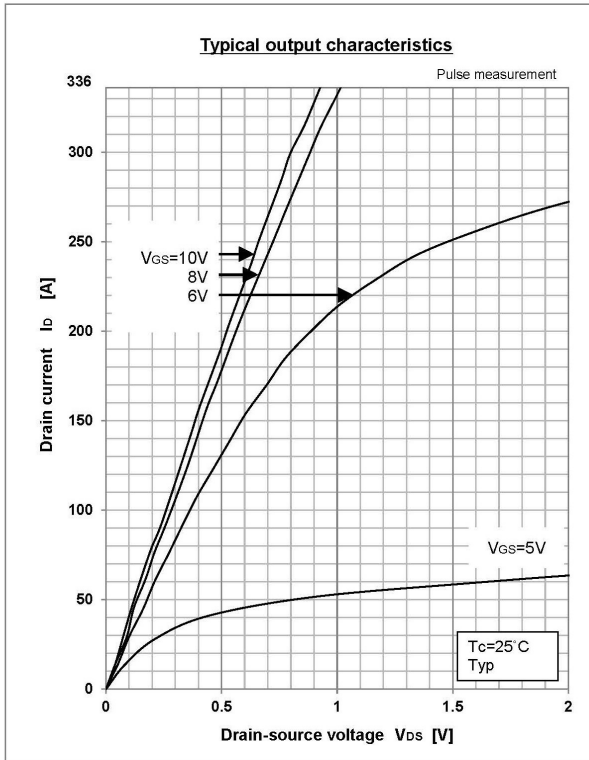

Note: The above characteristics curves are presented for reference only and not guaranteed by production test, unless otherwise noted.

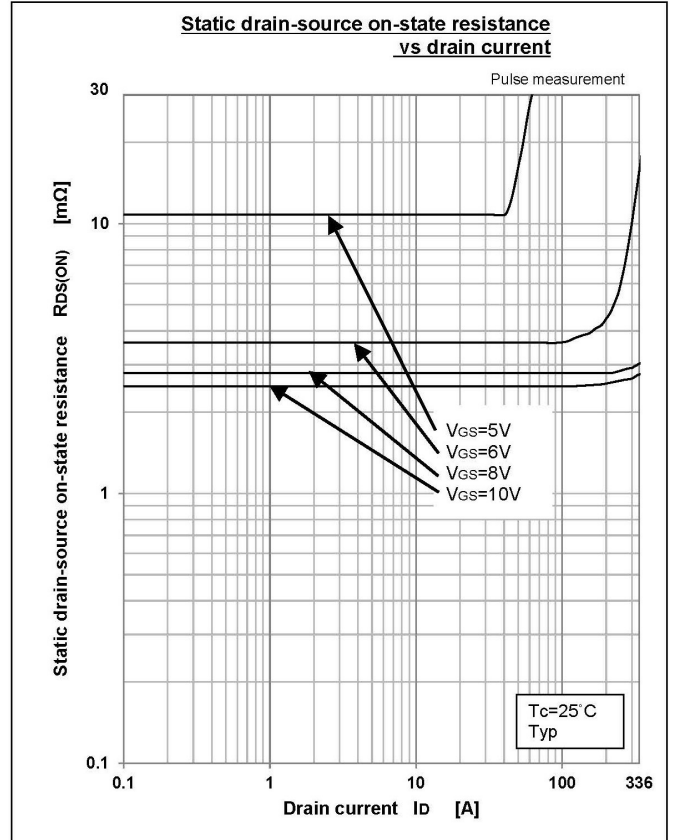
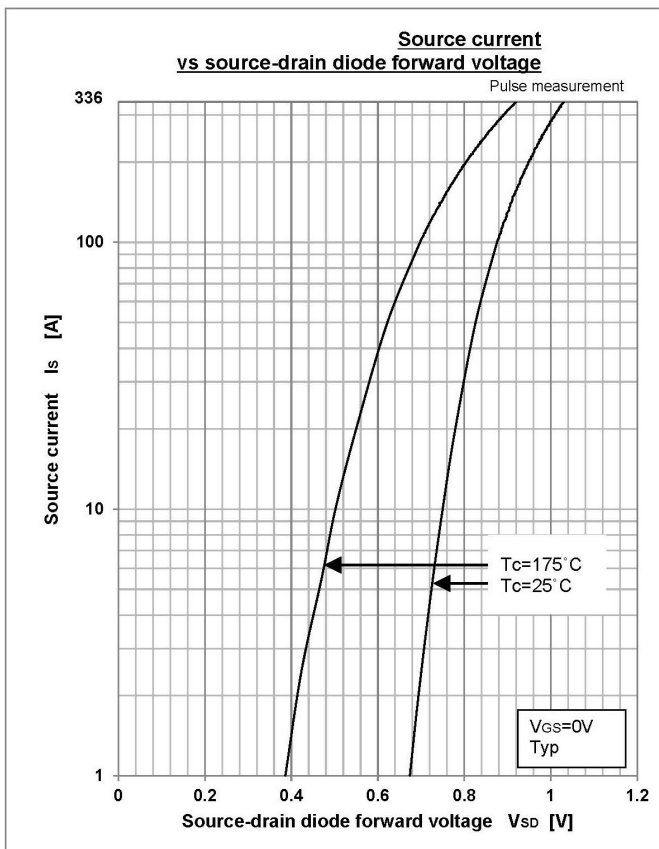
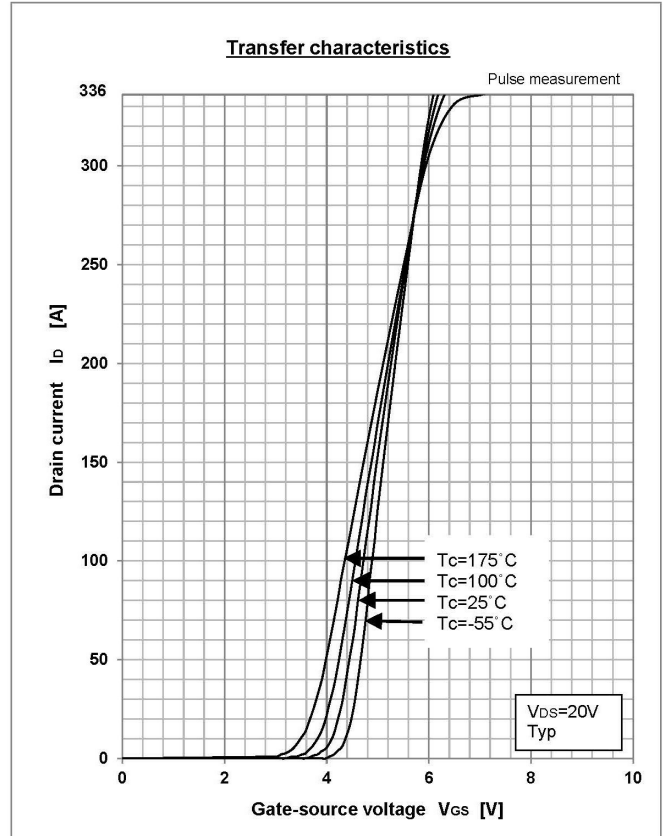

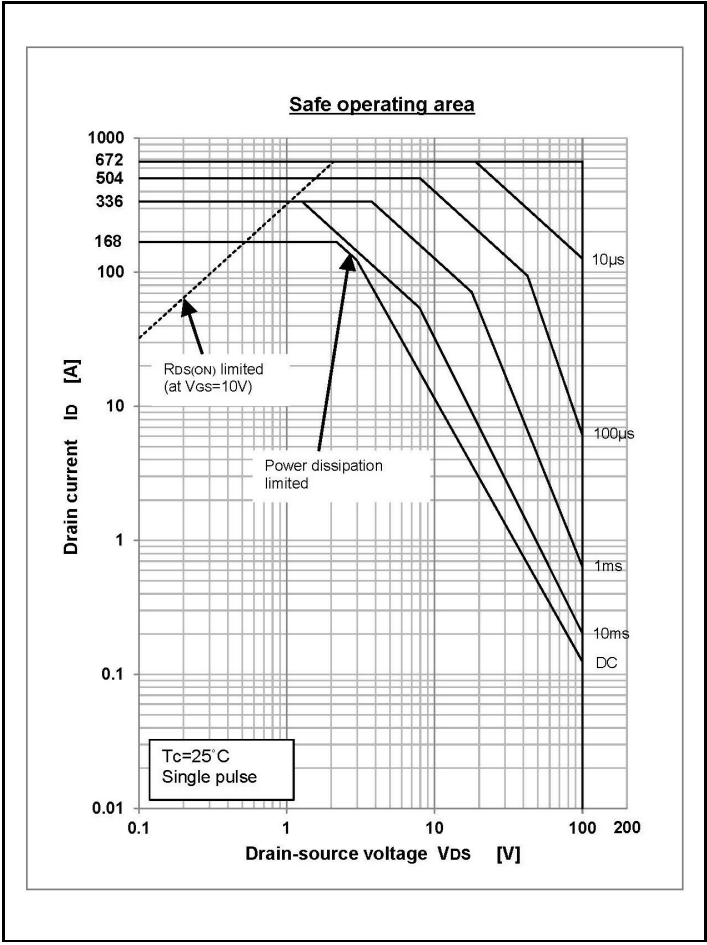
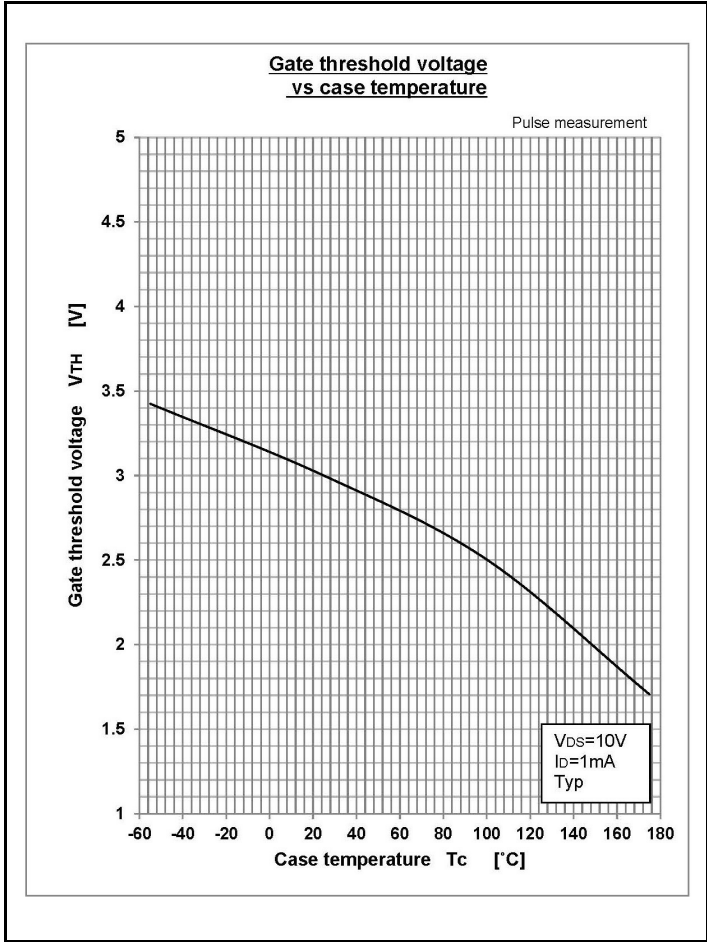
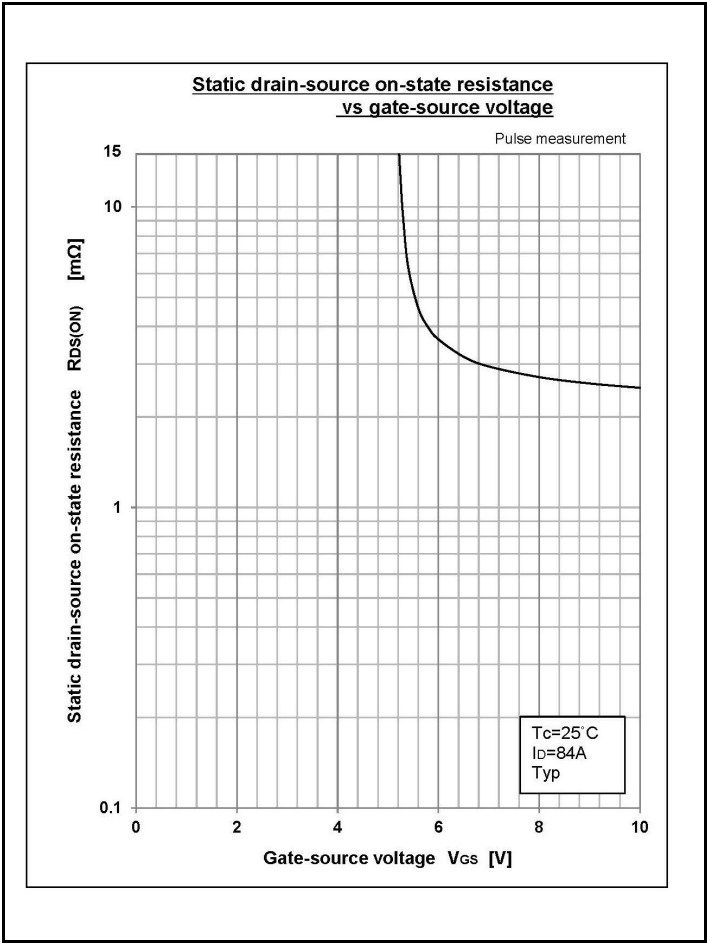
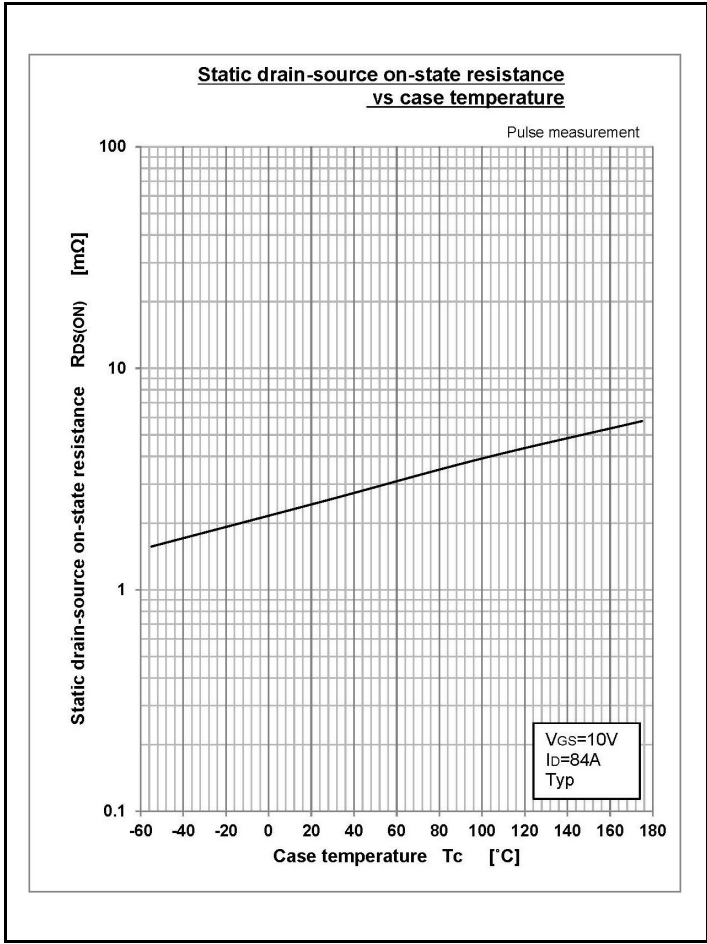

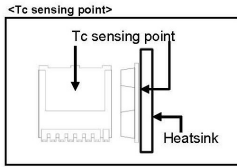
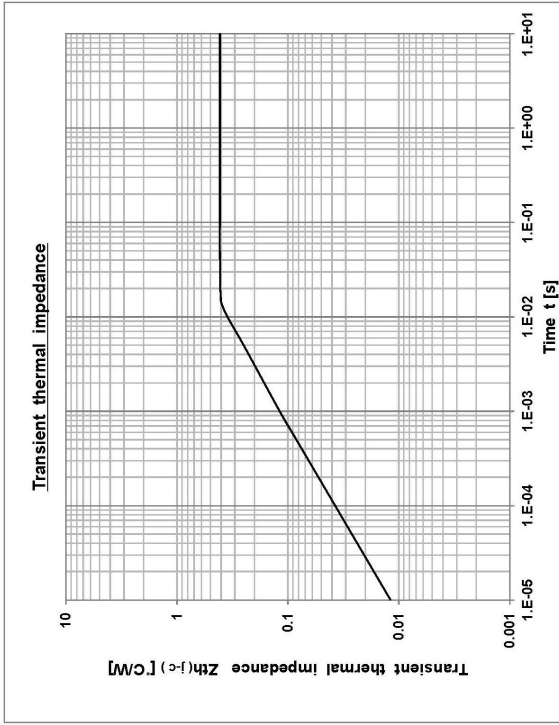

Specification No.

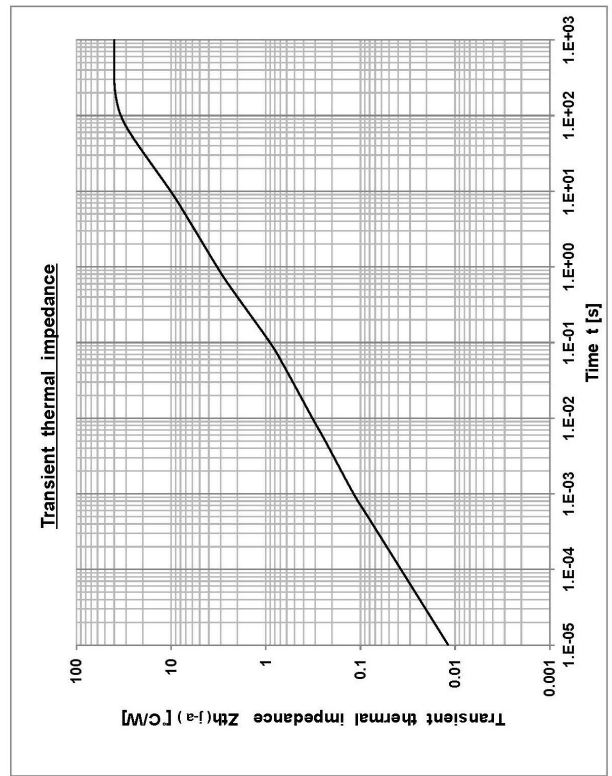

<Substrate detail>

Type	Glass-epoxy
Size	1 inch ²
Thickness	1.6 mm
Conductor thickness	70 μm
Pattern area	634.86 mm ²

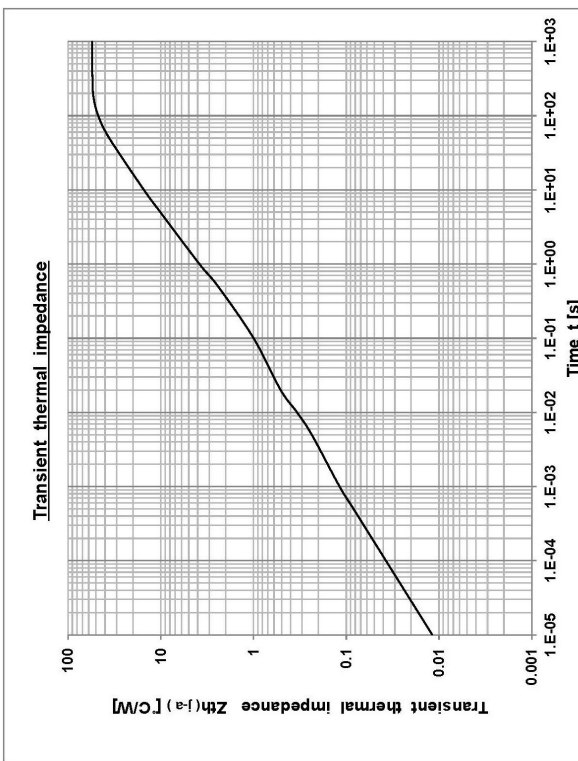

<Substrate detail>

Type	Glass-epoxy
Size	1 inch ²
Thickness	1.6 mm
Conductor thickness	70 μm
Pattern area	164.16 mm ²

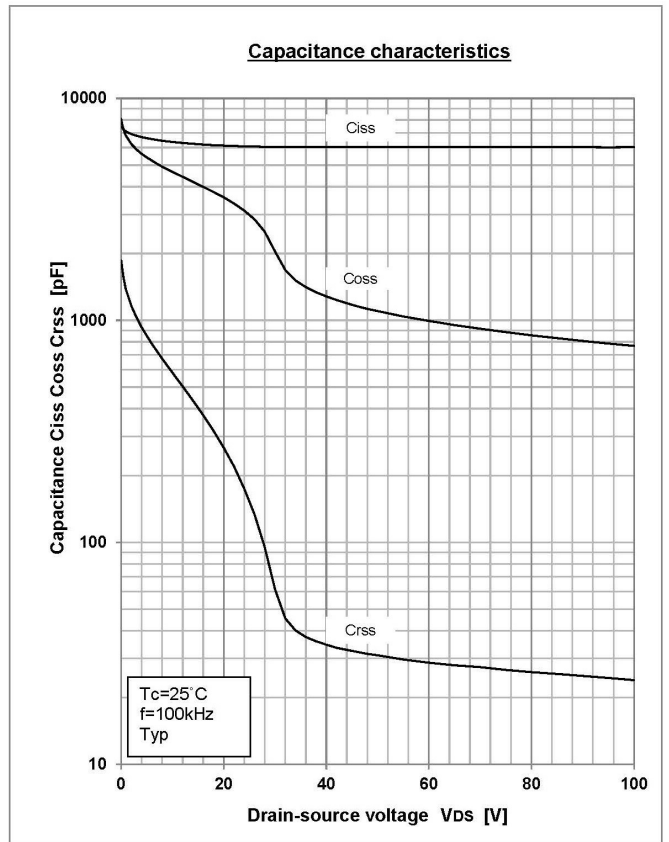

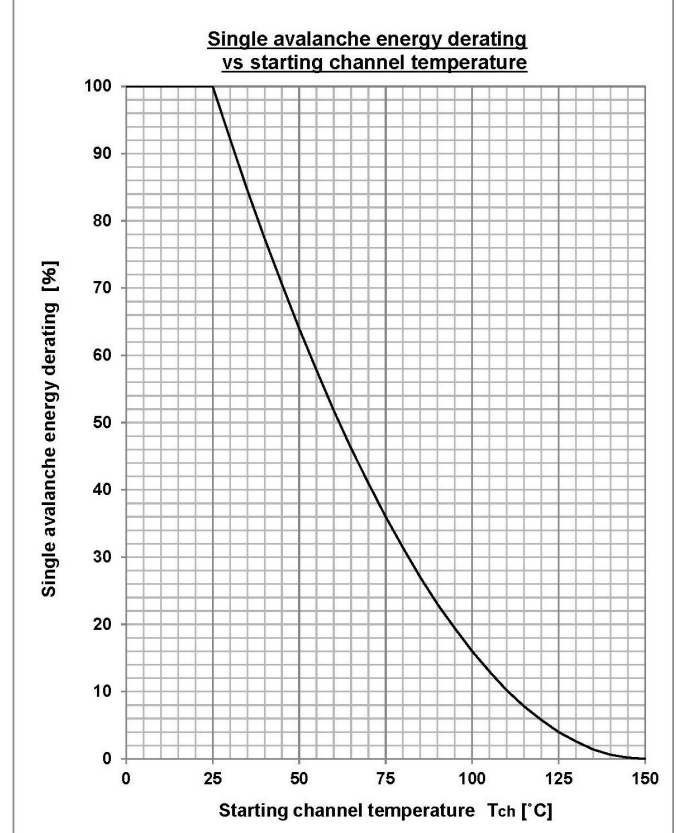
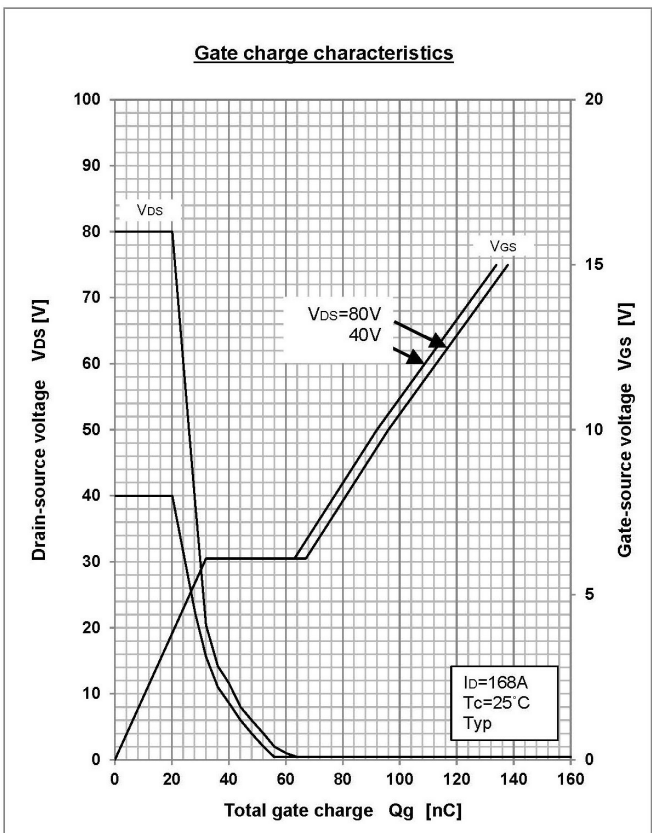
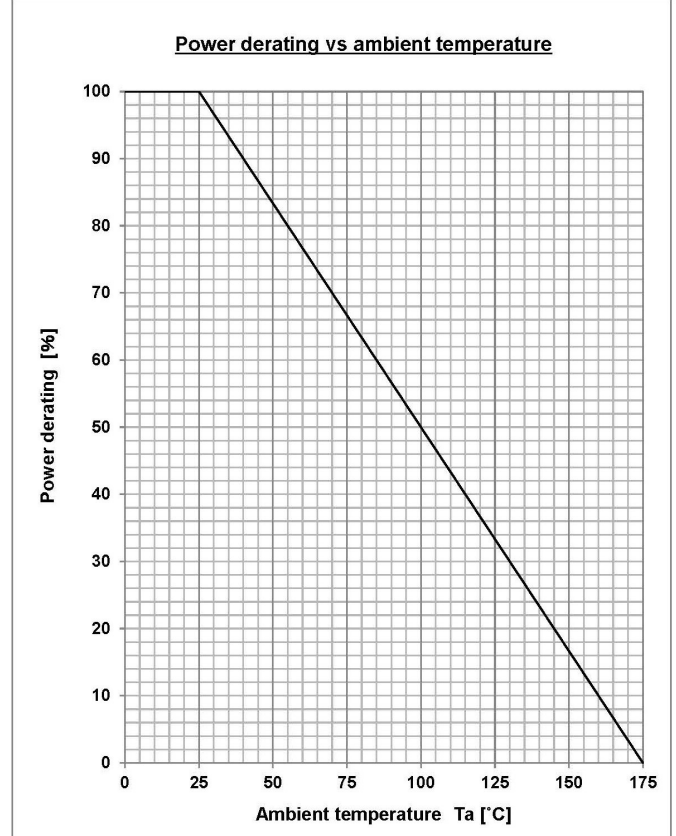
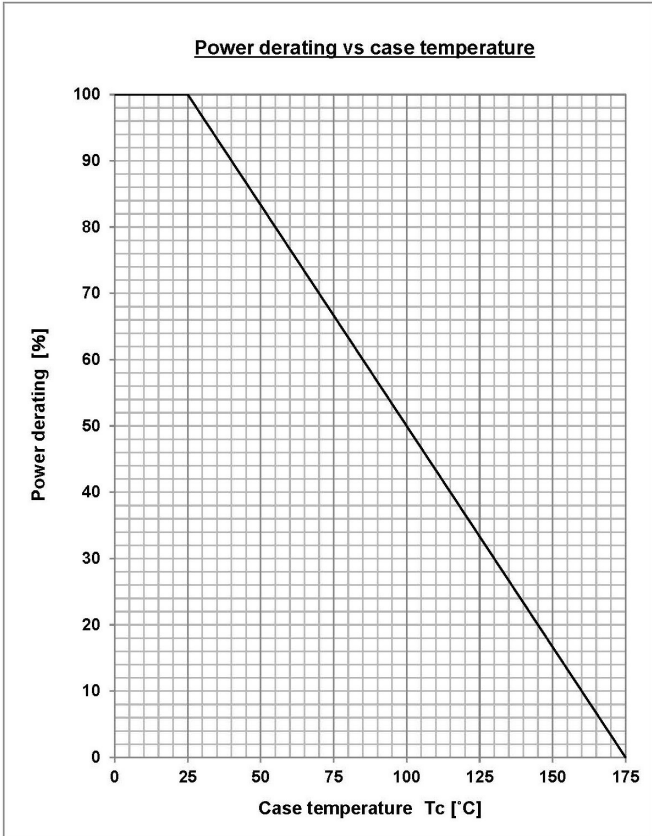

G9

JEDEC Code	MO-299B
JEITA Code	-
House Name	LG(TOLL)

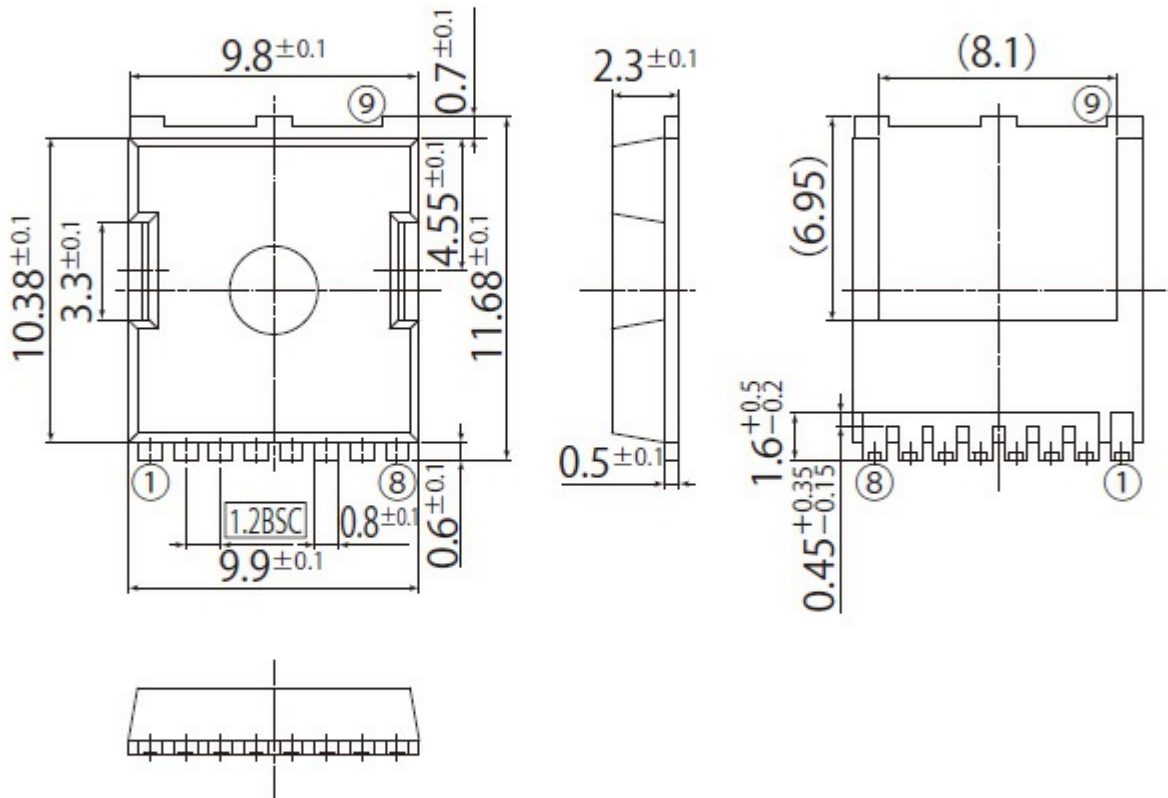

Notes

1. If you wish to use any such product, please be sure to refer to the specifications issued by Shindengen.
2. All products described or contained herein are designed with a quality level intended for use in standard applications requiring an ordinary level of reliability. If these products are to be used in equipment or devices for special or specific applications requiring an extremely high grade of quality or reliability in which failures or malfunctions of products may directly affect human life or health, a local Shindengen office must be contacted in advance to confirm that the intended use of the product is appropriate. Shindengen products are grouped into the following three applications according to the quality grade.
 - 【Standard applications】
Computers, office automation and other office equipment, communication terminals, test and measurement equipment, audio/visual equipment, amusement equipment, consumer electronics, machine tools, personal electronic equipment, industrial equipment, etc.
 - 【Special applications】
Transportation equipment (vehicles, ships, etc.), trunk-line communication equipment, traffic signal control systems, anti-disaster/crime systems, safety equipment, medical equipment, etc.
 - 【Specific applications】
Nuclear reactor control systems, aircraft, aerospace equipment, submarine repeaters, life support equipment and systems, etc.
3. Although Shindengen continuously endeavors to enhance the quality and reliability of its products, customers are advised to consider and take safety measures in their design, such as redundancy, fire containment and anti-failure, so that personal injury, fires, or societal damages can be prevented.
4. Please note that all information described or contained herein is subject to change without notice due to product upgrades and other reasons. When buying Shindengen products, please contact the Company's offices or distributors to obtain the latest information.
5. Shindengen shall not bear any responsibility with regards to damages or infringement of any third-party patent rights and other intellectual property rights incurred due to the use of information on this website.
6. The information and materials on this website neither warrant the use of Shindengen's or any third party's patent rights and other intellectual property rights, nor grant license to such rights.
7. In the event that any product described or contained herein falls under the category of strategic products controlled under the Foreign Exchange and Foreign Trade Control Law of Japan, exporting of such products shall require an export license from the Japanese government in accordance with the above law.
8. No reprinting or reproduction of the materials on this website, either in whole or in part, is permitted without proper authorization from Shindengen.