

P1R5B40HP2

Power MOSFETs

400V, 1.5A, N-channel

Feature

- N-channel
- SMD
- High Voltage
- Low Capacitance
- High Avalanche Durability, High di/dt Durability
- Pb free terminal
- RoHS:Yes

OUTLINE

Package (House Name): FB

Package (JEDEC Code): TO-252AA



Equivalent circuit

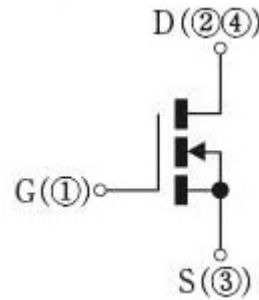

Absolute Maximum Ratings (unless otherwise specified : Tc=25°C)

Item	Symbol	Conditions	Ratings	Unit
Storage temperature	T _{stg}		-55 to 150	°C
Channel temperature	T _{ch}		150	°C
Drain-source voltage	V _{DSS}		400	V
Gate-source voltage	V _{GSS}		±30	V
Continuous drain current(DC)	I _D		1.5	A
Continuous drain current(Peak)	I _{DP}	Pulse width 10μs, duty=1/100	6	A
Continuous source current(DC)	I _S		1.5	A
Total power dissipation	P _T		35	W
Repetitive avalanche current	I _{AR}	Starting T _{ch} =25°C T _{ch} ≤150°C	1.5	A
Single avalanche energy	E _{AS}	Starting T _{ch} =25°C T _{ch} ≤150°C	15	mJ
Repetitive avalanche energy	E _{AR}	Starting T _{ch} =25°C T _{ch} ≤150°C	1.5	mJ
Drain-source diode di/dt strength	di/dt	I _S =1.5A, T _c =25°C	350	A/μs

* :See the original Specifications

Electrical Characteristics (unless otherwise specified : Tc=25°C)

Item	Symbol	Conditions	Ratings			Unit
			MIN	TYP	MAX	
Drain-Source breakdown voltage	$V_{(BR)DSS}$	ID=1mA, VGS=0V	400			V
Zero gate voltage drain current	I_{DSS}	VDS=400V, VGS=0V			100	μ A
Gate-source leakage current	I_{GSS}	VGS=±25V, VDS=0V			±10	μ A
Forward transconductance	g_{fs}	ID=0.75A, VDS=10V	0.6	1.3		S
Static drain-source on-state resistance	$R_{DS(ON)}$	ID=0.75A, VGS=10V		4.2	5	Ω
Gate threshold voltage	V_{th}	ID=1mA, VDS=10V	3	3.75	4.5	V
Source-drain diode forward voltage	V_{SD}	IS=0.75A, VGS=0V			1.5	V
Thermal resistance	$R_{th(j-c)}$	Junction to case			3.55	$^{\circ}$ C/W
Total gate charge	Q_g	VDD=320V, VGS=10V, ID=1.5A		3.9		nC
Input capacitance	C_{iss}	VDS=50V, VGS=0V, f=1MHz		120		pF
Reverse transfer capacitance	C_{rss}	VDS=50V, VGS=0V, f=1MHz		3.4		pF
Output capacitance	C_{oss}	VDS=50V, VGS=0V, f=1MHz		20		pF
Turn-on delay time	$t_{d(on)}$	ID=0.75A, RL=200 Ω , VDD=150V, Rg=50 Ω , VGS(+)=10V, VGS(-)=0V		10		ns
Rise time	t_r	ID=0.75A, RL=200 Ω , VDD=150V, Rg=50 Ω , VGS(+)=10V, VGS(-)=0V		17		ns
Turn-off delay time	$t_{d(off)}$	ID=0.75A, RL=200 Ω , VDD=150V, Rg=50 Ω , VGS(+)=10V, VGS(-)=0V		24		ns
Fall time	t_f	ID=0.75A, RL=200 Ω , VDD=150V, Rg=50 Ω , VGS(+)=10V, VGS(-)=0V		13		ns

* : See the original Specifications

CHARACTERISTIC DIAGRAMS

Typical Output Characteristics

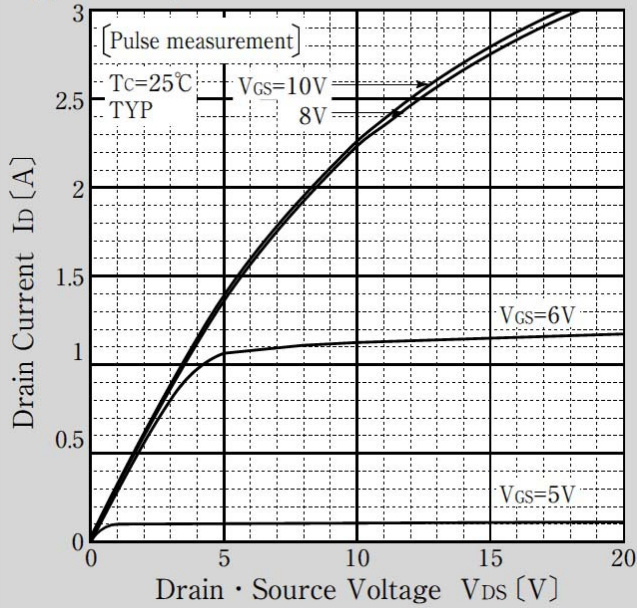

Transfer Characteristics

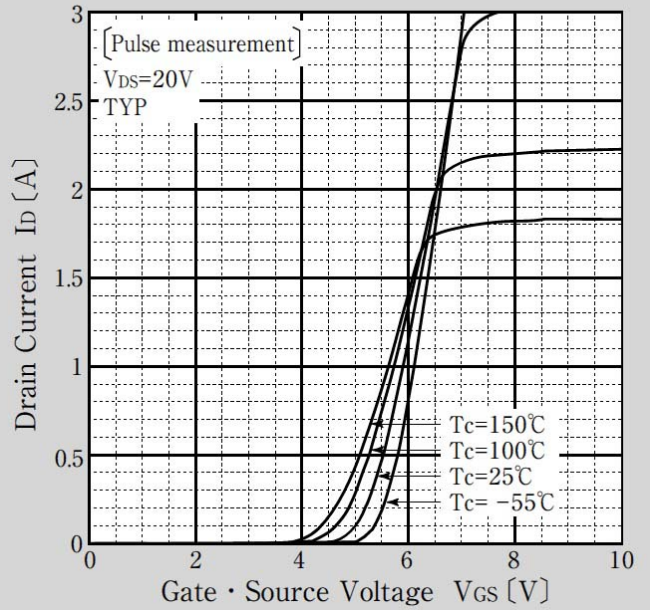

Static Drain-Source On-state Resistance vs Drain Current

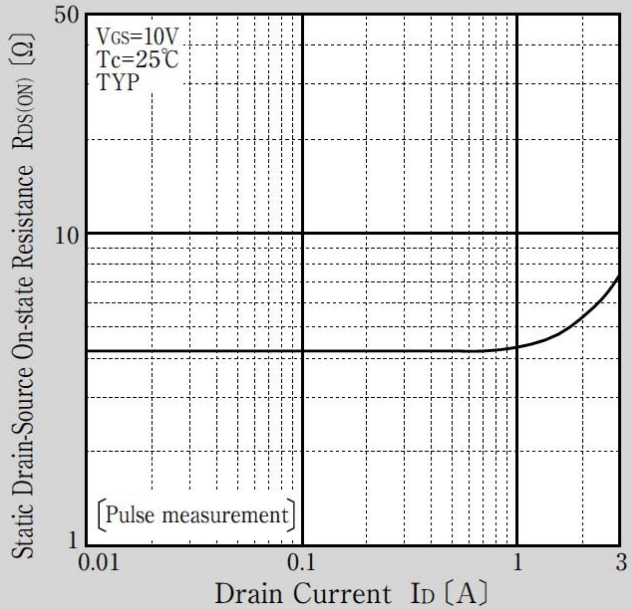

Static Drain-Source On-state Resistance vs Case Temperature

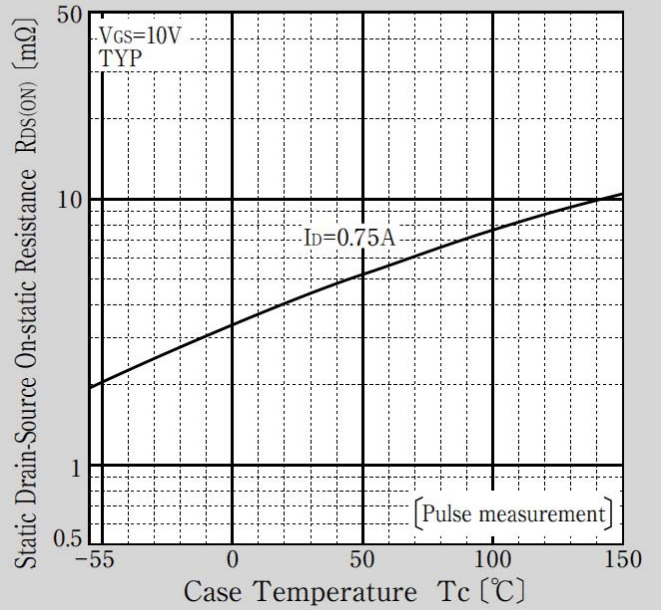

Gate Threshold Voltage vs Case Temperature

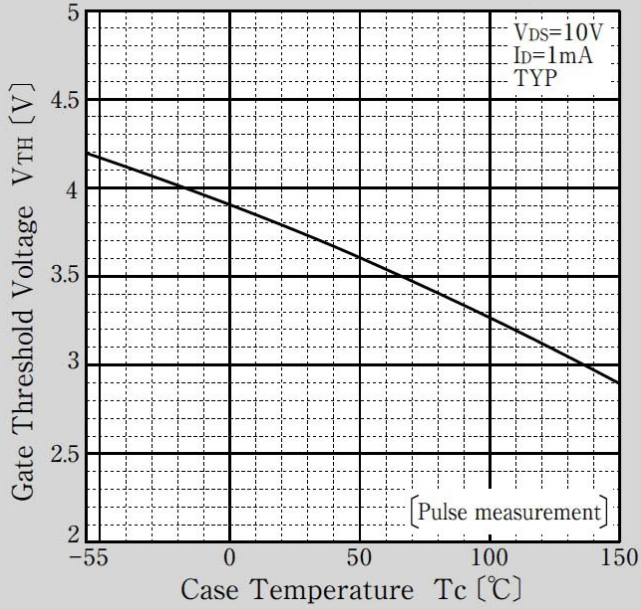

Safe Operating Area

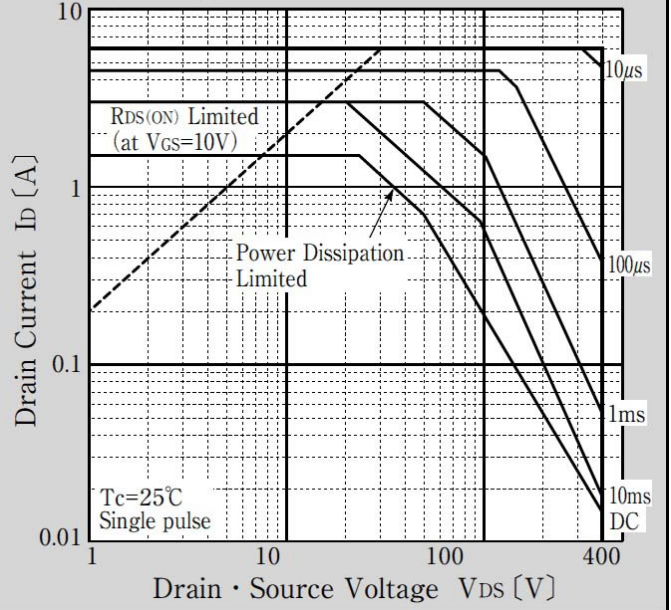

Transient Thermal Impedance

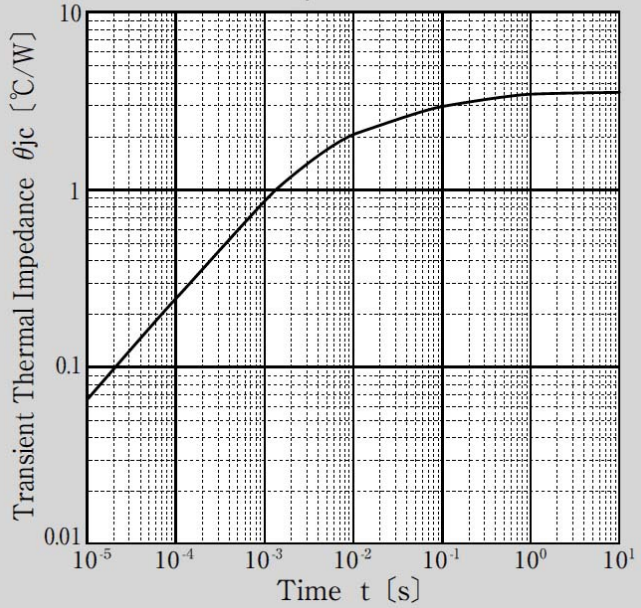

Capacitance Characteristics

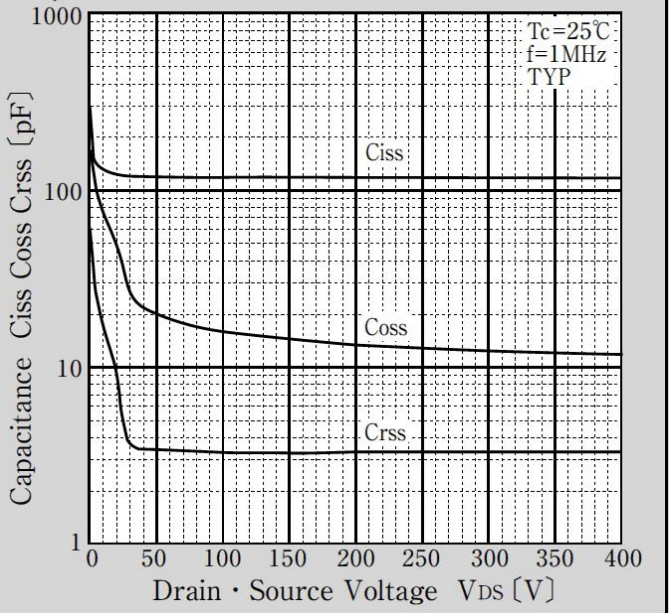

Power Derating - Case Temperature

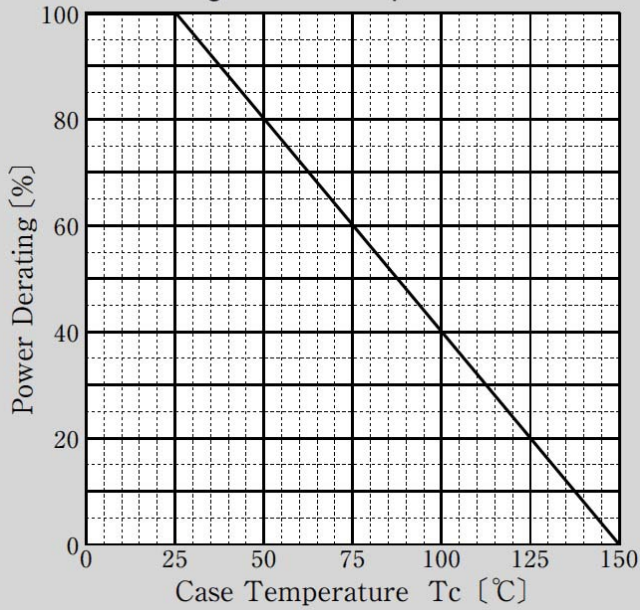

Gate Charge Characteristics

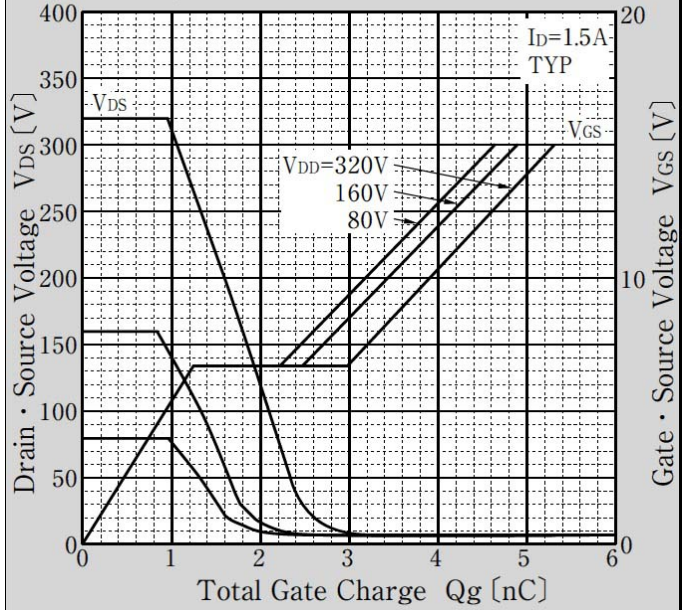

Single Avalanche Energy Derating vs Channel Temperature

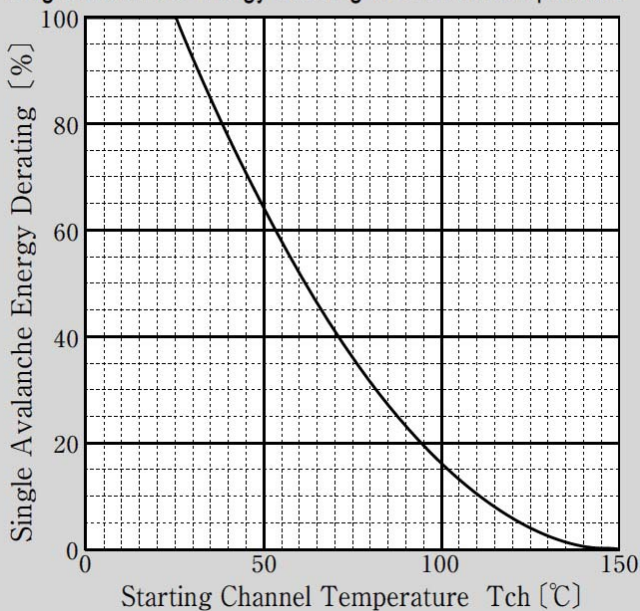

Single Avalanche Current vs Inductive Load

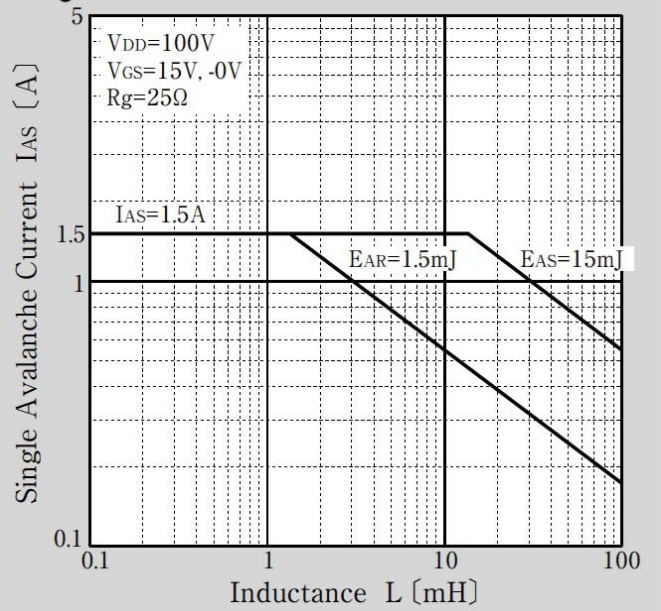

G2

JEDEC Code	TO-252AA
JEITA Code	-
House Name	FB

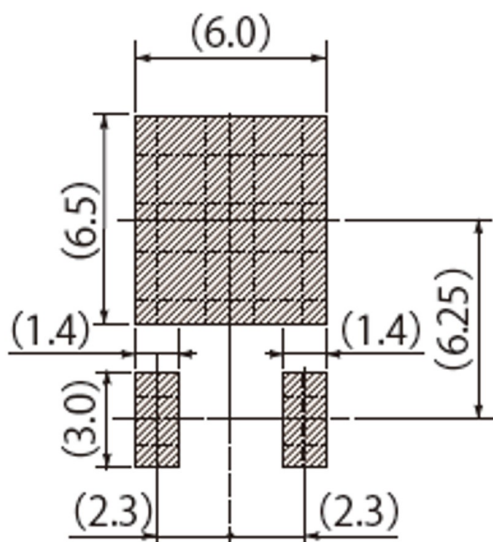
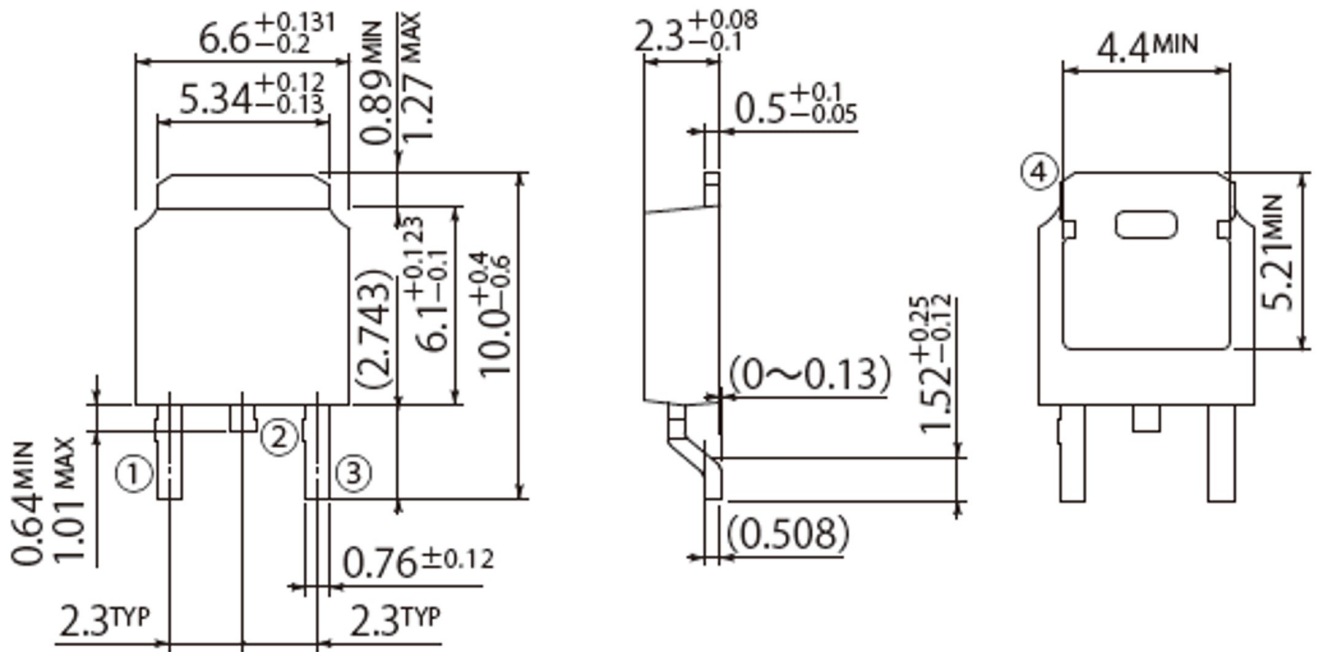

Referential Soldering Pad

1. If you wish to use any such product, please be sure to refer to the specifications issued by Shindengen.
2. All products described or contained herein are designed with a quality level intended for use in standard applications requiring an ordinary level of reliability. If these products are to be used in equipment or devices for special or specific applications requiring an extremely high grade of quality or reliability in which failures or malfunctions of products may directly affect human life or health, a local Shindengen office must be contacted in advance to confirm that the intended use of the product is appropriate. Shindengen products are grouped into the following three applications according to the quality grade.
 - 【Standard applications】
Computers, office automation and other office equipment, communication terminals, test and measurement equipment, audio/visual equipment, amusement equipment, consumer electronics, machine tools, personal electronic equipment, industrial equipment, etc.
 - 【Special applications】
Transportation equipment (vehicles, ships, etc.), trunk-line communication equipment, traffic signal control systems, anti-disaster/crime systems, safety equipment, medical equipment, etc.
 - 【Specific applications】
Nuclear reactor control systems, aircraft, aerospace equipment, submarine repeaters, life support equipment and systems, etc.
3. Although Shindengen continuously endeavors to enhance the quality and reliability of its products, customers are advised to consider and take safety measures in their design, such as redundancy, fire containment and anti-failure, so that personal injury, fires, or societal damages can be prevented.
4. Please note that all information described or contained herein is subject to change without notice due to product upgrades and other reasons. When buying Shindengen products, please contact the Company's offices or distributors to obtain the latest information.
5. Shindengen shall not bear any responsibility with regards to damages or infringement of any third-party patent rights and other intellectual property rights incurred due to the use of information on this website.
6. The information and materials on this website neither warrant the use of Shindengen's or any third party's patent rights and other intellectual property rights, nor grant license to such rights.
7. In the event that any product described or contained herein falls under the category of strategic products controlled under the Foreign Exchange and Foreign Trade Control Law of Japan, exporting of such products shall require an export license from the Japanese government in accordance with the above law.
8. No reprinting or reproduction of the materials on this website, either in whole or in part, is permitted without proper authorization from Shindengen.