



PFC Device Corporation

P20200E
P20200D

20A 200V MOS Schottky Rectifier

Major ratings and characteristics

| Characteristics | Values | Units |
|--------------------------------------|-------------|------------|
| $I_{F(AV)}$ Rectangular Waveform | 10 × 2 | A |
| V_{RRM} | 200 | V |
| $V_F@ 10A, T_J=125^\circ C$ | 0.72 | V, typ. |
| T_J Operating Junction Temperature | -65 to +175 | $^\circ C$ |

Features

- Low Forward Voltage Drop
- Reliable High Temperature Operation
- Softest, fast switching capability
- 175 $^\circ C$ Operating Junction Temperature
- Lead Free Finish, RoHS Compliant

Typical Applications

Device optimized for low forward voltage drop to maximize efficiency in Power Supply applications

P20200E

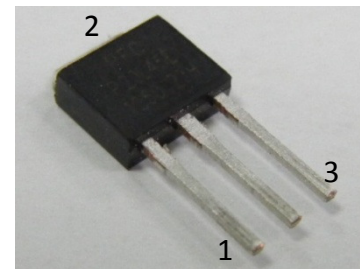

TO-251 (I-PAK)

P20200D

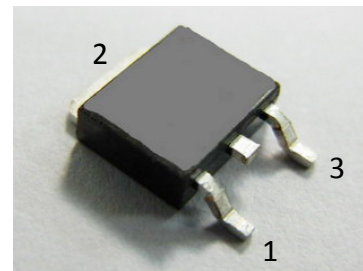

TO-252 (D-PAK)

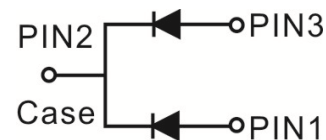

1. Characteristics

Maximum Ratings Characteristics ($T_A = 25^\circ\text{C}$ unless otherwise specified)

| Parameter | Symbol | Values | Units |
|--|----------------|--------------|-----------------------------|
| DC Blocking Voltage | V_{RM} | 200 | Volts |
| Working Peak Reverse Voltage | V_{RWM} | | |
| Peak Repetitive Reverse Voltage | V_{RRM} | | |
| Average Rectified Forward Current Per device (Rated VR-20Khz Square Wave) - 50% duty cycle | I_o | 20 | Amps |
| Peak Forward Surge Current - 1/2 60hz | I_{FSM} | 100 | Amps |
| Peak Repetitive Reverse Surge Current (2uS-1Khz) | I_{RRM} | 1 | Amps |
| Typical Thermal Resistance (per leg) Package = I-PAK TO-251 Package D-PAK TO-252 | $R\theta_{JC}$ | 6 6 | $^\circ\text{C} / \text{W}$ |
| Maximum Rate of Voltage Change (at Rated V_R) | dv/dt | 10000 | V/uS |
| Operating Junction Temperature | T_J | - 65 to +175 | $^\circ\text{C}$ |
| Storage Junction Temperature | T_{STG} | - 65 to +175 | |

Electrical Characteristics - (per leg) ($T_A = 25^\circ\text{C}$ unless otherwise specified)

| Parameter | Test Conditions | Symbol | Typ. | Max. | Units |
|-------------------------------|----------------------|---------|---------------------------|------|---------------|
| Instantaneous Forward Voltage | $I_F = 10 \text{ A}$ | V_F^* | ---- | 0.95 | Volts |
| | | | $T_J = 125^\circ\text{C}$ | 0.72 | |
| Instantaneous Reverse Current | At V_{RM} | I_R^* | ---- | 100 | μA |
| | | | $T_J = 125^\circ\text{C}$ | ---- | 10 |

* Pulse width < 300 uS, Duty cycle < 2%



2. Characteristics Curves

Ratings and Characteristics Curves

(TA = 25°C unless otherwise specified)

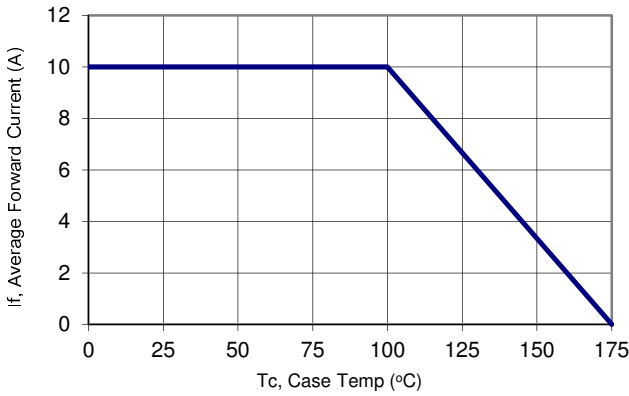

Figure 1: Current Derating, Case

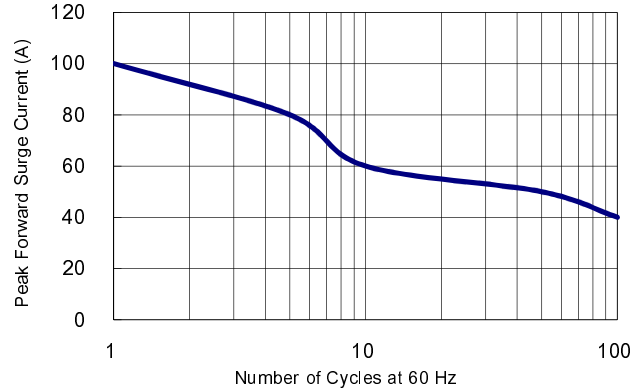

Figure 2: Maximum Repetitive Surge Current

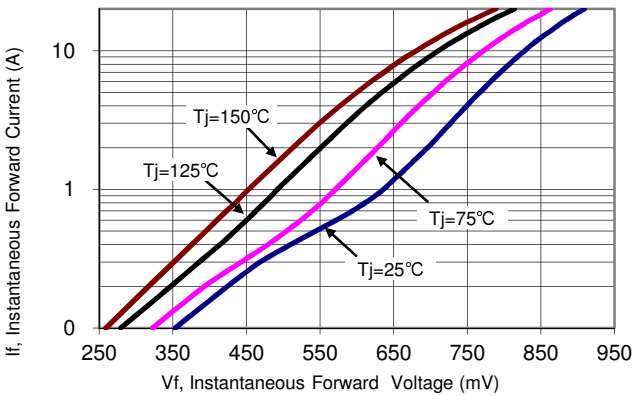

Figure 3: Typical Forward Voltage

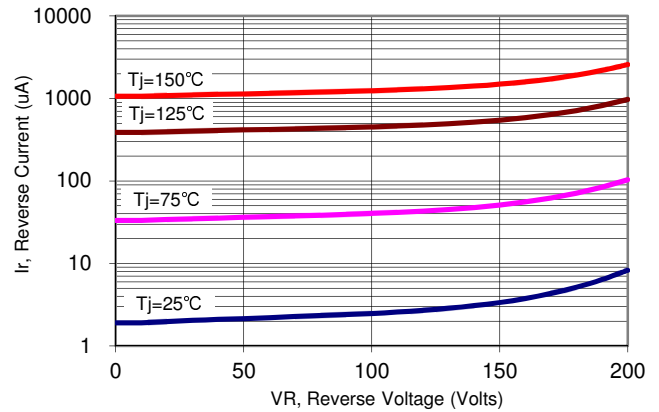

Figure 4: Typical Reverse Current

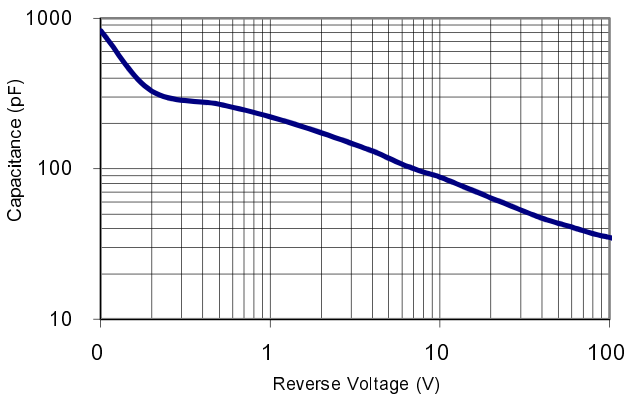

Figure 5: Typical Junction Capacitance



3. Marking information

Top Marking Rule

PFC
P20200E
YYWW ABH

P20200E = Product Type Marking Code
 YYWW = Date Code
 YY = Last two digits of year
 WW = Week code
 AB = Assembly code
 H = Halogen Free (N/A = common molding compound)

PFC
P20200D
YYWW ABH

P20200D = Product Type Marking Code
 YYWW = Date Code
 YY = Last two digits of year
 WW = Week code
 AB = Assembly code
 H = Halogen Free (N/A = common molding compound)



4. Package information

Package Outline Dimensions millimeters

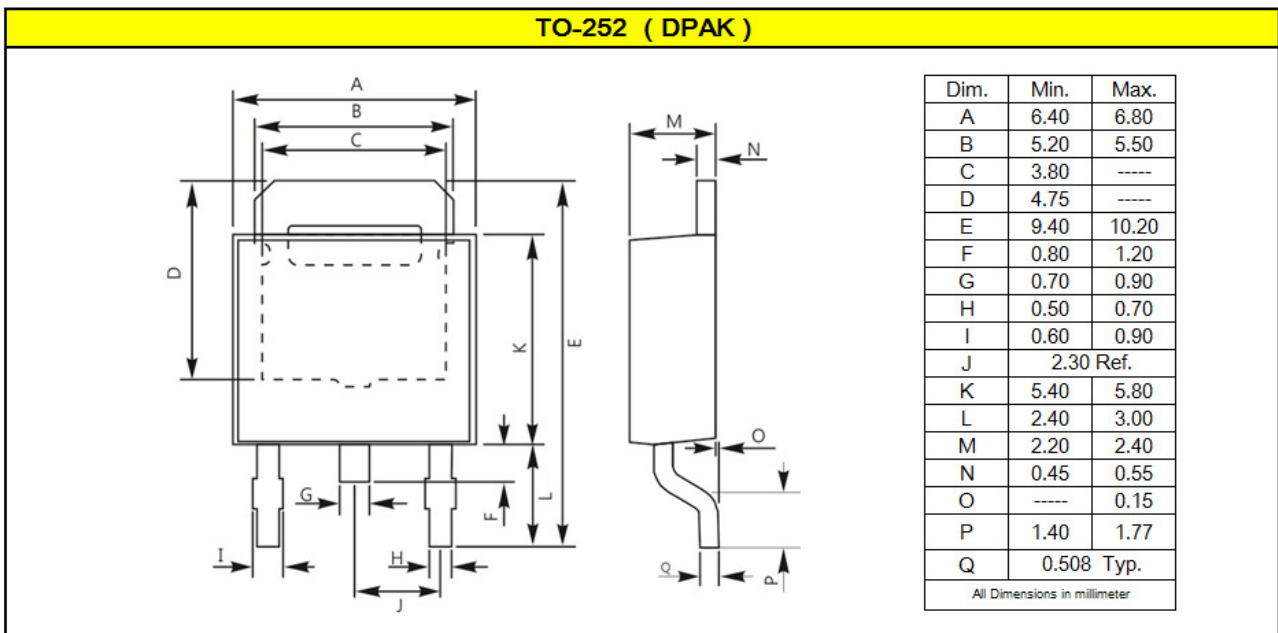
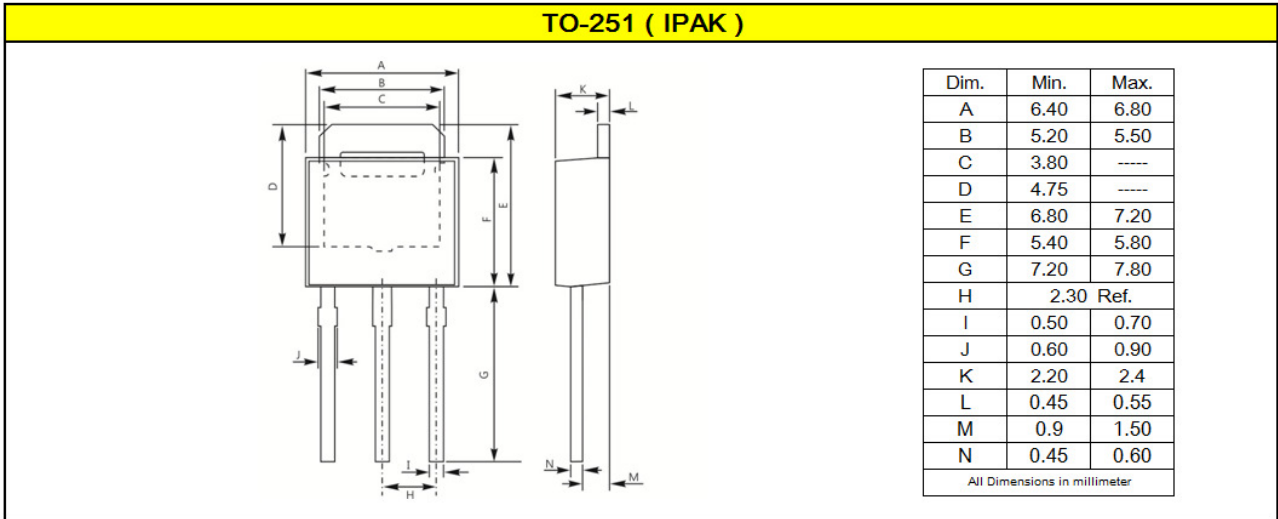

5. Ordering information

| Part Number | Package | Delivery mode |
|-------------|----------------|------------------------------|
| P20200E | TO-251 (I-PAK) | 75 pieces / tube |
| P20200D | TO-252 (D-PAK) | 2500 pcs / 13" diameter reel |

Note: For Halogen Free molding compound, add "H" suffix to part number above.

Mechanical

- Molder Plastic: UL Flammability Classification Rating 94V-0
- Device Weight : 0.01 ounces (0.3grams) - TO-251 (I-PAK)
0.01 ounces (0.3grams) - TO-252 (D-PAK)

PFC Device Corp reserves the right to make changes without further notice to any products herein. PFC Device Corp makes no warranty, representation or guarantee regarding the suitability of its products for any particular purpose, nor does PFC Device Corp assume any liability arising out of the application or use of any product or circuit, and specifically disclaims any and all liability, including without limitation special, consequential or incidental damages. "Typical" parameters which may be provided in PFC Device Corp data sheets and/or specifications can and do vary in different applications and actual performance may vary over time. All operating parameters, including "Typical" must be validated for each customer application by customer's technical experts. PFC Device Corp does not convey any license under its patent rights nor the rights of others. PFC Device Corp products are not designed, intended, or authorized for use as components in systems intended for surgical implant into the body, or other applications intended to support or sustain life, or for any other application in which the failure of the PFC Device Corp product could create a situation where personal injury or death may occur. Should Buyer purchase or use PFC Device Corp products for any such unintended or unauthorized application, Buyer shall indemnify and hold PFC Device Corp and its officers, employees, subsidiaries, affiliates, and distributors harmless against all claims, costs, damages, and expenses, and reasonable attorney fees arising out of, directly or indirectly, any claim of personal injury or death associated with such unintended or unauthorized use, even if such claim alleges that PFC Device Corp was negligent regarding the design or manufacture of the part.

