

HF RoHS Q2L Series - 3.3x3.3 QFN

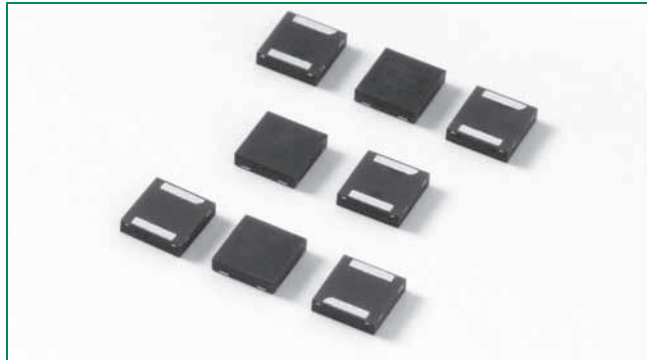

Description

Q2L Series 3.3x3.3 QFN are low capacitance SIDACTor® devices designed to protect high density broadband equipment from damaging overvoltage transients.

The series provides a low profile, chip scale surface mount solution that enables broadband equipment to comply with global regulatory standards while limiting the impact to broadband signals and board space.

Features and Benefits

- Low profile
- Small footprint
- Low capacitance
- Low voltage overshoot
- Low on-state voltage
- Does not degrade with use
- Fails short circuit when surged in excess of ratings

Applicable Global Standards

- TIA-968-A
- TIA-968-B
- ITU K.20/21 Enhanced Level
- ITU K.20/21 Basic Level
- GR 1089 Intra-building
- IEC 61000-4-5
- YD/T 1082
- YD/T 993
- YD/T 950
- GR 1089 Inter-building

Agency Approvals

Agency	Agency File Number
	E133083

Pinout Designation

Not Applicable

Schematic Symbol



Electrical Characteristics

Part Number	Marking	V_{DRM} @ $I_{DRM} = 5\mu A$	V_s @ 100V/ μs	I_H	I_s	I_T	$V_T @ I_T = 2.2 \text{ Amps}$	Capacitance @ 1MHz, 2V bias	
		V min	V max	mA min	mA max	A max	V max	pF min	pF max
P0080Q22CLRP	P-8C	6	25	50	800	2.2	5	35	75
P0300Q22CLRP	P03C	25	40	50	800	2.2	5	25	45
P0640Q22CLRP	P06C	58	77	150	800	2.2	5	55	85
P0720Q22CLRP	P07C	65	88	150	800	2.2	5	50	75
P0900Q22CLRP	P09C	75	98	150	800	2.2	5	45	70
P1100Q22CLRP	P11C	90	130	150	800	2.2	5	45	70
P1300Q22CLRP	P13C	120	160	150	800	2.2	5	40	60
P1500Q22CLRP	P15C	140	180	150	800	2.2	5	35	55
P1800Q22CLRP	P18C	170	220	150	800	2.2	5	35	50
P2300Q22CLRP	P23C	190	260	150	800	2.2	5	30	50
P2600Q22CLRP	P26C	220	300	150	800	2.2	5	30	45
P3100Q22CLRP	P31C	275	350	150	800	2.2	5	30	45
P3500Q22CLRP	P35C	320	400	150	800	2.2	5	25	40

Notes:
- Absolute maximum ratings measured at $T_a = 25^\circ C$ (unless otherwise noted).
- Devices are bi-directional (unless otherwise noted).

Surge Ratings

Series	I_{pp}					I_{TSM}	di/dt
	2x10 μ s	1.2x50 μ s/8x20 μ s	10x160 μ s	10x560 μ s	10x1000 μ s	50 / 60 Hz	Amps/ μ s max
C	500	400	200	150	100	30	500

Notes:
 - Peak pulse current rating (I_{pp}) is repetitive and guaranteed for the life of the product.
 - I_{pp} ratings applicable over temperature range of -40°C to +85°C
 - The device must initially be in thermal equilibrium with -40°C $\leq T_J \leq$ +150°C

Thermal Considerations

Package	Symbol	Parameter	Value	Unit
3.3 x 3.3 0FN 	T_J	Operating Junction Temperature Range	-40 to +150	°C
	T_S	Storage Temperature Range	-65 to +150	°C
	$R_{\theta JA}$	Thermal Resistance: Junction to Ambient	120	°C/W

V-I Characteristics

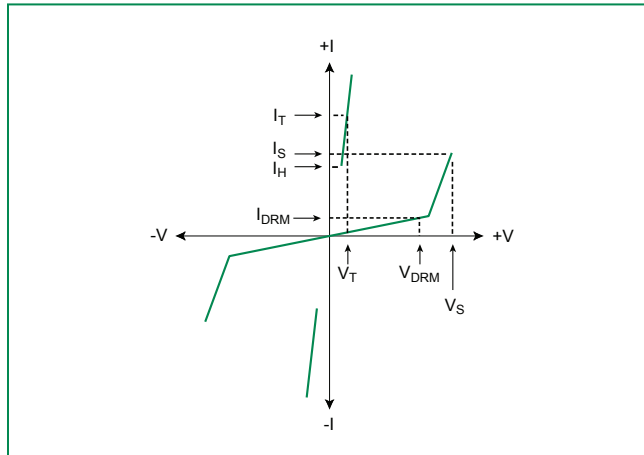

$t_r \times t_d$ Pulse Waveform

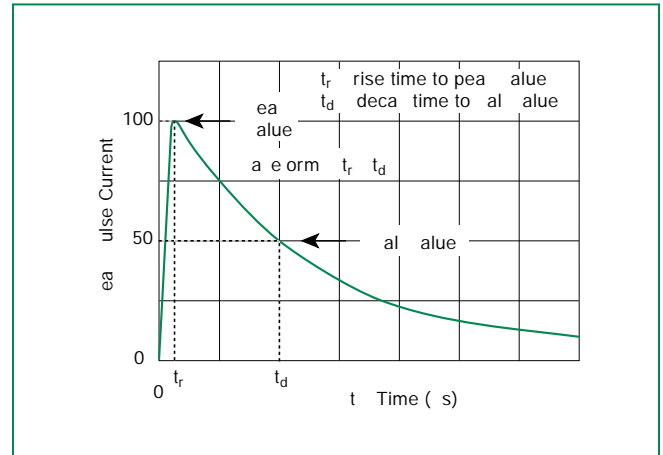

Normalized V_S Change vs. Junction Temperature

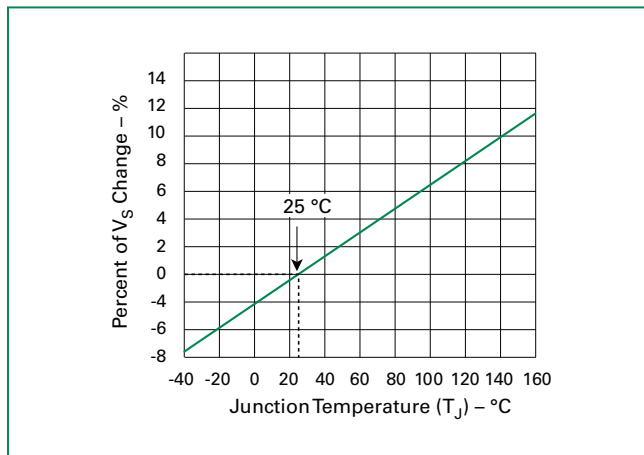

Normalized DC Holding Current vs. Case Temperature

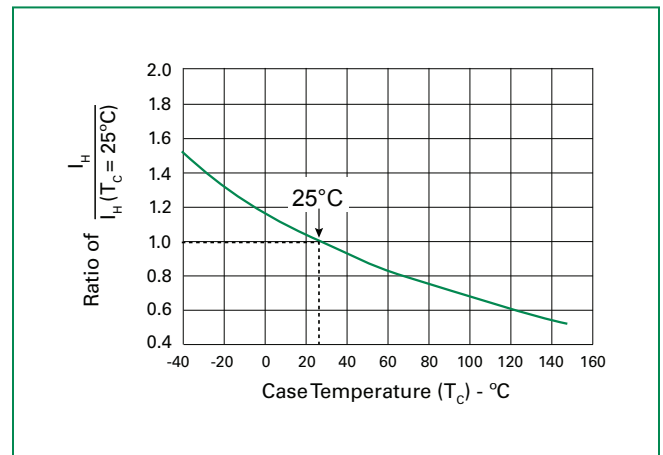

Soldering Parameters

Reflow Condition		Pb-Free assembly (see Fig. 1)
Pre Heat	- Temperature Min ($T_{s(min)}$)	+150°C
	- Temperature Max ($T_{s(max)}$)	+200°C
	- Time (Min to Max) (t_s)	60-180 secs.
Average ramp up rate (Liquidus Temp (T_L) to peak)		3°C/sec. Max.
$T_{s(max)}$ to T_L - Ramp-up Rate		3°C/sec. Max.
Reflow	- Temperature (T_L) (Liquidus)	+217°C
	- Temperature (t_L)	60-150 secs.
Peak Temp (T_p)		+260(+0/-5)°C
Time within 5°C of actual Peak Temp (t_p)		30 secs. Max.
Ramp-down Rate		6°C/sec. Max.
Time 25°C to Peak Temp (T_p)		8 min. Max.
Do not exceed		+260°C

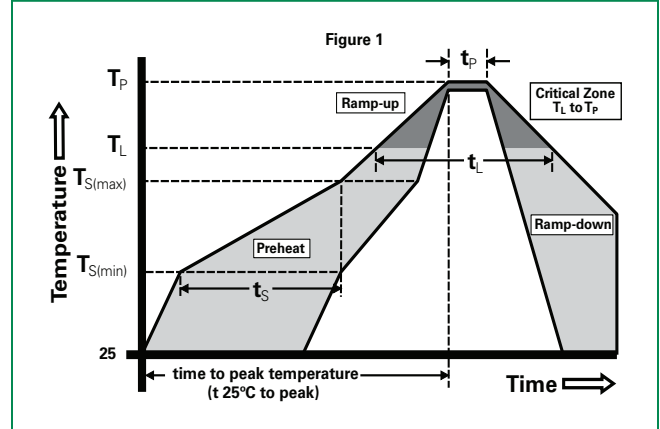

Physical Specifications

Lead Material	Copper Alloy
Terminal Finish	100% Matte-Tin Plated
Body Material	UL recognized epoxy meeting flammability classification 94V-0

Environmental Specifications

High Temp Voltage Blocking	80% Rated V_{DRM} ($V_{AC Peak}$) +125°C or +150°C, 504 or 1008 hrs. MIL-STD-750 (Method 1040) JEDEC, JESD22-A-101
Temp Cycling	-65°C to +150°C, 15 min. dwell, 10 up to 100 cycles. MIL-STD-750 (Method 1051) EIA/JEDEC, JESD22-A104
Biased Temp & Humidity	52 V_{DC} (+85°C) 85%RH, 504 up to 1008 hrs. EIA/JEDEC, JESD22-A-101
High Temp Storage	+150°C 1008 hrs. MIL-STD-750 (Method 1031) JEDEC, JESD22-A-101
Low Temp Storage	-65°C, 1008 hrs.
Thermal Shock	0°C to +100°C, 5 min. dwell, 10 sec. transfer, 10 cycles. MIL-STD-750 (Method 1056) JEDEC, JESD22-A-106
Resistance to Solder Heat	+260°C, 30 secs. MIL-STD-750 (Method 2031)
Moisture Sensitivity Level	85%RH, +85°C, 168 hrs., 3 reflow cycles (+260°C Peak). JEDEC-J-STD-020, Level 1

Dimensions — 3.3x3.3 QFN

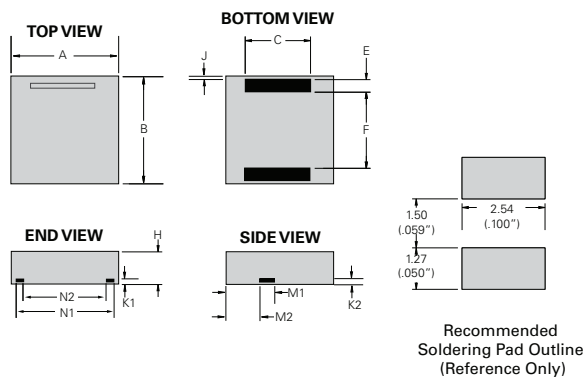

Dimensions	Inches		Millimeters	
	Min	Max	Min	Max
A	0.126	0.134	3.200	3.400
B	0.126	0.134	3.200	3.400
C	0.075	0.083	1.900	2.100
E	0.011	0.019	0.285	0.485
F	0.088	0.096	2.230	2.430
H	0.035	0.043	0.900	1.100
J	0.000	0.008	0.000	0.200
K1	0.004	0.012	0.100	0.300
K2	0.004	0.012	0.100	0.300
M1	0.063	0.071	1.610	1.810
M2	0.045	0.053	1.153	1.353
N1	0.095	0.103	2.420	2.620
N2	0.082	0.090	2.080	2.280

Part Numbering

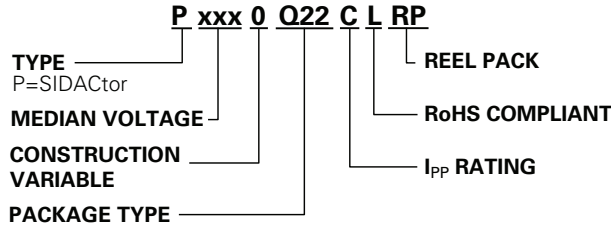

Part Marking

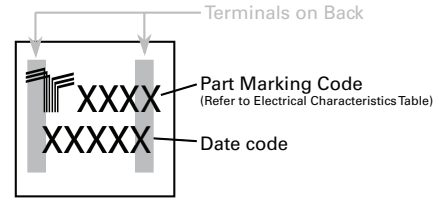

Packing Options

Package Type	Description	Quantity	Added Suffix	Industry Standard
Q22	3.3x3.3 QFN Tape and Reel Pack	5000	RP	EIA-481-D

Tape and Reel Specifications — 3.3x3.3 QFN

Reel Dimension

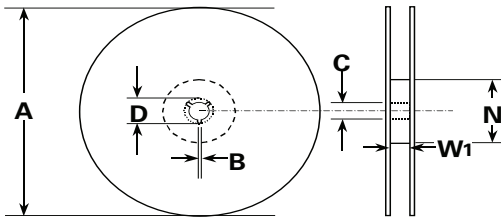

Tape Leader and Trailer Dimensions

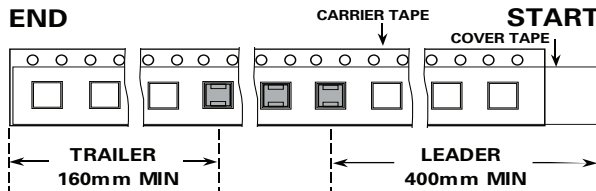

Tape Dimension Items

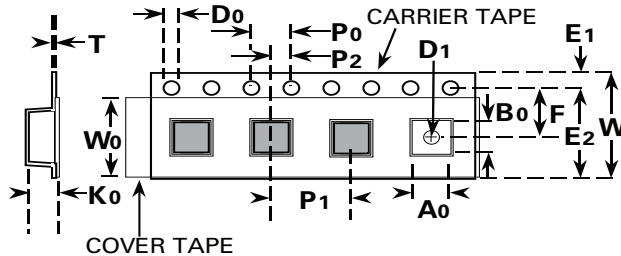

Symbols	Description	Inches		Millimeters	
		Min	Max	Min	Max
A	Reel Diameter	N/A	12.992	N/A	330.0
B	Drive Spoke Width	0.059	N/A	1.50	N/A
C	Arbor Hole Diameter	0.504	0.531	12.80	13.50
D	Drive Spoke Diameter	0.795	N/A	20.20	N/A
N	Hub Diameter	1.969	N/A	50.00	N/A
W ₁	Reel Inner Width at Hub	0.488	0.567	12.40	14.40
A ₀	Pocket Width at Bottom	0.138	0.146	3.50	3.70
B ₀	Pocket Length at Bottom	0.138	0.146	3.50	3.70
D ₀	Feed Hole Diameter	0.059	0.063	1.50	1.60
D ₁	Pocket Hole Diameter	0.059	N/A	1.50	N/A
E ₁	Feed Hole Position 1	0.065	0.073	1.65	1.85
E ₂	Feed Hole Position 2	0.400	0.408	10.15	10.35
F	Feed Hole Center - Pocket Hole Center 2	0.215	0.219	5.45	5.55
K ₀	Pocket Depth	0.039	0.051	1.00	1.30
P ₀	Feed Hole Pitch	0.153	0.161	3.90	4.10
P ₁	Component Spacing	0.311	0.319	7.90	8.10
P ₂	Feed Hole Center - Pocket Hole Center 1	0.077	0.081	1.90	2.05
T	Carrier Tape Thickness	0.010	0.014	0.25	0.35
W	Embossed Carrier Tape Width	0.453	0.484	11.50	12.30
W ₀	Cover Tape Width	0.358	0.366	9.10	9.30