

RoHS SIDACtor® Multiport Series - MS-013



Agency Approvals

| Agency | Agency File Number |
|--------|--------------------|
| | E133083 |

Pinout Designation

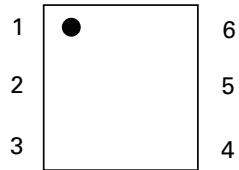

Schematic Symbol

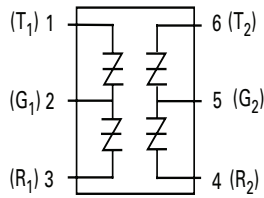

Description

SIDACtor® Multiport Series MS-013 are designed to protect baseband equipment from overvoltage transients.

Targeted for voice through DS-1 applications, the series provides a dual port surface mount solution that enables equipment to comply with various global regulatory standards.

Features and Benefits

- Low voltage overshoot
- Low on-state voltage
- Does not degrade with use
- Replaces four discrete components
- Fails short circuit when surged in excess of ratings
- Low Capacitance

Applicable Global Standards

- TIA-968-A
- TIA-968-B
- ITU K.20/21 Enhanced Level*
- ITU K.20/21 Basic Level
- GR 1089 Inter-building*
- GR 1089 Intra-building
- IEC 61000-4-5
- YD/T 1082
- YD/T 993
- YD/T 950

*A-rated parts require series resistance

Electrical Characteristics

| Part Number | Marking | V_{DRM} @ $I_{DRM}=5\mu A$ | V_S @ 100V/ μs | V_{DRM} @ $I_{DRM}=5\mu A$ | V_S @ 100V/ μs | V_T @ $I_T=2.2$ Amps | I_H | I_S | I_T | Capacitance |
|-------------|---------|---------------------------------|--------------------------|---------------------------------|--------------------------|---------------------------|--------|--------|-------|------------------------------|
| | | V min | V max | V min | V max | V max | mA min | mA max | A max | |
| | | Pins 1-2, 3-2, 4-5, 6-5 | | Pins 1-3, 4-6 | | Pins 1-2, 3-2, 4-5, 6-5 | | | | |
| P0084UALxx | P0084UA | 6 | 25 | 12 | 50 | 4 | 50 | 800 | 2.2 | See Capacitance Values Table |
| P0304UALxx | P0304UA | 25 | 40 | 50 | 80 | 4 | 50 | 800 | 2.2 | |
| P0644UALxx | P0644UA | 58 | 77 | 116 | 154 | 4 | 150 | 800 | 2.2 | |
| P0724UALxx | P0724UA | 65 | 88 | 130 | 176 | 4 | 150 | 800 | 2.2 | |
| P0904UALxx | P0904UA | 75 | 98 | 150 | 196 | 4 | 150 | 800 | 2.2 | |
| P1104UALxx | P1104UA | 90 | 130 | 180 | 260 | 4 | 150 | 800 | 2.2 | |
| P1304UALxx | P1304UA | 120 | 160 | 240 | 320 | 4 | 150 | 800 | 2.2 | |
| P1504UALxx | P1504UA | 140 | 180 | 280 | 360 | 4 | 150 | 800 | 2.2 | |

Table continues on next page.

Electrical Characteristics (continued)

| Part Number | Marking | V_{DRM} @ $I_{DRM} = -5\mu A$ | V_S @ 100V/ μs | V_{DRM} @ $I_{DRM} = -5\mu A$ | V_S @ 100V/ μs | V_T @ $I_T = 2.2$ Amps | I_H | I_S | I_T | Capacitance |
|-------------|---------|------------------------------------|--------------------------|------------------------------------|--------------------------|-----------------------------|--------|--------|-------|------------------------------------|
| | | V min | V max | V min | V max | V max | mA min | mA max | A max | |
| | | Pins 1-2, 3-2, 4-5, 6-5 | | Pins 1-3, 4-6 | | Pins 1-2, 3-2, 4-5, 6-5 | | | | |
| P1804UALxx | P1804UA | 170 | 220 | 340 | 440 | 4 | 150 | 800 | 2.2 | See Capacitance Values Table |
| P2304UALxx | P2304UA | 190 | 260 | 380 | 520 | 4 | 150 | 800 | 2.2 | |
| P2604UALxx | P2604UA | 220 | 300 | 440 | 600 | 4 | 150 | 800 | 2.2 | |
| P3104UALxx | P3104UA | 275 | 350 | 550 | 700 | 4 | 150 | 800 | 2.2 | |
| P3504UALxx | P3504UA | 320 | 400 | 640 | 800 | 4 | 150 | 800 | 2.2 | |
| P0084UCLxx | P0084UC | 6 | 25 | 12 | 50 | 4 | 50 | 800 | 2.2 | |
| P0304UCLxx | P0304UC | 25 | 40 | 50 | 80 | 4 | 50 | 800 | 2.2 | |
| P0644UCLxx | P0644UC | 58 | 77 | 116 | 154 | 4 | 150 | 800 | 2.2 | |
| P0724UCLxx | P0724UC | 65 | 88 | 130 | 176 | 4 | 150 | 800 | 2.2 | |
| P0904UCLxx | P0904UC | 75 | 98 | 150 | 196 | 4 | 150 | 800 | 2.2 | |
| P1104UCLxx | P1104UC | 90 | 130 | 180 | 260 | 4 | 150 | 800 | 2.2 | |
| P1304UCLxx | P1304UC | 120 | 160 | 240 | 320 | 4 | 150 | 800 | 2.2 | |
| P1504UCLxx | P1504UC | 140 | 180 | 280 | 360 | 4 | 150 | 800 | 2.2 | |
| P1804UCLxx | P1804UC | 170 | 220 | 340 | 440 | 4 | 150 | 800 | 2.2 | |
| P2304UCLxx | P2304UC | 190 | 260 | 380 | 520 | 4 | 150 | 800 | 2.2 | |
| P2604UCLxx | P2604UC | 220 | 300 | 440 | 600 | 4 | 150 | 800 | 2.2 | |
| P3104UCLxx | P3104UC | 275 | 350 | 550 | 700 | 4 | 150 | 800 | 2.2 | |
| P3504UCLxx | P3504UC | 320 | 400 | 640 | 800 | 4 | 150 | 800 | 2.2 | |

Notes:

- Absolute maximum ratings measured at $T_A = +25^\circ C$ (unless otherwise noted).
- Devices are bi-directional
- **XX** = Part Number Suffix: 'TP' (Tube Pack) or 'RP' (Reel Pack).

Capacitance Values

| Part Number | Pin 1-2 / 3-2 (4-5 / 6-5) Tip-Ground, Ring-Ground | | Pin 1-3 (4-6) Tip-Ring | |
|-------------|--|--------|---------------------------|--------|
| | pF min | pF max | pF min | pF max |
| P0084UALxx | 25 | 155 | 15 | 90 |
| P0304UALxx | 15 | 140 | 10 | 90 |
| P0644UALxx | 40 | 60 | 20 | 35 |
| P0724UALxx | 35 | 60 | 20 | 35 |
| P0904UALxx | 35 | 55 | 20 | 30 |
| P1104UALxx | 30 | 50 | 15 | 30 |
| P1304UALxx | 25 | 45 | 15 | 25 |
| P1504UALxx | 25 | 40 | 15 | 25 |
| P1804UALxx | 25 | 35 | 10 | 20 |
| P2304UALxx | 25 | 35 | 10 | 20 |
| P2604UALxx | 20 | 35 | 10 | 20 |
| P3104UALxx | 20 | 35 | 10 | 20 |
| P3504UALxx | 20 | 35 | 10 | 20 |
| P0084UCLxx | 35 | 285 | 20 | 165 |
| P0304UCLxx | 25 | 250 | 10 | 145 |
| P0644UCLxx | 55 | 155 | 30 | 90 |
| P0724UCLxx | 50 | 145 | 25 | 85 |
| P0904UCLxx | 45 | 135 | 25 | 80 |
| P1104UCLxx | 45 | 115 | 25 | 65 |
| P1304UCLxx | 40 | 105 | 20 | 60 |
| P1504UCLxx | 35 | 95 | 20 | 55 |
| P1804UCLxx | 35 | 90 | 15 | 50 |
| P2604UCLxx | 30 | 85 | 15 | 50 |
| P3104UCLxx | 30 | 80 | 15 | 45 |
| P3504UCLxx | 25 | 75 | 15 | 45 |

Surge Ratings

| Series | I_{PP} | | | | | | | | | I_{TSM} 50/60 Hz | di/dt A/ μ s max |
|--------|--|--|--|--|--|--|--|--|---|-----------------------|-------------------------|
| | 0.2x310 ¹ 0.5x700 ² | 2x10 ¹ 2x10 ² | 8x20 ¹ 1.2x50 ² | 10x160 ¹ 10x160 ² | 10x560 ¹ 10x560 ² | 5x320 ¹ 9x720 ² | 10x360 ¹ 10x360 ² | 10x1000 ¹ 10x1000 ² | 5x310 ¹ 10x700 ² | | |
| | A min | A min | A min | A min | A min | A min | A min | A min | A min | | |
| A | 20 | 150 | 150 | 90 | 50 | 75 | 75 | 45 | 75 | 20 | 500 |
| C | 50 | 500 | 400 | 200 | 150 | 200 | 175 | 100 | 200 | 30 | 500 |

Notes:

- 1 Current waveform in μ s
- 2 Voltage waveform in μ s
- Peak pulse current rating (I_{pp}) is repetitive and guaranteed for the life of the product.
- I_{pp} ratings applicable over temperature range of -40°C to +85°C
- The device must initially be in thermal equilibrium with -40°C $\leq T_J \leq$ +150°C

Thermal Considerations

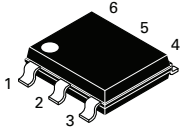
| Package | Symbol | Parameter | Value | Unit |
|---|-----------------|---|-------------|------|
|  Modified MS-013 | T_J | Operating Junction Temperature Range | -40 to +150 | °C |
| | T_S | Storage Temperature Range | -65 to +150 | °C |
| | $R_{\theta JA}$ | Thermal Resistance: Junction to Ambient | 60 | °C/W |

V-I Characteristics

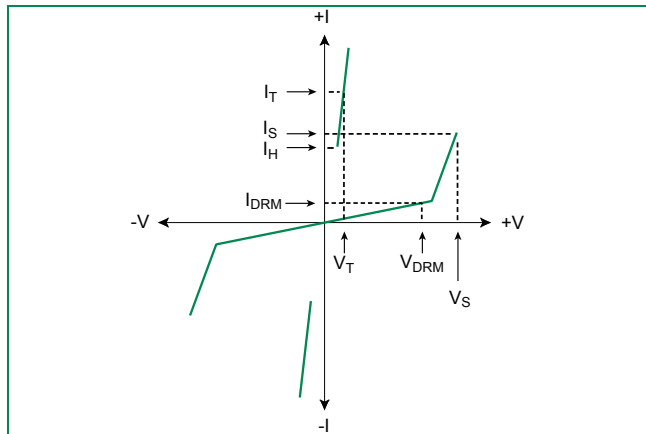

$t_r \times t_d$ Pulse Waveform

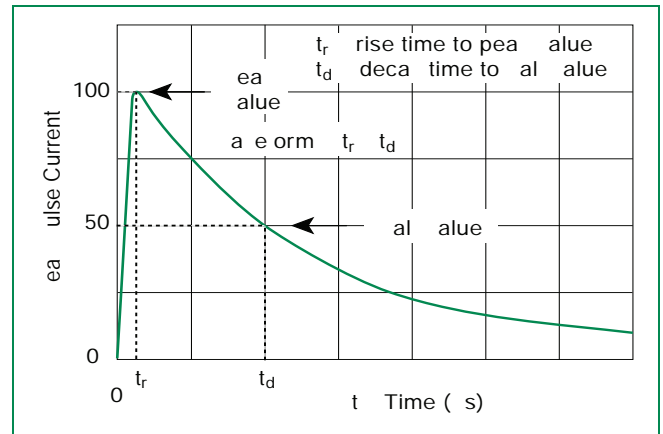

Normalized V_S Change vs. Junction Temperature

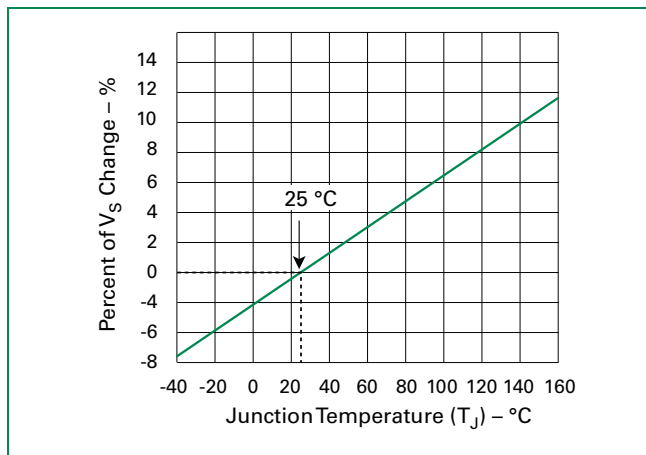

Normalized DC Holding Current vs. Case Temperature

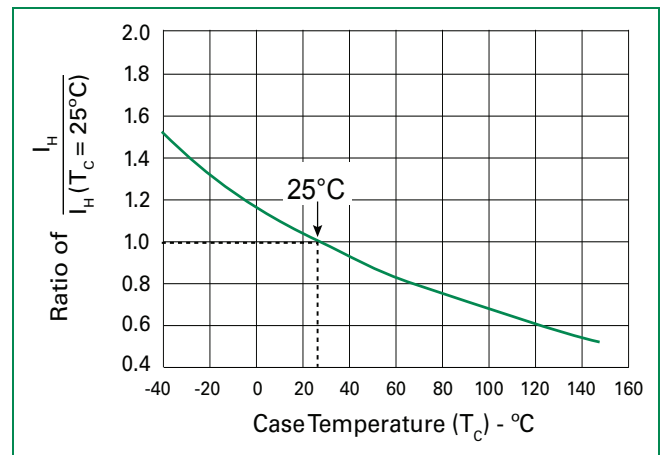

Soldering Parameters

| | | |
|---|-----------------------------------|-------------------------------|
| Reflow Condition | | Pb-Free assembly (see Fig. 1) |
| Pre Heat | -Temperature Min ($T_{s(min)}$) | +150°C |
| | -Temperature Max ($T_{s(max)}$) | +200°C |
| | -Time (Min to Max) (t_s) | 60-180 secs. |
| Average ramp up rate (LiquidusTemp (T_L) to peak) | | 3°C/sec. Max. |
| $T_{s(max)}$ to T_L - Ramp-up Rate | | 3°C/sec. Max. |
| Reflow | -Temperature (T_L) (Liquidus) | +217°C |
| | -Temperature (t_L) | 60-150 secs. |
| Peak Temp (T_p) | | +260(+0/-5)°C |
| Time within 5°C of actual Peak Temp (t_p) | | 30 secs. Max. |
| Ramp-down Rate | | 6°C/sec. Max. |
| Time 25°C to Peak Temp (T_p) | | 8 min. Max. |
| Do not exceed | | +260°C |

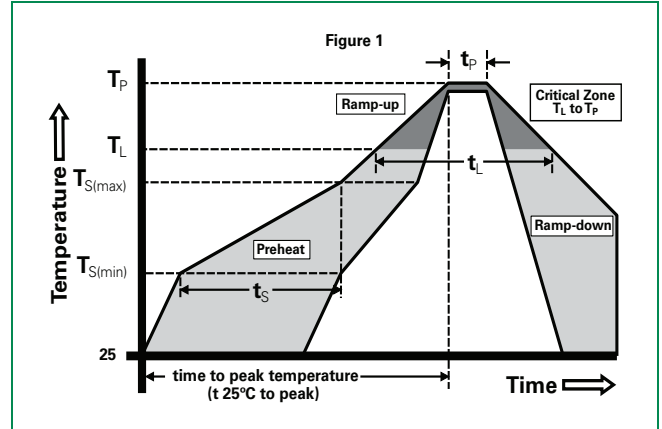

Physical Specifications

| | |
|------------------------|---|
| Lead Material | Copper Alloy |
| Terminal Finish | 100% Matte-Tin Plated |
| Body Material | UL recognized epoxy meeting flammability classification 94V-0 |

Environmental Specifications

| | |
|---|---|
| High Temp Voltage Blocking | 80% Rated V_{DRM} (V_{AC} Peak) +125°C or +150°C, 504 or 1008 hrs. MIL-STD-750 (Method 1040) JEDEC, JESD22-A-101 |
| Temp Cycling | -65°C to +150°C, 15 min. dwell, 10 up to 100 cycles. MIL-STD-750 (Method 1051) EIA/JEDEC, JESD22-A104 |
| Biased Temp & Humidity | 52 V_{DC} (+85°C) 85%RH, 504 up to 1008 hrs. EIA/JEDEC, JESD22-A-101 |
| High Temp Storage | +150°C 1008 hrs. MIL-STD-750 (Method 1031) JEDEC, JESD22-A-101 |
| Low Temp Storage | -65°C, 1008 hrs. |
| Thermal Shock | 0°C to +100°C, 5 min. dwell, 10 sec. transfer, 10 cycles. MIL-STD-750 (Method 1056) JEDEC, JESD22-A-106 |
| Autoclave (Pressure Cooker Test) | +121°C, 100%RH, 2atm, 24 up to 168 hrs. EIA/JEDEC, JESD22-A-102 |
| Resistance to Solder Heat | +260°C, 30 secs. MIL-STD-750 (Method 2031) |
| Moisture Sensitivity Level | 85%RH, +85°C, 168 hrs., 3 reflow cycles (+260°C Peak). JEDEC-J-STD-020, Level 1 |

Part Numbering

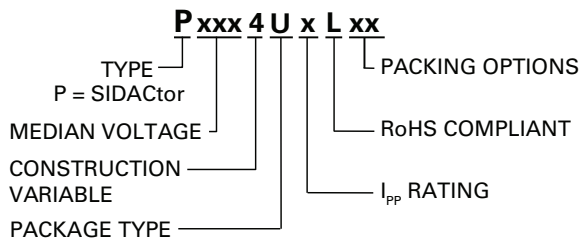

Part Marking

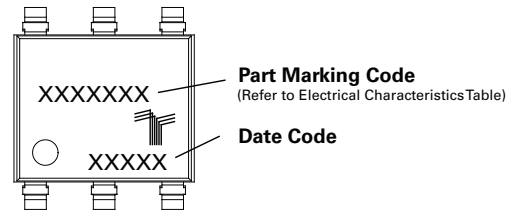

Dimensions — MS-013

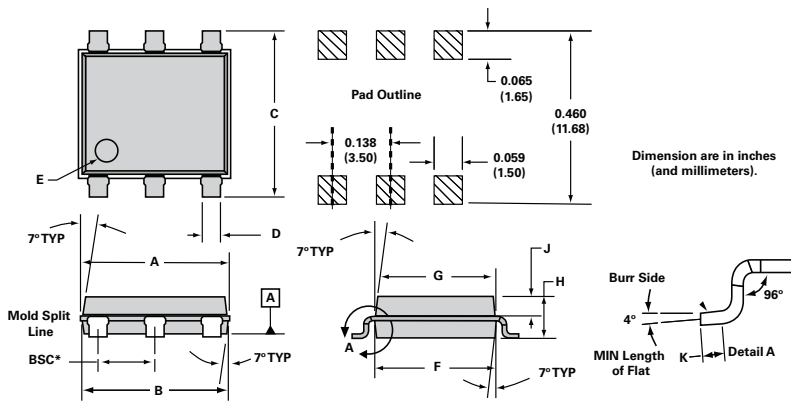

| Dimensions | Inches | | Millimeters | |
|-------------|--------|-------|-------------|-------|
| | Min | Max | Min | Max |
| A | 0.360 | 0.364 | 9.14 | 9.25 |
| B | 0.352 | 0.356 | 8.94 | 9.04 |
| C | 0.400 | 0.412 | 10.16 | 10.46 |
| D | 0.043 | 0.045 | 1.09 | 1.13 |
| E | 0.047 | 0.055 | 1.19 | 1.40 |
| F | 0.293 | 0.297 | 7.44 | 7.54 |
| G | 0.289 | 0.293 | 7.34 | 7.44 |
| H | 0.089 | 0.093 | 2.26 | 2.36 |
| J | 0.041 | 0.049 | 1.04 | 1.24 |
| K | 0.020 | — | 0.51 | — |
| BSC* | 0.133 | 0.143 | 3.38 | 3.63 |

* BSC = Basic Spacing between Centers

Packing Options

| Package Type | Description | Quantity | Added Suffix | Industry Standard |
|--------------|--|----------------------|--------------|-------------------|
| U | Modified MS-013 6-pin Tape and Reel Pack | 1500 | RP | EIA-481-D |
| | Modified MS-013 6-pin Tube Pack | 500 (50 per tube) | TP | N/A |

Tape and Reel Specification — MS-013

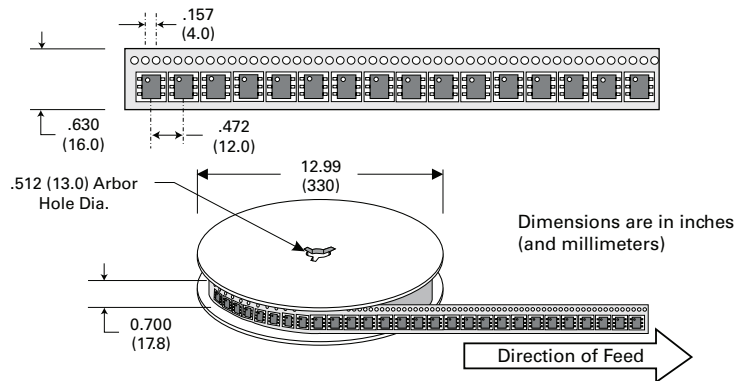

Tube Pack Specification — MS-013

