

Thyristor Surge Suppressors

**PxxxxLX Series
DO-15**

Thyristor Surge Suppressors -PxxxxLX Series

Description

DO-15 Series are designed to protect baseband equipment such as modems, line cards, CPE and DSL from damaging overvoltage transients.

The series provides a cost-effective through-hole solution that enables equipment to comply with global regulatory standards.



Features

Compared to surge suppression using other technologies, P Series devices offer absolute surge protection regardless of the surge current available and the rate of applied voltage (dv/dt). P Series devices:

- Cannot be damaged by voltage
- Eliminate hysteresis and heat dissipation typically found with clamping devices
- Eliminate voltage overshoot caused by fast-rising transients
- Are non-degenerative
- Will not fatigue
- Have low capacitance, making them ideal for high-speed transmission equipment

Part Number Code

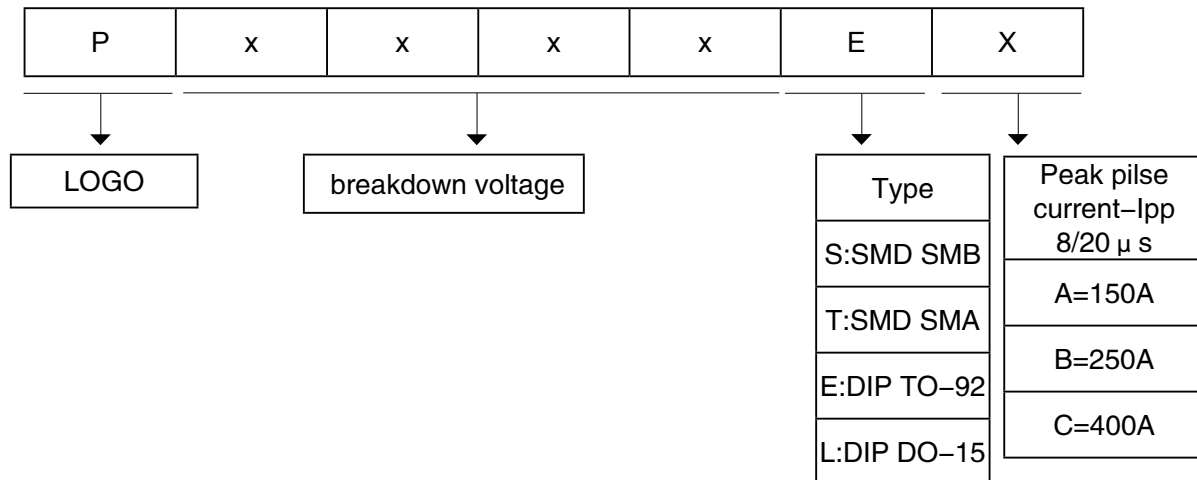

Electrical Characteristics

Type Number	VDRM	IDRM	VBO	IH	IS	IT	VT	CJ	
	V	μA	V	MA	MA	A	V	pFMin	pFMax
P0080LA	6	5	25	50	800	2.2	4	25	150
P0080LB	6	5	25	50	800	2.2	4	25	150
P0080LC	6	5	25	50	800	2.2	4	35	260
P0300LA	25	5	40	50	800	2.2	4	15	140
P0300LB	25	5	40	50	800	2.2	4	15	140
P0300LC	25	5	40	50	800	2.2	4	25	250
P0640LA	58	5	77	150	800	2.2	4	40	60
P0640LB	58	5	77	150	800	2.2	4	40	60
P0640LC	58	5	77	150	800	2.2	4	55	155
P0720LA	65	5	88	150	800	2.2	4	35	60
P0720LB	65	5	88	150	800	2.2	4	35	75
P0720LC	65	5	88	150	800	2.2	4	50	150
P0900LA	75	5	98	150	800	2.2	4	35	55
P0900LB	75	5	98	150	800	2.2	4	35	70
P0900LC	75	5	98	150	800	2.2	4	45	140
P1100LA	90	5	130	150	800	2.2	4	30	50
P1100LB	90	5	130	150	800	2.2	4	30	70
P1100LC	90	5	130	150	800	2.2	4	45	115
P1300LA	120	5	160	150	800	2.2	4	25	45
P1300LB	120	5	160	150	800	2.2	4	25	60
P1300LC	120	5	160	150	800	2.2	4	40	105
P1500LA	140	5	180	150	800	2.2	4	25	40
P1500LB	140	5	180	150	800	2.2	4	25	55
P1500LC	140	5	180	150	800	2.2	4	35	95
P1800LA	170	5	220	150	800	2.2	4	25	35
P1800LB	170	5	220	150	800	2.2	4	25	50
P1800LC	170	5	220	150	800	2.2	4	35	90
P2300LA	190	5	260	150	800	2.2	4	25	35
P2300LB	190	5	260	150	800	2.2	4	25	50
P2300LC	190	5	260	150	800	2.2	4	30	80
P2600LA	220	5	300	150	800	2.2	4	20	35
P2600LB	220	5	300	150	800	2.2	4	20	45
P2600LC	220	5	300	150	800	2.2	4	30	80
P3100LA	275	5	350	150	800	2.2	4	20	35
P3100LB	275	5	350	150	800	2.2	4	20	45
P3100LC	275	5	350	150	800	2.2	4	30	70
P3500LA	320	5	400	150	800	2.2	4	20	35
P3500LB	320	5	400	150	800	2.2	4	20	40
P3500LC	320	5	400	150	800	2.2	4	25	65

Notes:

Is: Switching Current – maximum current required to switch to on state

IDRM: Leakage Current – maximum peak off-state current measured at VDRM

IH: Holding Current – minimum current required to maintain on state

IPP: Peak Pulse Current – maximum rated peak impulse current

IT: On-state Current – maximum rated continuous on-state current

VDRM: Peak Off-state Voltage – maximum voltage that can be applied while maintaining off state

VT: On-state Voltage – maximum voltage measured at rated on-state current

Surge Ratings

SERIES	Peak Pulse Current-I _{pp} (A)				
	2/10μs	8/20μs	10/160μs	10/560μs	10/1000μs
A	200	150	100	60	50
B	250	250	150	100	80
C	500	400	200	120	100

Notes:

- Peak pulse current rating (I_{pp}) is repetitive and guaranteed for the life of the product.
- I_{pp} ratings applicable over temperature range of -40°C to +85°C
- 1 Current waveform in μs
- 2 Voltage waveform in μs
- The device must initially be in thermal equilibrium with -40°C ≤ T_j ≤ +150°C

V-I Characteristics

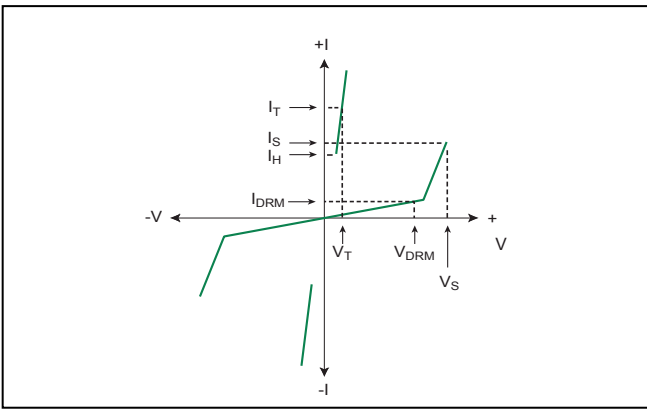

t_r x t_d Pulse Waveform

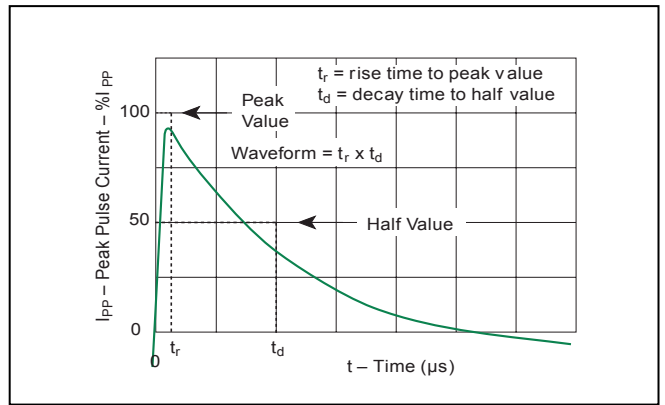

Normalized V_s Change vs. Junction Temperature

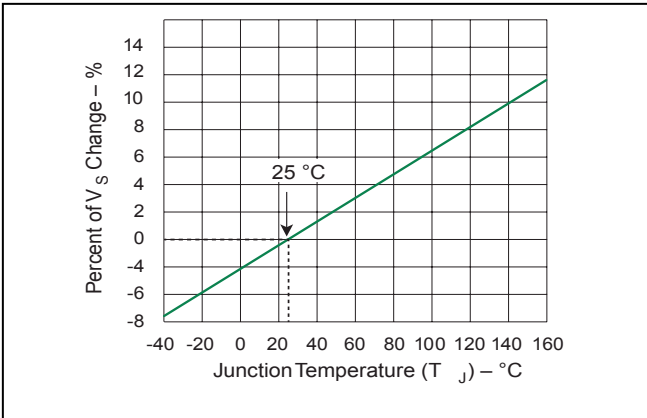

Normalized DC Holding Current vs. Case Temperature

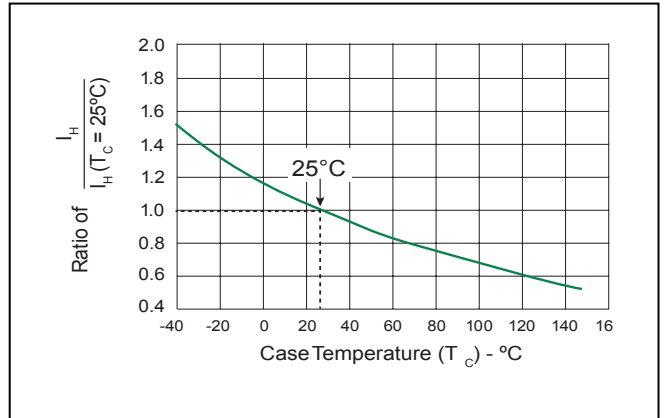

Thyristor Surge Suppressors - PxxxxLX Series

Thermal Considerations

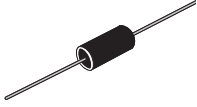
Package	Symbol	Parameter	Value	Unit
 DO-15	T_J	Operating Junction Temperature Range	-40 to +150	°C
	T_S	Storage Temperature Range	-65 to +150	°C
	$R_{\theta JA}$	Thermal Resistance: Junction to Ambient	60	°C/W

Soldering Parameters

Reflow Condition		Pb-Free assembly (see Fig. 1)
Pre Heat	- Temperature Min ($T_{s(min)}$)	+150°C
	- Temperature Max ($T_{s(max)}$)	+200°C
	- Time (Min to Max) (t_s)	60-180 secs.
Average ramp up rate (Liquidus Temp (T_L) to peak)		3°C/sec. Max.
$T_{s(max)}$ to T_L - Ramp-up Rate		3°C/sec. Max.
Reflow	- Temperature (T_L) (Liquidus)	+217°C
	- Temperature (t_L)	60-150 secs.
Peak Temp (T_p)		+260(+0/-5)°C
Time within 5°C of actual Peak Temp (t_p)		30 secs. Max.
Ramp-down Rate		6°C/sec. Max.
Time 25°C to Peak Temp (T)		8 min. Max.

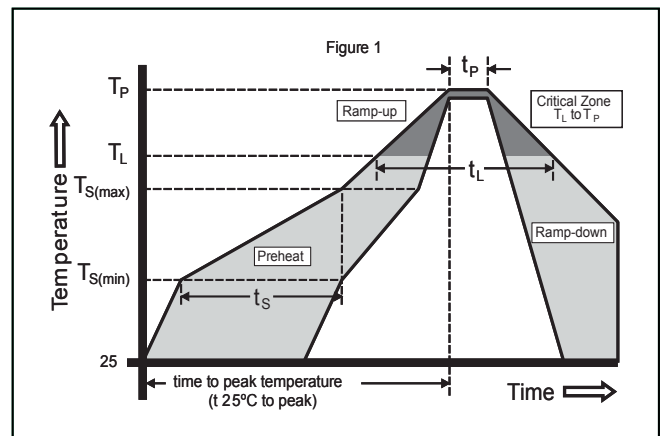

Thyristor Surge Suppressors -PxxxxLX Series

Physical Specifications

Lead Material	Copper Alloy
Terminal Finish	100% Matte-Tin Plated
Body Material	UL recognized epoxy meeting flammability classification 94V-0

Packing Options

Package Type	Description	Quantity	Added Suffix	Industry Standard
L	DO-15 Axial Tape & Reel	2000	RP	EIA-RS-296-D

Environmental Specifications

High Temp Voltage Blocking	80% Rated V_{DRM} (V_{AC} Peak) +125°C or +150°C, 504 or 1008 hrs. MIL-STD-750 (Method 1040) JEDEC, JESD22-A-101
Temp Cycling	-65°C to +150°C, 15 min. dwell, 10 up to 100 cycles. MIL-STD-750 (Method 1051) EIA/JEDEC, JESD22-A104
Biased Temp & Humidity	52 V_{DC} (+85°C) 85%RH, 504 up to 1008 hrs. EIA/JEDEC, JESD22-A-101
High Temp Storage	+150°C 1008 hrs. MIL-STD-750 (Method 1031) JEDEC, JESD22-A-101
Low Temp Storage	-65°C, 1008 hrs.
Thermal Shock	0°C to +100°C, 5 min. dwell, 10 sec. transfer, 10 cycles. MIL-STD-750 (Method 1056) JEDEC, JESD22-A-106
Autoclave (Pressure Cooker Test)	+121°C, 100%RH, 2atm, 24 up to 168 hrs. EIA/JEDEC, JESD22-A-102
Resistance to Solder Heat	+260°C, 30 secs. MIL-STD-750 (Method 2031)
Moisture Sensitivity Level	85%RH, +85°C, 168 hrs., 3 reflow cycles (+260°C Peak). JEDEC-J-STD-020, Level 1

Dimensions — DO-15

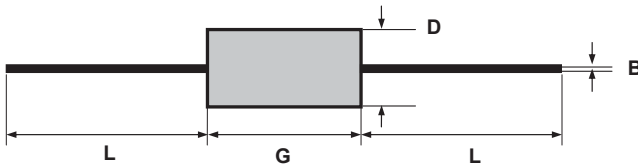

Dimension	Inches		Millimeters	
	MIN	MAX	MIN	MAX
B	0.028	0.034	0.711	0.864
D	0.12	0.14	3.048	3.556
G	0.235	0.27	5.969	6.858
L	1		25.4	

Tape and Reel Specification — DO-15

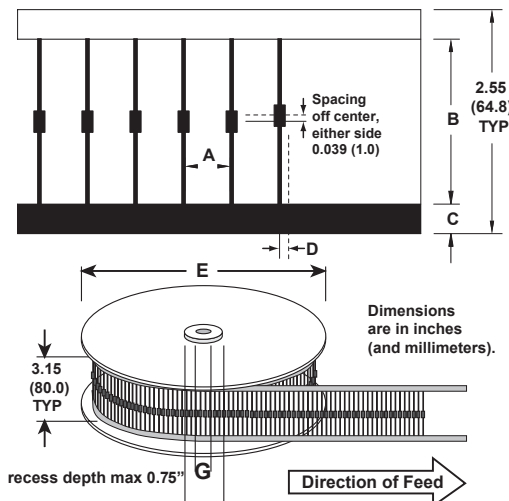

Symbols	Description	Inches	MM
A	Component Spacing (lead to lead)	0.200 ± 0.020"	5.08 ± 0.508
B	Inner Tape Pitch	2.062 ± 0.059"	52.37 ± 1.498
C	Tape Width	0.250"	6.35
D	Max. Off Alignment	0.048"	1.219
E	Reel Dimension	13"	330.2
F	Max. Hub Recess	3"	76.19
G	Max. Abor Hole	0.68"	17.27

RuiLongYuan Electronics Co., Ltd.

- Reproducing and modifying information of the document is prohibited without permission from Ruilongyuan International Inc.
- Ruilongyuan International Inc. reserves the rights to make changes of the content herein the document anytime without notification. Please refer to our website for the latest document.
- Ruilongyuan International Inc. disclaims any and all liability arising out of the application or use of any product including damages incidentally and consequentially occurred.
- Ruilongyuan International Inc. does not assume any and all implied warranties, including warranties of fitness for particular purpose, non-infringement and merchantability.
- Applications shown on the herein document are examples of standard use and operation. Customers are responsible in comprehending the suitable use in particular applications. Ruilongyuan International Inc. makes no representation or warranty that such applications will be suitable for the specified use without further testing or modification.
- The products shown herein are not designed and authorized for equipments requiring high level of reliability or relating to human life and for any applications concerning life-saving or life-sustaining, such as medical instruments, transportation equipment, aerospace machinery et cetera. Customers using or selling these products for use in such applications do so at their own risk and agree to fully indemnify Ruilongyuan International Inc. for any damages resulting from such improper use or sale.

Tel: +86-755-8290 8296

Fax: +86-755-8290 8002

E-mail: jack@ruilon.com