

**RoHS SIDACtor® Multiport Series - MS-013**



**Agency Approvals**

| Agency | Agency File Number |
|--------|--------------------|
|        | E133083            |

**Pinout Designation**

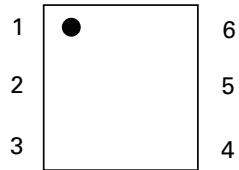

**Schematic Symbol**

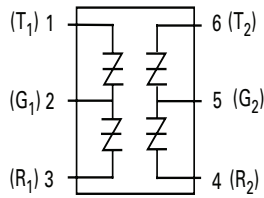

**Description**

SIDACtor® Multiport Series MS-013 are designed to protect baseband equipment from overvoltage transients.

Targeted for voice through DS-1 applications, the series provides a dual port surface mount solution that enables equipment to comply with various global regulatory standards.

**Features and Benefits**

- Low voltage overshoot
- Low on-state voltage
- Does not degrade with use
- Replaces four discrete components
- Fails short circuit when surged in excess of ratings
- Low Capacitance

**Applicable Global Standards**

- TIA-968-A
- TIA-968-B
- ITU K.20/21 Enhanced Level\*
- ITU K.20/21 Basic Level
- GR 1089 Inter-building\*
- GR 1089 Intra-building
- IEC 61000-4-5
- YD/T 1082
- YD/T 993
- YD/T 950

\*A-rated parts require series resistance

**Electrical Characteristics**

| Part Number | Marking | $V_{DRM}$<br>@ $I_{DRM}=5\mu A$ | $V_S$<br>@ $100V/\mu s$ | $V_{DRM}$<br>@ $I_{DRM}=5\mu A$ | $V_S$<br>@ $100V/\mu s$ | $V_T$<br>@ $I_T=2.2$ Amps | $I_H$  | $I_S$  | $I_T$ | Capacitance                  |
|-------------|---------|---------------------------------|-------------------------|---------------------------------|-------------------------|---------------------------|--------|--------|-------|------------------------------|
|             |         | V min                           | V max                   | V min                           | V max                   | V max                     | mA min | mA max | A max |                              |
|             |         | Pins 1-2, 3-2, 4-5, 6-5         |                         | Pins 1-3, 4-6                   |                         | Pins 1-2, 3-2, 4-5, 6-5   |        |        |       |                              |
| P0084UALxx  | P0084UA | 6                               | 25                      | 12                              | 50                      | 4                         | 50     | 800    | 2.2   | See Capacitance Values Table |
| P0304UALxx  | P0304UA | 25                              | 40                      | 50                              | 80                      | 4                         | 50     | 800    | 2.2   |                              |
| P0644UALxx  | P0644UA | 58                              | 77                      | 116                             | 154                     | 4                         | 150    | 800    | 2.2   |                              |
| P0724UALxx  | P0724UA | 65                              | 88                      | 130                             | 176                     | 4                         | 150    | 800    | 2.2   |                              |
| P0904UALxx  | P0904UA | 75                              | 98                      | 150                             | 196                     | 4                         | 150    | 800    | 2.2   |                              |
| P1104UALxx  | P1104UA | 90                              | 130                     | 180                             | 260                     | 4                         | 150    | 800    | 2.2   |                              |
| P1304UALxx  | P1304UA | 120                             | 160                     | 240                             | 320                     | 4                         | 150    | 800    | 2.2   |                              |
| P1504UALxx  | P1504UA | 140                             | 180                     | 280                             | 360                     | 4                         | 150    | 800    | 2.2   |                              |

Table continues on next page.

### Electrical Characteristics (continued)

| Part Number | Marking | $V_{DRM}$<br>@ $I_{DRM} = -5\mu A$ | $V_S$<br>@ 100V/ $\mu s$ | $V_{DRM}$<br>@ $I_{DRM} = -5\mu A$ | $V_S$<br>@ 100V/ $\mu s$ | $V_T$<br>@ $I_T = 2.2$ Amps | $I_H$  | $I_S$  | $I_T$ | Capacitance                        |
|-------------|---------|------------------------------------|--------------------------|------------------------------------|--------------------------|-----------------------------|--------|--------|-------|------------------------------------|
|             |         | V min                              | V max                    | V min                              | V max                    | V max                       | mA min | mA max | A max |                                    |
|             |         | Pins 1-2, 3-2, 4-5, 6-5            |                          | Pins 1-3, 4-6                      |                          | Pins 1-2, 3-2, 4-5, 6-5     |        |        |       |                                    |
| P1804UALxx  | P1804UA | 170                                | 220                      | 340                                | 440                      | 4                           | 150    | 800    | 2.2   | See<br>Capacitance<br>Values Table |
| P2304UALxx  | P2304UA | 190                                | 260                      | 380                                | 520                      | 4                           | 150    | 800    | 2.2   |                                    |
| P2604UALxx  | P2604UA | 220                                | 300                      | 440                                | 600                      | 4                           | 150    | 800    | 2.2   |                                    |
| P3104UALxx  | P3104UA | 275                                | 350                      | 550                                | 700                      | 4                           | 150    | 800    | 2.2   |                                    |
| P3504UALxx  | P3504UA | 320                                | 400                      | 640                                | 800                      | 4                           | 150    | 800    | 2.2   |                                    |
| P0084UCLxx  | P0084UC | 6                                  | 25                       | 12                                 | 50                       | 4                           | 50     | 800    | 2.2   |                                    |
| P0304UCLxx  | P0304UC | 25                                 | 40                       | 50                                 | 80                       | 4                           | 50     | 800    | 2.2   |                                    |
| P0644UCLxx  | P0644UC | 58                                 | 77                       | 116                                | 154                      | 4                           | 150    | 800    | 2.2   |                                    |
| P0724UCLxx  | P0724UC | 65                                 | 88                       | 130                                | 176                      | 4                           | 150    | 800    | 2.2   |                                    |
| P0904UCLxx  | P0904UC | 75                                 | 98                       | 150                                | 196                      | 4                           | 150    | 800    | 2.2   |                                    |
| P1104UCLxx  | P1104UC | 90                                 | 130                      | 180                                | 260                      | 4                           | 150    | 800    | 2.2   |                                    |
| P1304UCLxx  | P1304UC | 120                                | 160                      | 240                                | 320                      | 4                           | 150    | 800    | 2.2   |                                    |
| P1504UCLxx  | P1504UC | 140                                | 180                      | 280                                | 360                      | 4                           | 150    | 800    | 2.2   |                                    |
| P1804UCLxx  | P1804UC | 170                                | 220                      | 340                                | 440                      | 4                           | 150    | 800    | 2.2   |                                    |
| P2304UCLxx  | P2304UC | 190                                | 260                      | 380                                | 520                      | 4                           | 150    | 800    | 2.2   |                                    |
| P2604UCLxx  | P2604UC | 220                                | 300                      | 440                                | 600                      | 4                           | 150    | 800    | 2.2   |                                    |
| P3104UCLxx  | P3104UC | 275                                | 350                      | 550                                | 700                      | 4                           | 150    | 800    | 2.2   |                                    |
| P3504UCLxx  | P3504UC | 320                                | 400                      | 640                                | 800                      | 4                           | 150    | 800    | 2.2   |                                    |

Notes:

- Absolute maximum ratings measured at  $T_A = +25^\circ C$  (unless otherwise noted).
- Devices are bi-directional
- **XX** = Part Number Suffix: 'TP' (Tube Pack) or 'RP' (Reel Pack).

### Capacitance Values

| Part Number | Pin 1-2 / 3-2 (4-5 / 6-5)<br>Tip-Ground, Ring-Ground |        | Pin 1-3 (4-6)<br>Tip-Ring |        |
|-------------|--|--------|---------------------------|--------|
|             | pF min   | pF max | pF min                    | pF max |
| P0084UALxx  | 25   | 155    | 15                        | 90     |
| P0304UALxx  | 15   | 140    | 10                        | 90     |
| P0644UALxx  | 40   | 60     | 20                        | 35     |
| P0724UALxx  | 35   | 60     | 20                        | 35     |
| P0904UALxx  | 35   | 55     | 20                        | 30     |
| P1104UALxx  | 30   | 50     | 15                        | 30     |
| P1304UALxx  | 25   | 45     | 15                        | 25     |
| P1504UALxx  | 25   | 40     | 15                        | 25     |
| P1804UALxx  | 25   | 35     | 10                        | 20     |
| P2304UALxx  | 25   | 35     | 10                        | 20     |
| P2604UALxx  | 20   | 35     | 10                        | 20     |
| P3104UALxx  | 20   | 35     | 10                        | 20     |
| P3504UALxx  | 20   | 35     | 10                        | 20     |
| P0084UCLxx  | 35   | 285    | 20                        | 165    |
| P0304UCLxx  | 25   | 250    | 10                        | 145    |
| P0644UCLxx  | 55   | 155    | 30                        | 90     |
| P0724UCLxx  | 50   | 145    | 25                        | 85     |
| P0904UCLxx  | 45   | 135    | 25                        | 80     |
| P1104UCLxx  | 45   | 115    | 25                        | 65     |
| P1304UCLxx  | 40   | 105    | 20                        | 60     |
| P1504UCLxx  | 35   | 95     | 20                        | 55     |
| P1804UCLxx  | 35   | 90     | 15                        | 50     |
| P2604UCLxx  | 30   | 85     | 15                        | 50     |
| P3104UCLxx  | 30   | 80     | 15                        | 45     |
| P3504UCLxx  | 25   | 75     | 15                        | 45     |

**Surge Ratings**

| Series | $I_{PP}$                                     |  |  |  |  |  |  |  |   | $I_{TSM}$<br>50/60 Hz | di/dt<br>A/ $\mu$ s max |
|--------|--|--|--|--|--|--|--|--|---|-----------------------|-------------------------|
|        | 0.2x310 <sup>1</sup><br>0.5x700 <sup>2</sup> | 2x10 <sup>1</sup><br>2x10 <sup>2</sup> | 8x20 <sup>1</sup><br>1.2x50 <sup>2</sup> | 10x160 <sup>1</sup><br>10x160 <sup>2</sup> | 10x560 <sup>1</sup><br>10x560 <sup>2</sup> | 5x320 <sup>1</sup><br>9x720 <sup>2</sup> | 10x360 <sup>1</sup><br>10x360 <sup>2</sup> | 10x1000 <sup>1</sup><br>10x1000 <sup>2</sup> | 5x310 <sup>1</sup><br>10x700 <sup>2</sup> |                       |                         |
|        | A min  | A min                                  | A min                                    | A min                                      | A min                                      | A min                                    | A min                                      | A min  | A min                                     |                       |                         |
| A      | 20   | 150                                    | 150                                      | 90   | 50   | 75                                       | 75   | 45   | 75  | 20                    | 500                     |
| C      | 50   | 500                                    | 400                                      | 200  | 150  | 200                                      | 175  | 100  | 200                                       | 30                    | 500                     |

Notes:

- 1 Current waveform in  $\mu$ s
- 2 Voltage waveform in  $\mu$ s
- Peak pulse current rating ( $I_{pp}$ ) is repetitive and guaranteed for the life of the product.
- $I_{pp}$  ratings applicable over temperature range of -40°C to +85°C
- The device must initially be in thermal equilibrium with -40°C  $\leq T_J \leq$  +150°C

**Thermal Considerations**

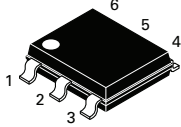
| Package  | Symbol          | Parameter                               | Value       | Unit |
|--|-----------------|---|-------------|------|
| <br>Modified MS-013 | $T_J$           | Operating Junction Temperature Range    | -40 to +150 | °C   |
|  | $T_S$           | Storage Temperature Range               | -65 to +150 | °C   |
|  | $R_{\theta JA}$ | Thermal Resistance: Junction to Ambient | 60          | °C/W |

**V-I Characteristics**

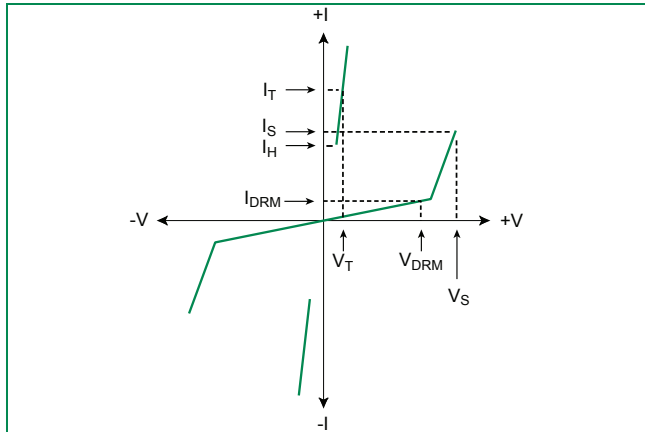

**$t_r \times t_d$  Pulse Waveform**

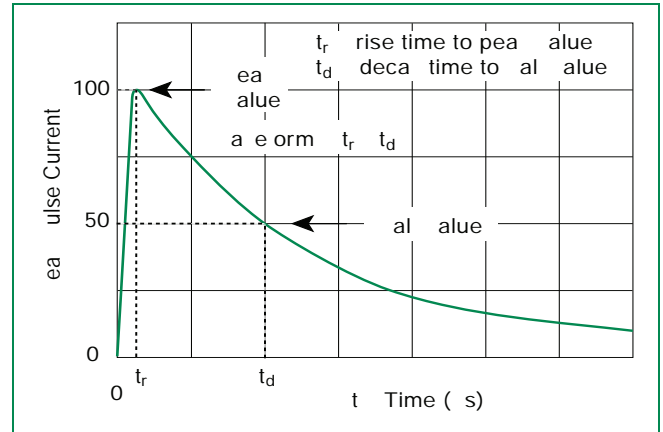

**Normalized  $V_S$  Change vs. Junction Temperature**

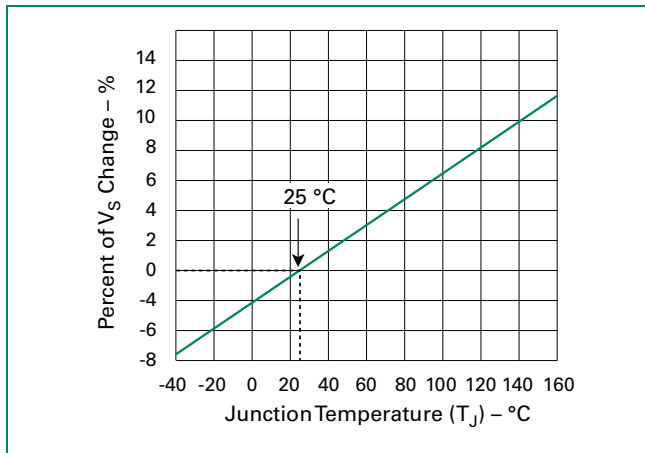

**Normalized DC Holding Current vs. Case Temperature**

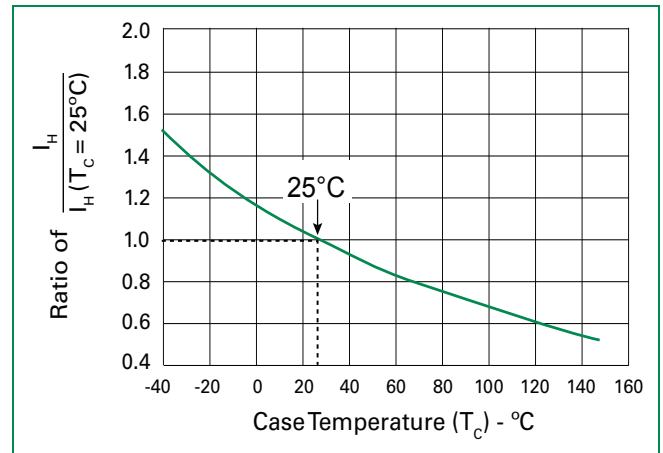

**Soldering Parameters**

|   |                                   |                               |
|---|-----------------------------------|-------------------------------|
| Reflow Condition                                      |                                   | Pb-Free assembly (see Fig. 1) |
| Pre Heat  | -Temperature Min ( $T_{s(min)}$ ) | +150°C                        |
|   | -Temperature Max ( $T_{s(max)}$ ) | +200°C                        |
|   | -Time (Min to Max) ( $t_s$ )      | 60-180 secs.                  |
| Average ramp up rate (LiquidusTemp ( $T_L$ ) to peak) |                                   | 3°C/sec. Max.                 |
| $T_{s(max)}$ to $T_L$ - Ramp-up Rate                  |                                   | 3°C/sec. Max.                 |
| Reflow  | -Temperature ( $T_L$ ) (Liquidus) | +217°C                        |
|   | -Temperature ( $t_L$ )            | 60-150 secs.                  |
| Peak Temp ( $T_p$ )                                   |                                   | +260(+0/-5)°C                 |
| Time within 5°C of actual Peak Temp ( $t_p$ )         |                                   | 30 secs. Max.                 |
| Ramp-down Rate  |                                   | 6°C/sec. Max.                 |
| Time 25°C to Peak Temp ( $T_p$ )                      |                                   | 8 min. Max.                   |
| Do not exceed   |                                   | +260°C                        |

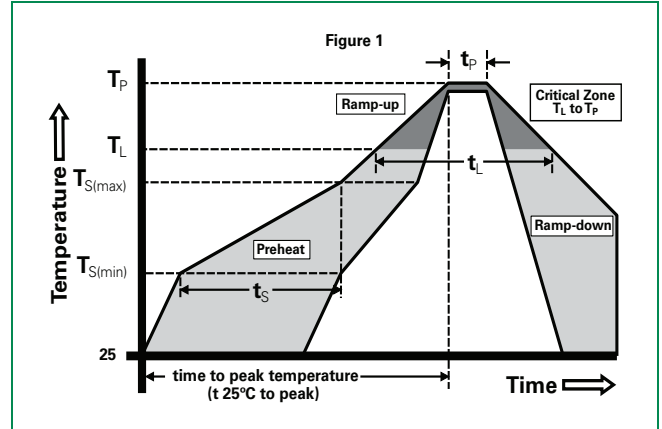

**Physical Specifications**

|                        |   |
|------------------------|---|
| <b>Lead Material</b>   | Copper Alloy  |
| <b>Terminal Finish</b> | 100% Matte-Tin Plated   |
| <b>Body Material</b>   | UL recognized epoxy meeting flammability classification 94V-0 |

**Environmental Specifications**

|   |  |
|---|--|
| <b>High Temp Voltage Blocking</b>       | 80% Rated $V_{DRM}$ ( $V_{AC Peak}$ ) +125°C or +150°C, 504 or 1008 hrs. MIL-STD-750 (Method 1040) JEDEC, JESD22-A-101 |
| <b>Temp Cycling</b>                     | -65°C to +150°C, 15 min. dwell, 10 up to 100 cycles. MIL-STD-750 (Method 1051) EIA/JEDEC, JESD22-A104                  |
| <b>Biased Temp &amp; Humidity</b>       | 52 $V_{DC}$ (+85°C) 85%RH, 504 up to 1008 hrs. EIA/JEDEC, JESD22-A-101   |
| <b>High Temp Storage</b>                | +150°C 1008 hrs. MIL-STD-750 (Method 1031) JEDEC, JESD22-A-101   |
| <b>Low Temp Storage</b>                 | -65°C, 1008 hrs.   |
| <b>Thermal Shock</b>                    | 0°C to +100°C, 5 min. dwell, 10 sec. transfer, 10 cycles. MIL-STD-750 (Method 1056) JEDEC, JESD22-A-106                |
| <b>Autoclave (Pressure Cooker Test)</b> | +121°C, 100%RH, 2atm, 24 up to 168 hrs. EIA/JEDEC, JESD22-A-102  |
| <b>Resistance to Solder Heat</b>        | +260°C, 30 secs. MIL-STD-750 (Method 2031)   |
| <b>Moisture Sensitivity Level</b>       | 85%RH, +85°C, 168 hrs., 3 reflow cycles (+260°C Peak). JEDEC-J-STD-020, Level 1  |

**Part Numbering**

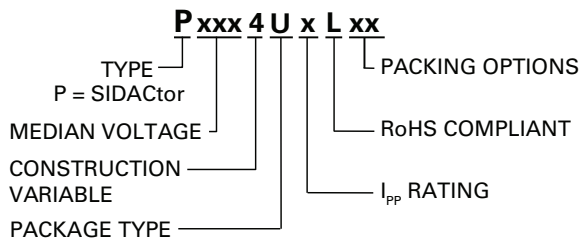

**Part Marking**

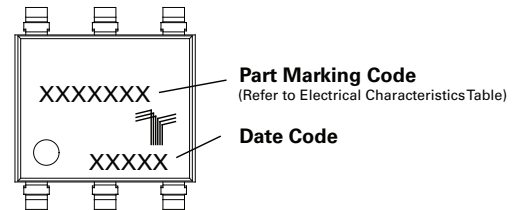

**Dimensions — MS-013**

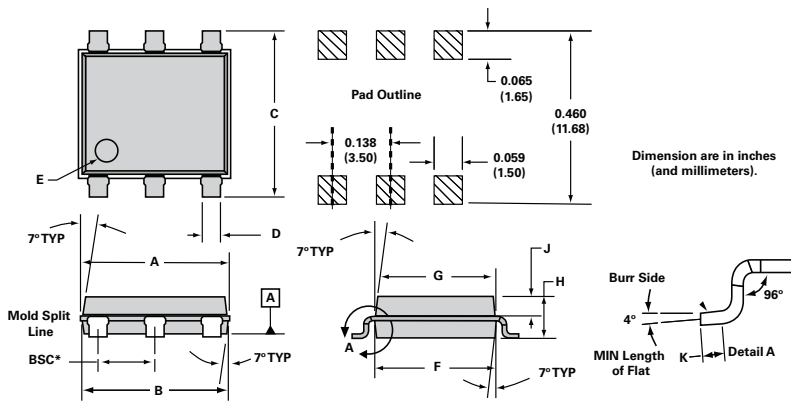

| Dimensions  | Inches |       | Millimeters |       |
|-------------|--------|-------|-------------|-------|
|             | Min    | Max   | Min         | Max   |
| <b>A</b>    | 0.360  | 0.364 | 9.14        | 9.25  |
| <b>B</b>    | 0.352  | 0.356 | 8.94        | 9.04  |
| <b>C</b>    | 0.400  | 0.412 | 10.16       | 10.46 |
| <b>D</b>    | 0.043  | 0.045 | 1.09        | 1.13  |
| <b>E</b>    | 0.047  | 0.055 | 1.19        | 1.40  |
| <b>F</b>    | 0.293  | 0.297 | 7.44        | 7.54  |
| <b>G</b>    | 0.289  | 0.293 | 7.34        | 7.44  |
| <b>H</b>    | 0.089  | 0.093 | 2.26        | 2.36  |
| <b>J</b>    | 0.041  | 0.049 | 1.04        | 1.24  |
| <b>K</b>    | 0.020  | —     | 0.51        | —     |
| <b>BSC*</b> | 0.133  | 0.143 | 3.38        | 3.63  |

\* BSC = Basic Spacing between Centers

**Packing Options**

| Package Type | Description                              | Quantity             | Added Suffix | Industry Standard |
|--------------|--|----------------------|--------------|-------------------|
| U            | Modified MS-013 6-pin Tape and Reel Pack | 1500                 | RP           | EIA-481-D         |
|              | Modified MS-013 6-pin Tube Pack          | 500<br>(50 per tube) | TP           | N/A               |

**Tape and Reel Specification — MS-013**

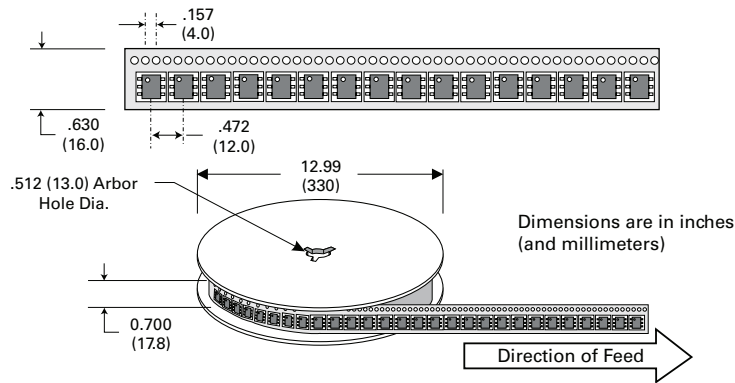

**Tube Pack Specification — MS-013**

