

**RoHS MC Multiport Series - MS-013**

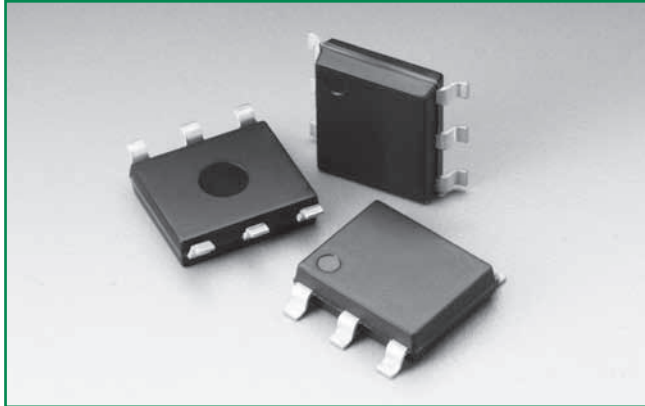

**Agency Approvals**

Agency	Agency File Number
	E133083

**Pinout Designation**

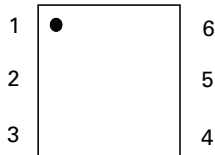

**Schematic Symbol**

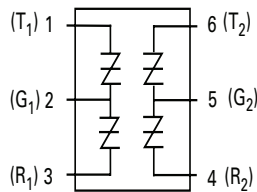

**Description**

MC Multiport Series MS-013 are low capacitance SIDACTor® devices designed to protect broadband equipment from damaging overvoltage transients.

The series provides a dual port surface mount solution that enables equipment to comply with various global regulatory standards while limiting the impact to broadband signals.

**Features and Benefits**

- Low voltage overshoot
- Low on-state voltage
- Does not degrade with use
- Fails short circuit when surged in excess of ratings
- Two-pair protection
- 40% lower capacitance than our Baseband Protectors, for applications that demand greater signal integrity
- Replaces four discrete devices

**Applicable Global Standards**

- TIA-968-A
- TIA-968-B
- ITU K.20/21 Enhanced Level
- ITU K.20/21 Basic Level
- GR 1089 Inter-building
- GR 1089 Intra-building
- IEC 61000-4-5
- YD/T 1082
- YD/T 993
- YD/T 950

**Electrical Characteristics**

Part Number	Marking	$V_{DRM}$ @ $I_{DRM}=5\mu A$	$V_S$ @ 100V/ $\mu s$	$V_{DRM}$ @ $I_{DRM}=5\mu A$	$V_S$ @ 100V/ $\mu s$	$I_H$	$I_S$	$I_T$	$V_T$ @ $I_T=2.2$ Amps	Capacitance
		V	V	V	V	mA min	mA max	A max	V max	
		Pins 1-2, 3-2, 4-5, 6-5		Pins 1-3, 4-6						
P0084UCMCLxx	P0084UCMC	6	25	12	50	50	800	2.2	8	See Capacitance Values Table
P0304UCMCLxx	P0304UCMC	25	40	50	80	50	800	2.2	8	
P0644UCMCLxx	P0644UCMC	58	77	116	154	150	800	2.2	8	
P0724UCMCLxx	P0724UCMC	65	88	130	176	150	800	2.2	8	
P0904UCMCLxx	P0904UCMC	75	98	150	196	150	800	2.2	8	
P1104UCMCLxx	P1104UCMC	90	130	180	260	150	800	2.2	8	
P1304UCMCLxx	P1304UCMC	120	160	240	320	150	800	2.2	8	

Notes:  
 - Absolute maximum ratings measured at  $T_A = 25^\circ C$  (unless otherwise noted).  
 - Devices are bi-directional (unless otherwise noted).  
 - **XX** Part Number Suffix: **TP** (Tube Pack) or **RP** (Reel Pack).

Table continues on next page.

**Electrical Characteristics** (continued)

Part Number	Marking	$V_{DRM}$ @ $I_{DRM}=5\mu A$	$V_S$ @ 100V/ $\mu s$	$V_{DRM}$ @ $I_{DRM}=5\mu A$	$V_S$ @ 100V/ $\mu s$	$I_H$	$I_S$	$I_T$	$V_T$ @ $I_T=2.2$ Amps	Capacitance
		V	V	V	V	mA min	mA max	A max	V max	
		Pins 1-2, 3-2, 4-5, 6-5		Pins 1-3, 4-6						
P1504UCMCLxx	P1504UCMC	140	180	280	360	150	800	2.2	8	See Capacitance Values Table
P1804UCMCLxx	P1804UCMC	170	220	340	440	150	800	2.2	8	
P2304UCMCLxx	P2304UCMC	190	260	380	520	150	800	2.2	8	
P2604UCMCLxx	P2604UCMC	220	300	440	600	150	800	2.2	8	
P3104UCMCLxx	P3104UCMC	275	350	550	700	150	800	2.2	8	
P3504UCMCLxx	P3504UCMC	320	400	600	800	150	800	2.2	8	

**Notes:**

- Absolute maximum ratings measured at  $T_A = 25^\circ C$  (unless otherwise noted).
- Devices are bi-directional (unless otherwise noted).
- **XX** Part Number Suffix: **'TP'** (Tube Pack) or **'RP'** (Reel Pack).

**Capacitance Values**

Part Number	pF Pin 1-2 / 3-2 (4-5 / 6-5) Tip-Ground, Ring-Ground		pF Pin 1-3 (4-6) Tip-Ring	
	MIN	MAX	MIN	MAX
	P0084UCMCLxx	35	75	20
P0304UCMCLxx	25	45	10	25
P0644UCMCLxx	55	85	30	50
P0724UCMCLxx	50	75	25	45
P0904UCMCLxx	45	70	25	40
P1104UCMCLxx	45	70	25	40
P1304UCMCLxx	40	60	20	35
P1504UCMCLxx	35	55	20	35
P1804UCMCLxx	35	50	15	30
P2304UCMCLxx	30	50	15	30
P2604UCMCLxx	30	45	15	30
P3104UCMCLxx	30	45	15	25
P3504UCMCLxx	25	40	15	25

Note: Off-state capacitance ( $C_o$ ) is measured at 1 MHz with a 2 V bias.

**Surge Ratings**

Series	$I_{PP}$									$I_{TSM}$ 50/60 Hz	di/dt
	0.2x310 <sup>1</sup> 0.5x700 <sup>2</sup>	2x10 <sup>1</sup> 2x10 <sup>2</sup>	8x20 <sup>1</sup> 1.2x50 <sup>2</sup>	10x160 <sup>1</sup> 10x160 <sup>2</sup>	10x560 <sup>1</sup> 10x560 <sup>2</sup>	5x320 <sup>1</sup> 9x720 <sup>2</sup>	10x360 <sup>1</sup> 10x360 <sup>2</sup>	10x1000 <sup>1</sup> 10x1000 <sup>2</sup>	5x310 <sup>1</sup> 10x700 <sup>2</sup>		
	A min	A min	A min	A min	A min	A min	A min	A min	A min		
C	50	500	400	200	150	200	175	100	200	30	500

**Notes:**

- 1 Current waveform in  $\mu s$
- 2 Voltage waveform in  $\mu s$

- Peak pulse current rating ( $I_{pp}$ ) is repetitive and guaranteed for the life of the product.
- $I_{pp}$  ratings applicable over temperature range of  $-40^\circ C$  to  $+85^\circ C$
- The device must initially be in thermal equilibrium with  $-40^\circ C \leq T_j \leq +150^\circ C$

**Thermal Considerations**

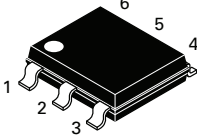
Package	Symbol	Parameter	Value	Unit
Modified MS-013 	$T_J$	Operating Junction Temperature Range	-40 to +150	°C
	$T_S$	Storage Temperature Range	-65 to +150	°C
	$R_{\theta JA}$	Thermal Resistance: Junction to Ambient	60	°C/W

**V-I Characteristics**

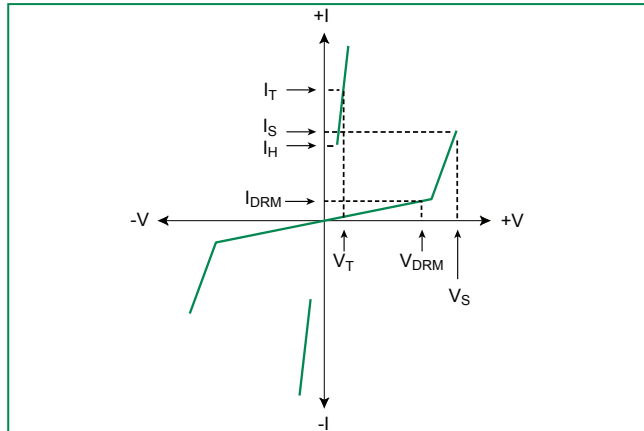

**$t_r \times t_d$  Pulse Waveform**

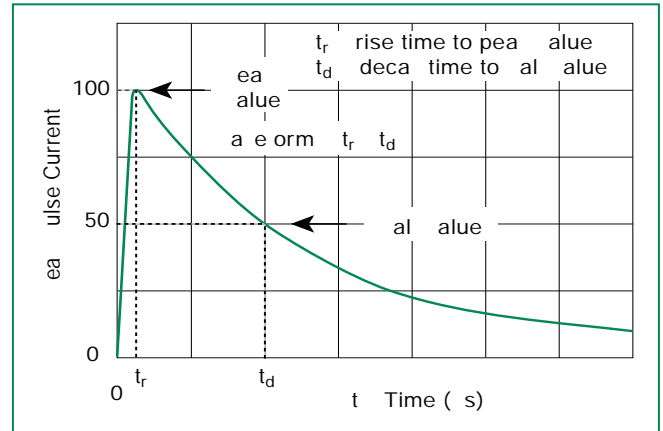

**Normalized  $V_S$  Change vs. Junction Temperature**

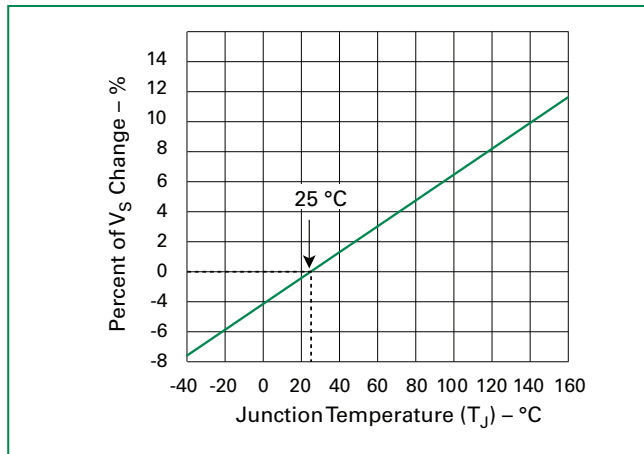

**Normalized DC Holding Current vs. Case Temperature**

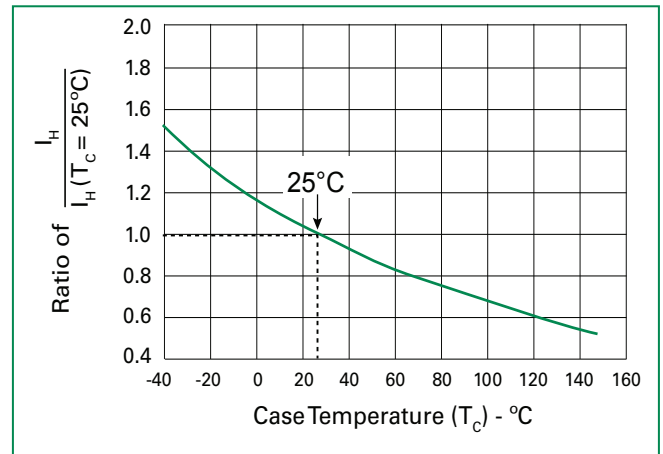

**Soldering Parameters**

Reflow Condition		Pb-Free assembly (see Fig. 1)
Pre Heat	- Temperature Min ( $T_{s(min)}$ )	+150°C
	- Temperature Max ( $T_{s(max)}$ )	+200°C
	- Time (Min to Max) ( $t_s$ )	60-180 secs.
Average ramp up rate (LiquidusTemp ( $T_L$ ) to peak)		3°C/sec. Max.
$T_{s(max)}$ to $T_L$ - Ramp-up Rate		3°C/sec. Max.
Reflow	- Temperature ( $T_L$ ) (Liquidus)	+217°C
	- Temperature ( $t_L$ )	60-150 secs.
Peak Temp ( $T_p$ )		+260(+0/-5)°C
Time within 5°C of actual Peak Temp ( $t_p$ )		30 secs. Max.
Ramp-down Rate		6°C/sec. Max.
Time 25°C to Peak Temp ( $T_p$ )		8 min. Max.
Do not exceed		+260°C

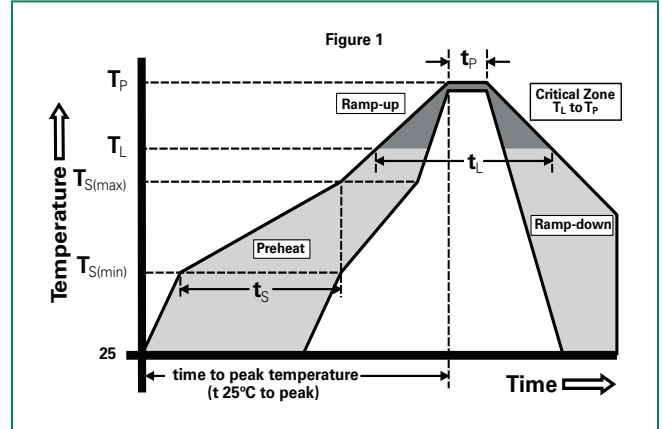

**Physical Specifications**

<b>Lead Material</b>	Copper Alloy
<b>Terminal Finish</b>	100% Matte-Tin Plated
<b>Body Material</b>	UL recognized epoxy meeting flammability classification 94V-0

**Part Numbering**

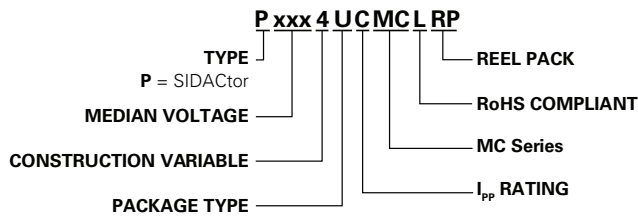

**Environmental Specifications**

<b>High Temp Voltage Blocking</b>	80% Rated $V_{DRM}$ ( $V_{AC}$ Peak) +125°C or +150°C, 504 or 1008 hrs. MIL-STD-750 (Method 1040) JEDEC, JESD22-A-101
<b>Temp Cycling</b>	-65°C to +150°C, 15 min. dwell, 10 up to 100 cycles. MIL-STD-750 (Method 1051) EIA/JEDEC, JESD22-A-104
<b>Biased Temp &amp; Humidity</b>	52 $V_{DC}$ (+85°C) 85%RH, 504 up to 1008 hrs. EIA/JEDEC, JESD22-A-101
<b>High Temp Storage</b>	+150°C 1008 hrs. MIL-STD-750 (Method 1031) JEDEC, JESD22-A-101
<b>Low Temp Storage</b>	-65°C, 1008 hrs.
<b>Thermal Shock</b>	0°C to +100°C, 5 min. dwell, 10 sec. transfer, 10 cycles. MIL-STD-750 (Method 1056) JEDEC, JESD22-A-106
<b>Autoclave (Pressure Cooker Test)</b>	+121°C, 100%RH, 2atm, 24 up to 168 hrs. EIA/JEDEC, JESD22-A-102
<b>Resistance to Solder Heat</b>	+260°C, 30 secs. MIL-STD-750 (Method 2031)
<b>Moisture Sensitivity Level</b>	85%RH, +85°C, 168 hrs., 3 reflow cycles (+260°C Peak). JEDEC-J-STD-020, Level 1

**Part Marking**

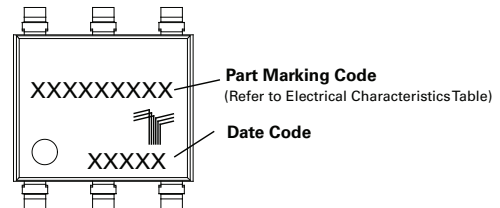

**Dimensions — MS-013**

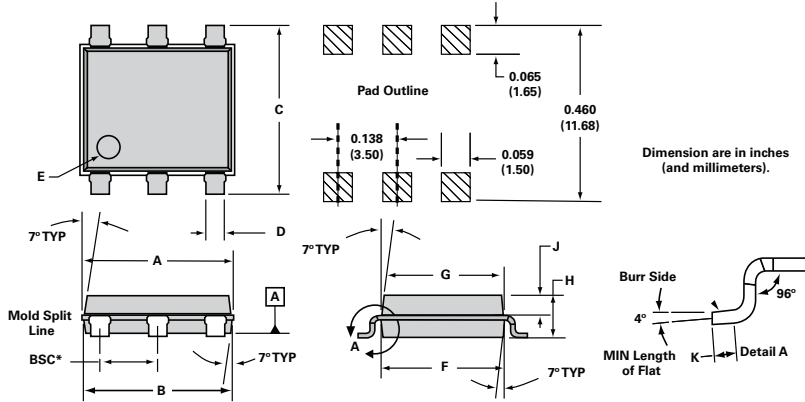

Dimensions	Inches		Millimeters	
	Min	Max	Min	Max
<b>A</b>	0.360	0.364	9.14	9.25
<b>B</b>	0.352	0.356	8.94	9.04
<b>C</b>	0.400	0.412	10.16	10.46
<b>D</b>	0.043	0.045	1.09	1.13
<b>E</b>	0.047	0.055	1.19	1.40
<b>F</b>	0.293	0.297	7.44	7.54
<b>G</b>	0.289	0.293	7.34	7.44
<b>H</b>	0.089	0.093	2.26	2.36
<b>J</b>	0.041	0.049	1.04	1.24
<b>K</b>	0.020		0.51	
<b>BSC*</b>	0.133	0.143	3.38	3.63

\* BSC = Basic Spacing between Centers

**Packing Options**

Package Type	Description	Quantity	Added Suffix	Industry Standard
U	Modified MS-013 6-pin Tape and Reel Pack	1500	RP	EIA-481-D
	Modified MS-013 6-pin Tube Pack	500 (50 per tube)	TP	N/A

**Tape and Reel Specification — MS-013**

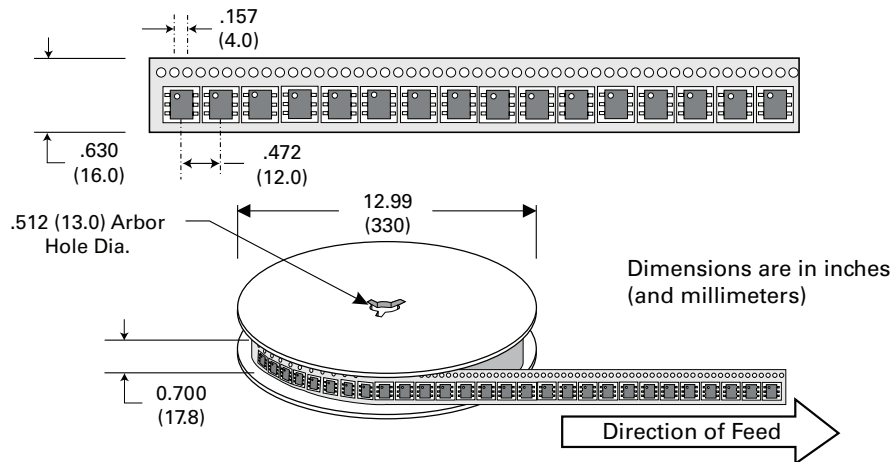

**Tube Pack Dimensions — MS-013**

