

YAMAHA

POWER AMPLIFIER

P3500

P2500

P1500

OWNER'S MANUAL
MANUEL D'UTILISATION
BEDIENUNGSANLEITUNG
MANUAL DE INSTRUCCIONES

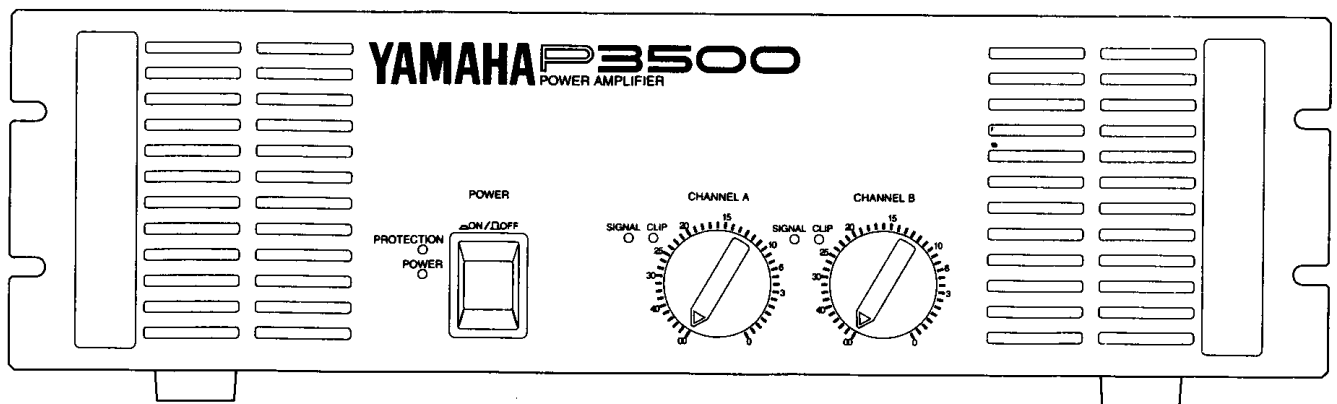

Introduction

Thank you for purchasing a Yamaha P3500/2500/1500 series power amplifier. This series of audio amplifiers combines high-power performance with reliability. While Yamaha's renown attention to circuitry detail ensures excellent sonic performance.

Input connections consist of balanced XLR-type jacks, balanced 1/4" phone jacks, and barrier strip. Output connections consist of 5-way binding posts and barrier strip.

Operating modes are: Stereo and Bridge. In Stereo mode, channels A and B operate independently, just like a typical stereo amplifier. In Bridge mode, however, channels A and B are bridged together and work as one mono amplifier, providing real high-power performance.

Front-panel LED indicators provide continuous amplifier status indication, with independent SIGNAL and CLIP indicators for each channel. A PROTECTION LED shows the status of the various protection systems, which include, soft-start power ON-OFF, output muting, DC protection, and heat sink overheat. Twin two-speed low-noise fans ensure that these amplifiers remain in control even under the most demanding conditions.

Note that this Owner's Manual covers the Yamaha P3500, P2500, and P1500 power amplifiers. The only difference between these amplifiers, however, is output power, their feature set is the same.

In order to take full advantage of your power amplifier, please read through this manual.

Contents

Introduction	2
Precautions	3
Operation	4
Caution for Speaker Connection	7
Troubleshooting	8
Specifications	9
Dimensions	11
Performance Graphs	11

Precautions

- 1. Avoid Excessive Heat, Humidity, Dust and Vibration**
Keep the unit away from locations where it is likely to be exposed to high temperatures or humidity — such as near radiators, stoves, etc. Also avoid locations which are subject to excessive dust accumulation or vibration which could cause mechanical damage.
- 2. Avoid Physical Shocks**
Strong physical shocks to the unit can cause damage. Handle it with care.
- 3. Do Not Open The Case Or Attempt Repairs Or Modifications Yourself**
This product contains no user-serviceable parts. Refer all maintenance to qualified Yamaha service personnel. Opening the case and/or tampering with the internal circuitry will void the warranty.
- 4. Make Sure Power Is Off Before Making Or Removing Connections**
Always turn the power OFF prior to connecting or disconnecting cables. This is important to prevent damage to the unit itself as well as other connected equipment.
- 5. Handle Cables Carefully**
Always plug and unplug cables — including the AC cord — by gripping the connector, not the cord.
- 6. Clean With a Soft Dry Cloth**
Never use solvents such as benzine or thinner to clean the unit. Wipe clean with a soft, dry cloth.
- 7. Always Use the Correct Power Supply**
Make sure that the power supply voltage specified on the rear panel matches your local AC mains supply. Also make sure that the AC mains supply can deliver more than enough current to handle all equipment used in your system.

Dette apparat overholder det gældende EF-direktiv vedtrørende radiostøj.

Cet appareil est conforme aux prescriptions de la directive communautaire 87/308/CEE.

Diese Geräte entsprechen der EG-Richtlinie 82/499/EWG und/oder 87/308/EWG.

This product complies with the radio frequency interference requirements of the Council Directive 82/499/EEC and/or 87/308/EEC.

Questo apparecchio è conforme al D.M.13 aprile 1989 (Direttiva CEE/87/308) sulla soppressione dei radiodisturbi.

Este producto está de acuerdo con los requisitos sobre interferencias de radio frecuencia fijados por el Consejo Directivo 87/308/CEE.

YAMAHA CORPORATION

IMPORTANT NOTICE FOR THE UNITED KINGDOM

Connecting the Plug and Cord

IMPORTANT: The wires in this mains lead are coloured in accordance with the following code:

BLUE	: NEUTRAL
BROWN	: LIVE

As the colours of the wires in the mains lead of this apparatus may not correspond with the coloured markings identifying the terminals in your plug, proceed as follows:

The wire which is coloured BLUE must be connected to the terminal which is marked with the letter N or coloured BLACK.

The wire which is coloured BROWN must be connected to the terminal which is marked with the letter L or coloured RED.

Making sure that neither core is connected to the earth terminal of the three pin plug.

* This applies only to products distributed by YAMAHA KEMBLE MUSIC (U.K.) LTD.

Operation

■ Front Panel

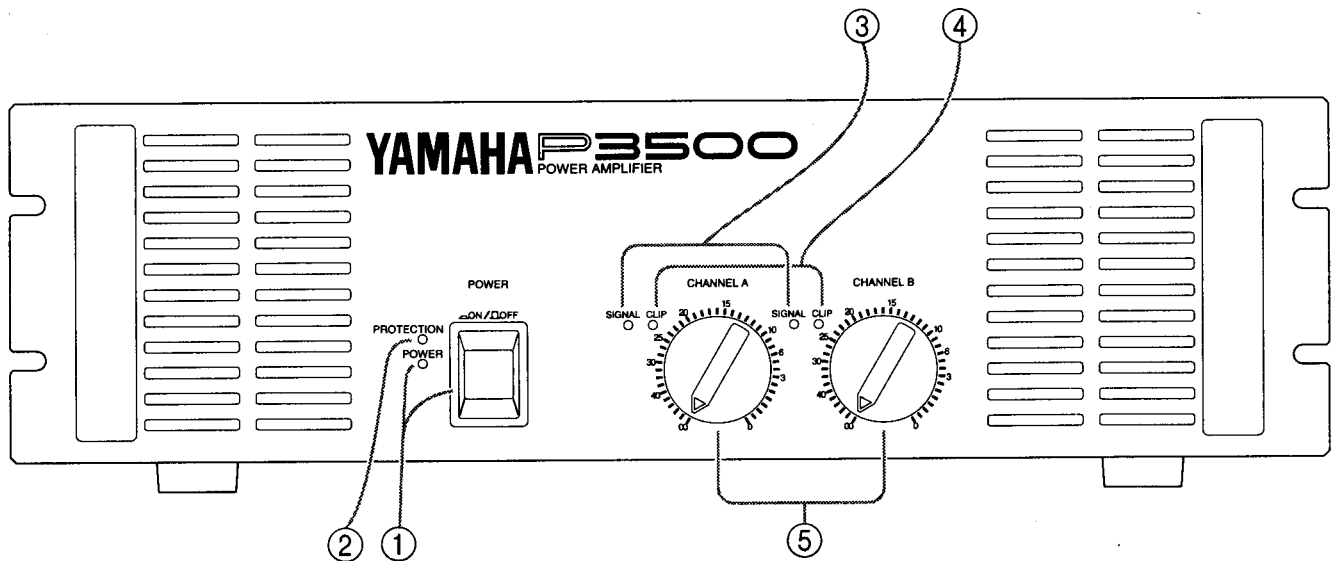

① **POWER switch and indicator**

This is the main POWER switch. Press to power ON the amplifier. Press again to power OFF. The POWER indicator lights up when the amplifier is powered ON.

② **PROTECTION indicator**

This red LED indicator lights up for approximately six seconds when the amplifier is powered ON, indicating that the soft-start protection system is working. No sound is output during soft-start up. If one of the protection systems is activated during normal use, this indicator lights up and no sound is output. The speaker system is actually disconnected from the amplifier outputs when this indicator lights up. The protection systems are activated when overheating occurs or a DC voltage is present at the amplifier outputs. If the problem is corrected, the protection systems deactivate automatically, this indicator goes out, and normal amplifier operation is resumed.

③ **SIGNAL indicators**

These green LED indicators light up when the respective channel's output signal exceeds 2V rms. This is equivalent to 1/2 watt into 8 Ω , 1W into 4 Ω . This indicates that an input signal is present.

④ **CLIP indicators**

These red LED indicators light up when the respective channel's output signal distortion exceeds 1% (i.e. clipping). Output signal clipping is usually due to excessive input signal levels.

⑤ **Input attenuators**

These are 41-step detented input signal attenuators. Attenuation range is from 0dB to ∞ (infinity).

■ Rear Panel

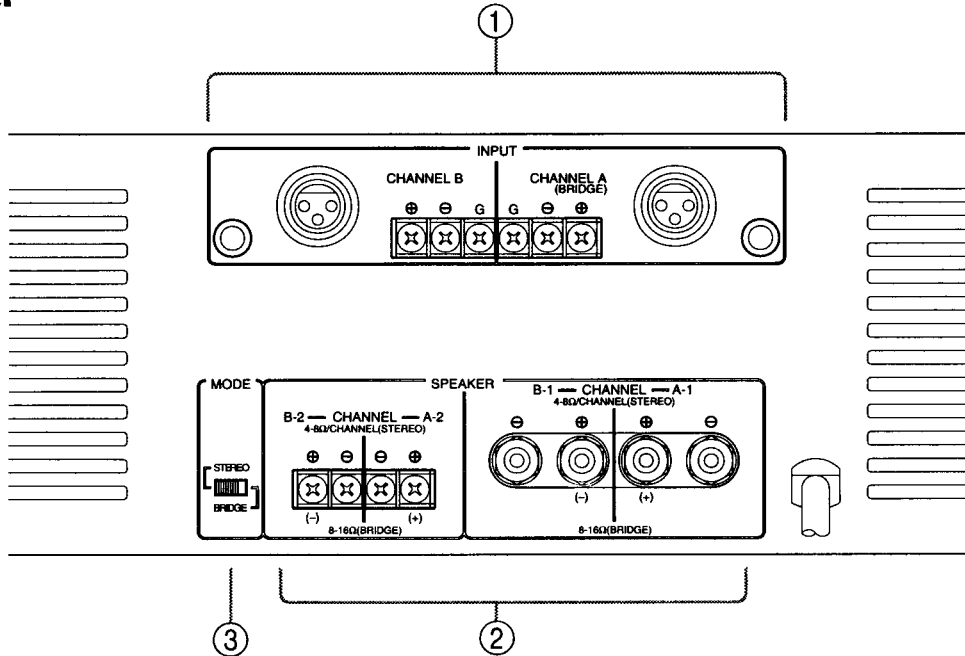

① INPUT terminals (CHANNEL A, B)

Three types of balanced terminals for channels A and B are provided.

Channel A input terminal is used in Bridge mode.

- **XLR-type connector**

They are wired pin 1–ground, pin 2–hot (+), and pin 3 cold (–).

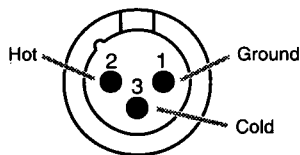

- **Phone jack**

They are wired tip–hot (+), ring–cold (–), and sleeve–ground.

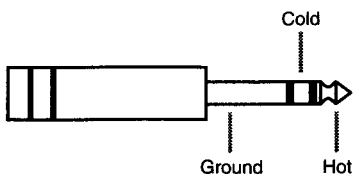

- **Barrier strip**

Ground, hot (+), and cold (–).

② SPEAKER terminals

Two types of output terminals are provided.

For polarity in each mode, refer to the following diagram.

- **STEREO mode**

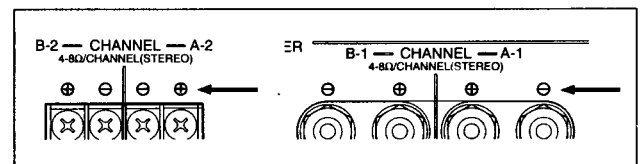

- **BRIDGE mode**

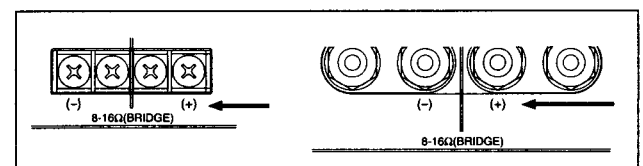

The minimum impedance for the connected speaker system is specified in “Speaker Impedance” on page 6.

③ STEREO-BRIDGE switch

This slide switch is used to set the amplifier operating mode: STEREO or BRIDGE.

■ Stereo mode and Bridge mode

STEREO mode

In this mode, channels A and B operate independently (typical stereo amplifier). Channel A input signal feeds channel A power amp, and channel B input signal feeds channel B power amp. In this mode, the minimum speaker impedance per channel is 4 Ω.

■ SPEAKER IMPEDANCE

P3500/P2500/P1500 series amplifier has two operating modes: Stereo and Bridge, and allows you to connect multiple speaker systems in parallel. Therefore, the minimum speaker impedance varies depending on the combination of these speakers. Be sure that the speaker impedance falls below the specified impedance.

STEREO mode connections

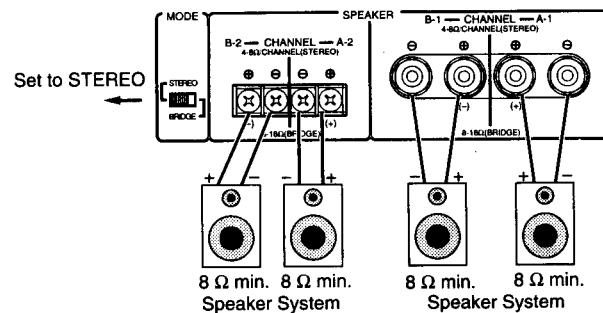
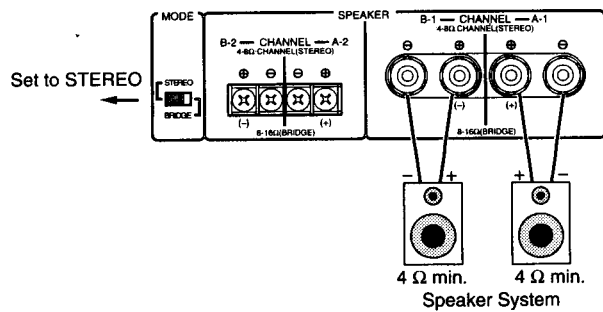
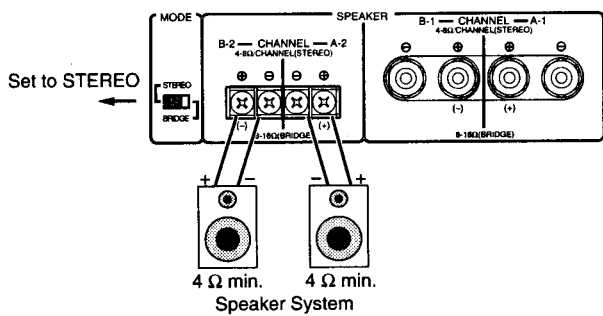

BRIDGE mode

In this mode, channels A and B are bridged together and work as one mono amplifier. In this mode, the minimum speaker impedance is 8 Ω.

BRIDGE mode connections

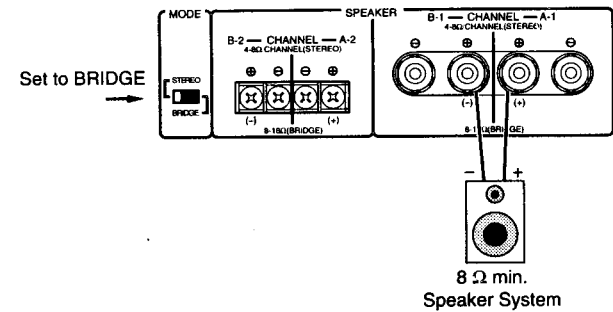
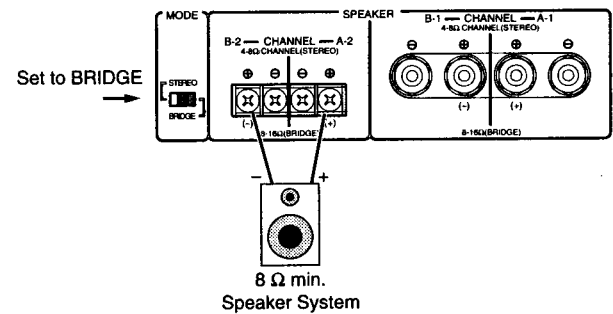

Caution for Speaker Connection

1. Turn off the POWER switch.
2. Remove the cover attachment screw(s) and remove the protective cover from the speaker terminals.

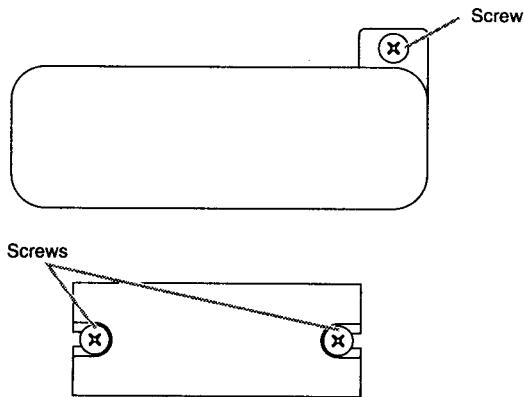

3. After removing approx. 10 mm of insulation from the ends of the speaker cables, pass the bare ends of the speaker wires through the holes in the corresponding speaker terminals and tighten the terminals to securely clamp the wires. Refer to page 4 for speaker polarity.

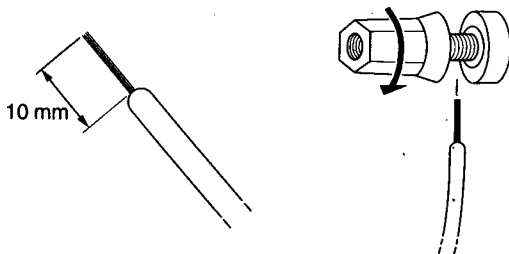

At this time make sure that the bare ends of the speaker cables do not extend from the terminals in such a way that they touch the chassis.

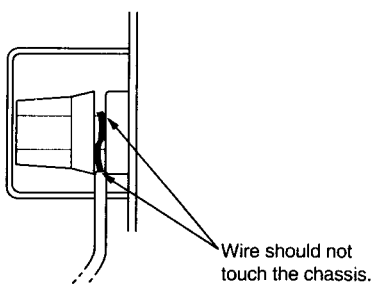

4. Reattach the protective cover over the speaker terminals.

• Speaker fuse

The output capacity of your amplifier is very high: 350W+350W (8 Ω) in stereo and 1000W (8 Ω) in monaural on the P3500; 250W+250W (8 Ω) in stereo and 700W (8 Ω) in monaural on the P2500; 150W+150W (8 Ω) in stereo and 420W (8 Ω) in monaural on the P1500. Be sure to use a speaker system that has sufficient input capacity.

If the input capacity of your speaker system is lower than the rated output of the power amplifier, you can protect your speakers by connecting a fuse serially between the speaker and amplifier as shown below.

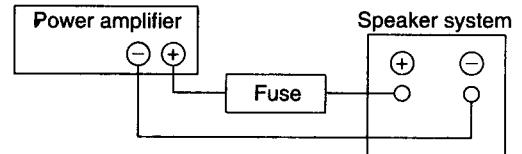

Use the following formula to determine the fuse capacity according to the speaker's input capacity.

$$P_0 = I^2 R \rightarrow I = \sqrt{\frac{P_0}{R}}$$

P_0 [W] : Speaker's continuous input capacity (noise or RMS)

R [Ω] : Speaker's nominal impedance

I [A] : Required fuse capacity

ex.) Speaker's continuous input capacity : 100W
Speaker's impedance : 8 Ω

$$I = \sqrt{\frac{100}{8}} = 3.5$$

In this example, the required fuse capacity is calculated as 3.5 [A].

• Speaker cable

If you use a long speaker cable, use as thick a cable as possible to prevent deterioration of the damping factor or power loss inside the cable. Even the thickest cable can be used for the speaker terminal of this unit.

■ Portable Rack Mounting

The amplifier intakes cool air through the front panel and exhausts warm air out the rear panel. When mounting amplifiers in a portable rack, make sure the rear panel is completely open for ventilation.

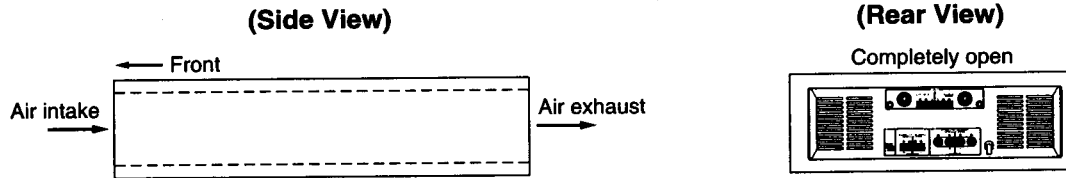

■ Positioning the Housed Amplifier

Place the case so that the ventilation airflow paths are not blocked.

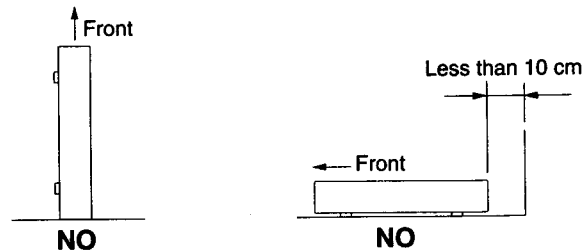

Troubleshooting

The following table lists the main causes of abnormal operation and the corrective measures required, as well as the protective circuit operation in each case.

Indicator	Probable Cause	Remedy	Protection Circuit
CLIP indicator lights.	There is a short at a speaker terminal, amplifier terminal, or wire.	Locate and correct the cause of the short.	The PC limiter circuit operates to protect the power transistors.
	The amplifier load is excessive.	Use a speaker system with an impedance of at least 4 Ω (stereo) or 8 Ω (bridge).	Same as above.
PROTECTION indicator lights.	The heat sink temperature has exceeded 100°C	Check the amplifier ventilation conditions and take appropriate measures to improve airflow around the amplifier.	The thermal protection circuit operates to protect the power transistors.
	A DC voltage of +/-2V or greater was generated in the power amplifier's output circuit.	Consult your dealer or nearest Yamaha service center.	The relay operates to protect the speaker system.

Specifications

■ General Specifications P3500, P2500, P1500

		P3500	P2500	P1500
POWER OUTPUT LEVEL f=20 Hz~20 kHz, THD+N ≤ 0.1%				
	STEREO RL=8 Ω	350 W + 350 W	250 W + 250 W	150 W + 150 W
	BRIDGE RL=4 Ω	500 W + 500 W	350 W + 350 W	210 W + 210 W
	BRIDGE RL=8 Ω	1000 W	700 W	420 W
f=1 kHz, THD+N ≤ 0.1% (Typical)				
	STEREO RL=8 Ω	395 W + 395 W	285 W + 285 W	170 W + 170 W
	RL=4 Ω	620 W + 620 W	430 W + 430 W	240 W + 240 W
	RL=2 Ω*	1000 W + 1000 W	450 W + 450 W	280 W + 280 W
FREQUENCY RESPONSE RL=8 Ω, Po=1 W		0 dB+0.5, -1.5 dB; f=10 Hz~50 kHz		
POWER BANDWIDTH HALF POWER, THD+N ≤ 0.1% STEREO RL=8 Ω		10 Hz~40 kHz		
TOTAL HARMONIC DISTORTION (THD+N) f=20 Hz~20 kHz, HALF POWER				
	STEREO RL=8 Ω		≤ 0.05%	
	BRIDGE RL=4 Ω		≤ 0.07%	
	BRIDGE RL=8 Ω		≤ 0.07%	
INTERMODULATION DISTORTION (IMD) f=60 Hz: 7 kHz, 4:1, HALF POWER				
	STEREO RL=8 Ω		≤ 0.05%	
	BRIDGE RL=4 Ω		≤ 0.07%	
	BRIDGE RL=8 Ω		≤ 0.07%	
CHANNEL SEPARATION HALF POWER, RL=8 Ω, f=1kHz ATT. max. Input 600 Ω shunt		≥ 80 dB		
RESIDUAL NOISE DIN AUDIO		≤ -72 dB; ATT min.		
SIGNAL-TO-NOISE RATIO DIN AUDIO, Input 600 Ω shunt		≥ 100 dB		
DAMPING FACTOR RL=8 Ω, f=1 kHz		≥ 100	≥ 100	≥ 70
SLEW RATE 8 Ω FULL SWING				
	STEREO		±40V/μs	
	BRIDGE		±40V/μs	
SENSITIVITY (ATT max.) Rated Power into 8 Ω 1kHz		+4 dBm		
VOLTAGE GAIN (ATT max.) 8 Ω 1kHz		33 dB	31 dB	29 dB
INPUT IMPEDANCE (ATT max.)		≥ 15 kΩ (Balance/Unbalance)		
INDICATORS		POWER (STAND-BY) (Red) PROTECTION (MUTE) (Red) CLIP × 2 (Red) SIGNAL × 2 (Green)		
PROTECTION		Power SW ON/OFF muting Heatsink temp ≥ 100°C (212°F)		
PC LIMITER		RL < 2 Ω		
FAN CIRCUIT		— 50°C (122°F) — 60°C (140°F) — Low-speed — variable — Hi-speed		

CONTROLS	(FRONT) POWER SW; Push on/Push off Attenuator; 41-position dB calibrated (REAR) Mode SW; STEREO/BRIDGE = BTL
POWER REQUIREMENT	UL & Canadian Models: 120 V, 60 Hz General Model: 230 V, 50 Hz British Model: 240 V, 50 Hz
POWER CONSUMPTION	1000 W/1200 VA 750 W/1000 VA 500 W/600 VA
DIMENSIONS W × H × D	480 × 143.1 × 438.1 (mm) Panel height: 132 mm Depth behind front panel: 395 mm
WEIGHT	26 kg 24 kg 18 kg
CONNECTORS	INPUT XLR-3-31 type × 2 1/4" Phone (balance) × 2 Barrier strip × 2 OUTPUT 5-way binding posts × 2 Barrier strip × 2

0 dB = 0.775 Vrms, Half Power = 1/2 Power Output Level (Rated Power)

* Using reactive 2 Ω speakers at high power levels may cause overheating, excessive power consumption, and shutdowns. Please note that below 2 Ω the PC limiter will work. Before using 2 Ω speakers in a real application, test the system completely.

Specifications subject to change without notice.

■ Block Diagram

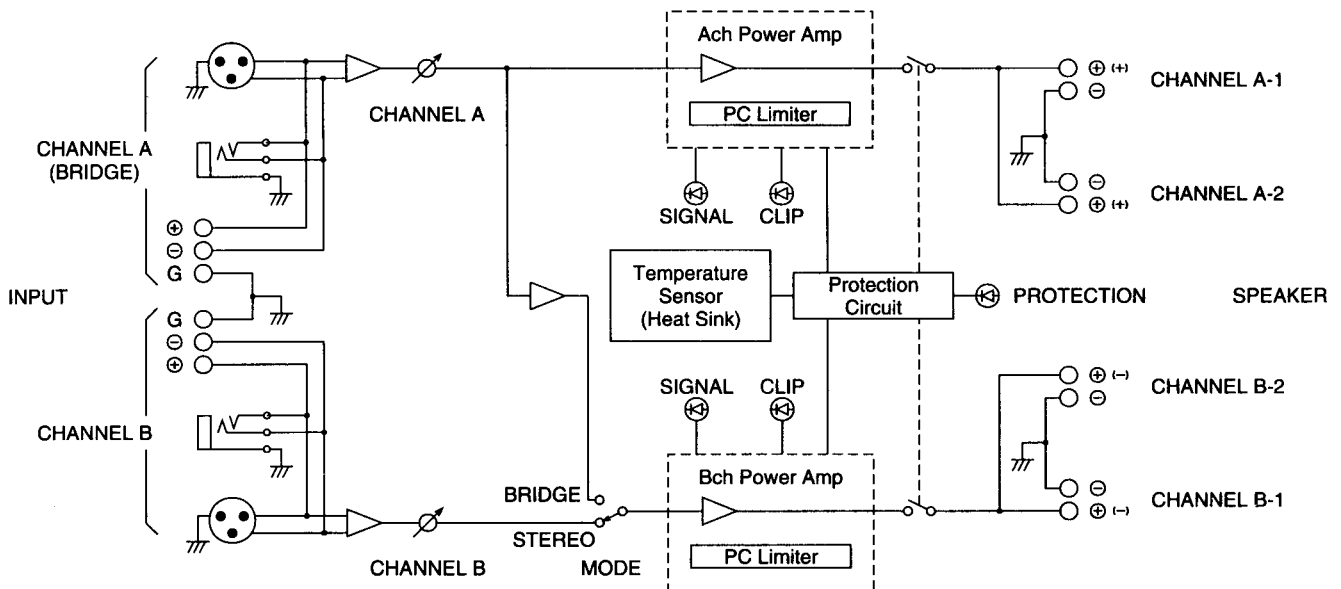

Dimensions

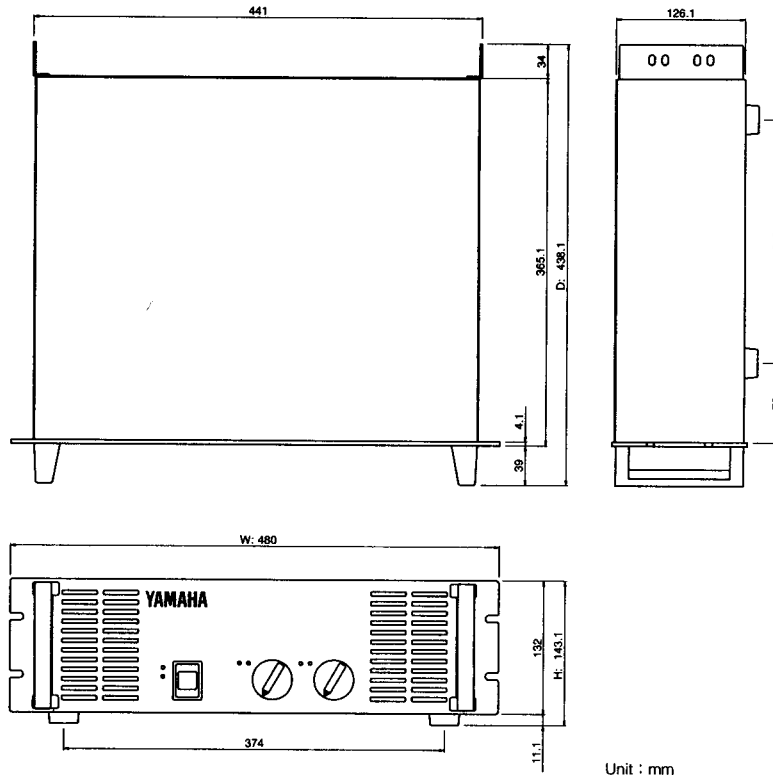

Performance Graphs

— P3500 —

POWER CONSUMPTION vs OUTPUT POWER
 MODE : STEREO
 Both Ch. Driven
 f = 1 kHz

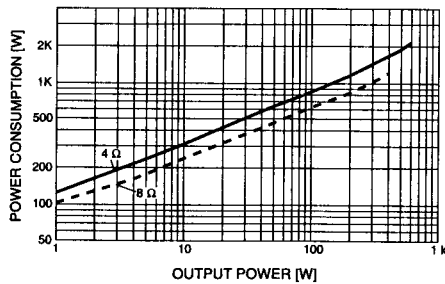

— P1500 —

POWER CONSUMPTION vs OUTPUT POWER
 MODE : STEREO
 Both Ch. Driven
 f = 1 kHz

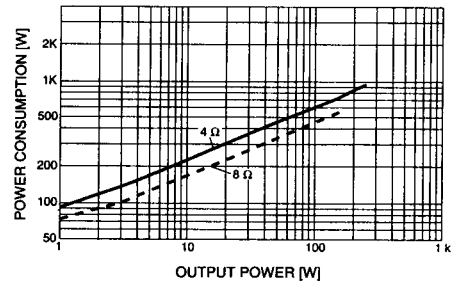

— P2500 —

POWER CONSUMPTION vs OUTPUT POWER
 MODE : STEREO
 Both Ch. Driven
 f = 1 kHz

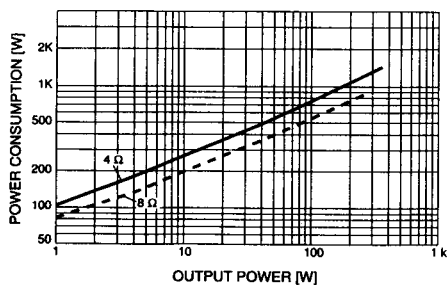

YAMAHA