

A 05-21-01

## Tantalum Electrolytic Capacitors Sintered Anode, Solid Semiconductor Electrolyte, +125°C

ETPW

Tantalum capacitors with sintered anode and solid semiconductor electrolyte, with flame retardant fluidized bed coating. The ETPW type is an ideal component for multipurpose application, in particular at high ambient temperatures. The capacitor complies with DIN 44 356/45 910 part 146.

Furthermore, this type is available in a radially taped version.

Colour: Green

Marking: Black stamping (in clear text)

### Dimensions

#### Standard version

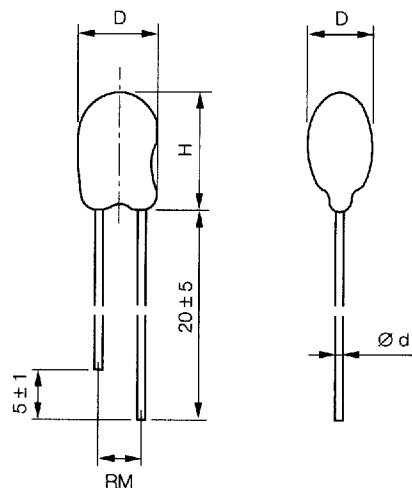

#### Special advantages of ETPW:

- Flame retardant encapsulation
- Practically without epoxy run down
- Very high temperature range
- Improved humidity class
- Low leakage current
- Very high CV product
- Low temperature dependence
- High operation reliability
- Low failure rate

Leads: tinned

#### S style

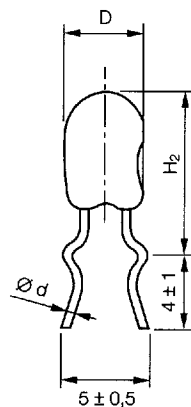

#### DS style

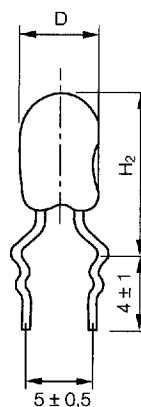

#### L style

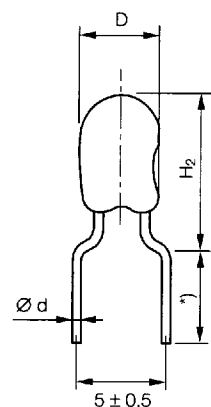

Capacitors must not correspond with the sketches, only the dimensions have to be kept.

<sup>1)</sup> only in taped version available, lead length see taping page 8

### Dimensions (mm)

Typ	D max.	H max.	Style S,DS,L H <sub>2</sub> max.	RM ± 0,5	Ø d ± 0,05
ETPW 1	4,5	7,5	10,5	2,5	0,5
ETPW 2	5	9,5	12,5	2,5	0,5
ETPW 3	6	10,5	13,5	2,5	0,5
ETPW 4	6,5	11,5	14,5	2,5	0,5
ETPW 5	9	14	17 <sup>1)</sup>	5	0,5
ETPW 6	9,5	17	20 <sup>1)</sup>	5	0,5

<sup>1)</sup> only "S" style

**ETPW****Technical data:****Application class:**

FKD according to DIN 40 040

**Climatic class:**

55/125/56 according to IEC

**Temperature range:**

-55°C up to +125°C, as of +85°C voltage derating

**Rated voltage:**

3V- up to 50V-

**Category voltage:**

2V- up to 33V-

**Peak voltage:**

1,3 times the rated voltage at +85°C

**Reverse voltage:**

(temporarily)

15% of rated voltage at +20°C

10% of rated voltage at +55°C

5% of rated voltage at +85°C

**Rated capacitance:**

0,1 µF up to 330 µF

**Capacitance tolerance:**

± 20%; close ± 10%

**Leakage current in µA:****(measured at +20°C after 5 minutes)**≤ 0,01 · C<sub>R</sub> · U<sub>R</sub> or 0,5 µA,

whichever is greater.

See table (restricted leakage current values upon request).

**Dissipation factor:****(at 120 Hz and +20°C)**

See table

**Impedance:****(measured at 100 kHz and +20°C)**

See table

**Voltage derating:**

See Diagram 1 General Information

**Leakage current behaviour and leakage current change at various operating voltages:**

See General Information

**Frequency and temperature behaviour of capacitance, dissipation factor, impedance, equivalent series resistance:**

See Diagrams 1 -14

**Permissible AC voltage stress:**

The highest permissible AC voltage for the respective frequency may be taken from Diagrams 15 to 19.

The values apply for +20°C. For higher temperatures, the values have to be multiplied with the following factors:

Temperature	Factor
+ 50°C	0,7
+ 85°C	0,5
+ 125°C	0,3

Intermediate values can be obtained by linear interpolation.

For further notes on AC voltage stress: See General Information

**Service life:**

&gt; 300 000 hours \*)

**Failure percentage:**

≤ 0,6% within 100 000 hours \*)

**Failure rate (λ):**≤ 0,6 · 10<sup>-7</sup>/h = ≤ 60 fit \*)\*) related to U<sub>R</sub> +40°C and a circuit resistance of ≥ 3Ω/V**Failure criteria:**

Complete failure: Short circuit or interruption

Change failure:

ΔC &gt; +5 -15%

Z &gt; 3 times initial limit value

I<sub>R</sub> > 5 times initial limit value +5 µA**Internal resistance of power source:**

See General Information

**Other technical specifications:****Permissible tensile stress of leads:**

10 N of constant stress for 30 sec. in lead direction.

**Permissible bending stress of leads:**

2 bendings under stress of 2,5 N

(A bending means: To curve the lead by 90° from normal position and back into normal position. All bendings have to be performed in one plane, and all succeeding bendings in opposite direction each).

## ETPW

### Features at high and low temperatures (limit values)

Test temperature	-55°C	+20°C	+85°C	+125°C
Permissible capacitance change $\Delta C/C$	-10 %	-	+ 12 %	+ 15 %
$\tan \delta$				
$\leq 1,5 \mu\text{F}$	0,04	0,04	0,04	0,06
$< 10 \mu\text{F}$	0,06	0,06	0,06	0,08
$< 100 \mu\text{F}$	0,08	0,08	0,08	0,08
$\geq 100 \mu\text{F}$	0,1	0,1	0,1	0,1
Leakage current $I_R$	-	$\leq 0,01 \cdot C_R \cdot U_R$ or $0,5 \mu\text{A}$ , whichever is greater	$\leq 0,1 \cdot C_R \cdot U_R$ or $10 \mu\text{A}$ , whichever is greater	$\leq 0,125 \cdot C_R \cdot U_R$ or $12,5 \mu\text{A}$ , whichever is greater <sup>1)</sup>

<sup>1)</sup> Measured at category voltage

### Marking example:

The positive pole is marked additionally by approx. 5 mm longer lead.

### ETPW 1-6

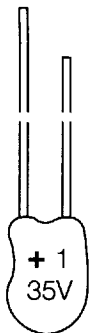



ETPW

Case size	Rated cap.	Rated voltage	Category voltage	Dimensions					Leakage current after 5 min. at +20°C	Impedance at 100 kHz +20°C	Dissipation factor at 120 Hz +20°C	Article-No.
	$C_R$	$U_R$	$U_C$	D max.	H max.	H <sub>2</sub> max.	RM ±0,5	d ±0,05	$I_R$ max.	Z max.	tan δ max.	
	μF	V-	V-	mm	mm	mm	mm	mm	μA	Ω		
1A	6,8	3	2	4,5	7,5	10,5	2,5	0,5	0,5	6	0,06	P1A 685003 M 00
1A	10	3	2	4,5	7,5	10,5	2,5	0,5	0,5	5	0,08	P1A 106003 M 00
1B	15	3	2	4,5	7,5	10,5	2,5	0,5	0,5	4	0,08	P1B 156003 M 00
2C	22	3	2	5	9,5	12,5	2,5	0,5	0,7	3,2	0,08	P2C 226003 M 00
2D	33	3	2	5	9,5	12,5	2,5	0,5	1	2,5	0,08	P2D 336003 M 00
2E	47	3	2	5	9,5	12,5	2,5	0,5	1,4	2	0,08	P2E 476003 M 00
3F	68	3	2	6	10,5	13,5	2,5	0,5	2	1,6	0,08	P3F 686003 M 00
3G	100	3	2	6	10,5	13,5	2,5	0,5	3	1,2	0,10	P3G 107003 M 00
4H	150	3	2	6,5	11,5	14,5	2,5	0,5	4,5	1	0,10	P4H 157003 M 00
5J	220	3	2	9	14	17	5	0,5	6,6	0,8	0,10	P5J 227003 M 00
5L	330	3	2	9	14	17	5	0,5	9,9	0,6	0,10	P5L 337003 M 00
1A	4,7	6,3	4	4,5	7,5	10,5	2,5	0,5	0,5	6	0,06	P1A 475603 M 00
1B	6,8	6,3	4	4,5	7,5	10,5	2,5	0,5	0,5	5	0,06	P1B 685603 M 00
2C	10	6,3	4	5	9,5	12,5	2,5	0,5	0,6	4	0,08	P2C 106603 M 00
2D	15	6,3	4	5	9,5	12,5	2,5	0,5	0,9	3,2	0,08	P2D 156603 M 00
2E	22	6,3	4	5	9,5	12,5	2,5	0,5	1,4	2,5	0,08	P2E 226603 M 00
3F	33	6,3	4	6	10,5	13,5	2,5	0,5	2,1	2	0,08	P3F 336603 M 00
3G	47	6,3	4	6	10,5	13,5	2,5	0,5	3	1,6	0,08	P3G 476603 M 00
4H	68	6,3	4	6,5	11,5	14,5	2,5	0,5	4,3	1,2	0,08	P4H 686603 M 00
5J	100	6,3	4	9	14	17	5	0,5	6,3	1	0,10	P5J 107603 M 00
5L	150	6,3	4	9	14	17	5	0,5	9,5	0,8	0,10	P5L 157603 M 00
6M	220	6,3	4	9,5	17	20	5	0,5	13,9	0,6	0,10	P6M 227603 M 00
6P	330	6,3	4	9,5	17	20	5	0,5	20,8	0,5	0,10	P6P 337603 M 00
1A	3,3	10	6,3	4,5	7,5	10,5	2,5	0,5	0,5	6,5	0,06	P1A 335010 M 00
1B	4,7	10	6,3	4,5	7,5	10,5	2,5	0,5	0,5	5	0,06	P1B 475010 M 00
2C	6,8	10	6,3	5	9,5	12,5	2,5	0,5	0,7	4	0,06	P2C 685010 M 00
2D	10	10	6,3	5	9,5	12,5	2,5	0,5	1	3,2	0,08	P2D 106010 M 00
2E	15	10	6,3	5	9,5	12,5	2,5	0,5	1,5	2,5	0,08	P2E 156010 M 00
3F	22	10	6,3	6	10,5	13,5	2,5	0,5	2,2	2	0,08	P3F 226010 M 00
3G	33	10	6,3	6	10,5	13,5	2,5	0,5	3,3	1,6	0,08	P3G 336010 M 00
4H	47	10	6,3	6,5	11,5	14,5	2,5	0,5	4,7	1,2	0,08	P4H 476010 M 00
5J	68	10	6,3	9	14	17	5	0,5	6,8	1	0,08	P5J 686010 M 00
5L	100	10	6,3	9	14	17	5	0,5	10	0,8	0,10	P5L 107010 M 00

Ordering example: P1A 685003 M 00

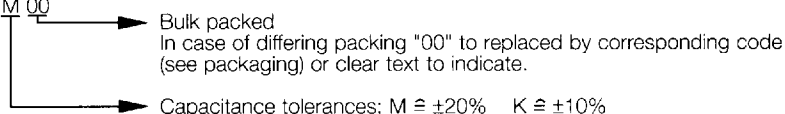

**ETPW**

Case size	Rated cap.	Rated voltage	Category voltage	Dimensions					Leakage current after 5 min. at +20°C	Impe-dance at 100 kHz +20°C	Dissipa-tion factor at 120 Hz +20°C	Article-No.
	$C_R$	$U_R$	$U_C$	D max.	H max.	H <sub>2</sub> max.	RM ±0,5	d ±0,05	$I_R$ max.	Z max.	$\tan \delta$ max.	
	$\mu F$	V-	V-	mm	mm	mm	mm	mm	$\mu A$	$\Omega$		
6N	150	10	6,3	9,5	17	20	5	0,5	15	0,6	0,10	P6N 157010 M 00
6P	220	10	6,3	9,5	17	20	5	0,5	22	0,5	0,10	P6P 227010 M 00
1A	2,2	16	10	4,5	7,5	10,5	2,5	0,5	0,5	7	0,06	P1A 225016 M 00
1B	3,3	16	10	4,5	7,5	10,5	2,5	0,5	0,5	6	0,06	P1B 335016 M 00
2C	4,7	16	10	5	9,5	12,5	2,5	0,5	0,8	4,5	0,06	P2C 475016 M 00
2D	6,8	16	10	5	9,5	12,5	2,5	0,5	1,1	3,2	0,06	P2D 685016 M 00
2E	10	16	10	5	9,5	12,5	2,5	0,5	1,6	2,5	0,08	P2E 106016 M 00
3F	15	16	10	6	10,5	13,5	2,5	0,5	2,4	2	0,08	P3F 156016 M 00
3G	22	16	10	6	10,5	13,5	2,5	0,5	3,5	1,6	0,08	P3G 226016 M 00
4H	33	16	10	6,5	11,5	14,5	2,5	0,5	5,3	1,2	0,08	P4H 336016 M 00
5K	47	16	10	9	14	17	5	0,5	7,5	1	0,08	P5K 476016 M 00
5L	68	16	10	9	14	17	5	0,5	10,9	0,8	0,08	P5L 686016 M 00
6N	100	16	10	9,5	17	20	5	0,5	16	0,6	0,10	P6N 107016 M 00
6R	150	16	10	9,5	17	20	5	0,5	24	0,5	0,10	P6R 157016 M 00
1A	1	25	16	4,5	7,5	10,5	2,5	0,5	0,5	8,5	0,04	P1A 105025 M 00
1A	1,5	25	16	4,5	7,5	10,5	2,5	0,5	0,5	7,5	0,04	P1A 155025 M 00
1B	2,2	25	16	4,5	7,5	10,5	2,5	0,5	0,6	6	0,06	P1B 225025 M 00
2C	3,3	25	16	5	9,5	12,5	2,5	0,5	0,8	4,5	0,06	P2C 335025 M 00
2D	4,7	25	16	5	9,5	12,5	2,5	0,5	1,2	3,2	0,06	P2D 475025 M 00
2E	6,8	25	16	5	9,5	12,5	2,5	0,5	1,7	2,5	0,06	P2E 685025 M 00
3F	10	25	16	6	10,5	13,5	2,5	0,5	2,5	2	0,08	P3F 106025 M 00
4H	15	25	16	6,5	11,5	14,5	2,5	0,5	3,8	1,6	0,08	P4H 156025 M 00
5J	22	25	16	9	14	17	5	0,5	5,5	1,2	0,08	P5J 226025 M 00
5K	33	25	16	9	14	17	5	0,5	8,3	1	0,08	P5K 336025 M 00
6M	47	25	16	9,5	17	20	5	0,5	11,8	0,8	0,08	P6M 476025 M 00
6N	68	25	16	9,5	17	20	5	0,5	17	0,6	0,08	P6N 686025 M 00
1A	0,1	35	23	4,5	7,5	10,5	2,5	0,5	0,5	38	0,04	P1A 104035 M 00
1A	0,15	35	23	4,5	7,5	10,5	2,5	0,5	0,5	30	0,04	P1A 154035 M 00
1A	0,22	35	23	4,5	7,5	10,5	2,5	0,5	0,5	23	0,04	P1A 224035 M 00
1A	0,33	35	23	4,5	7,5	10,5	2,5	0,5	0,5	18	0,04	P1A 334035 M 00
1A	0,47	35	23	4,5	7,5	10,5	2,5	0,5	0,5	14	0,04	P1A 474035 M 00
1A	0,68	35	23	4,5	7,5	10,5	2,5	0,5	0,5	10	0,04	P1A 684035 M 00
1A	1	35	23	4,5	7,5	10,5	2,5	0,5	0,5	8	0,04	P1A 105035 M 00

Ordering example: P1A 685003 M 00

Bulk packed  
 In case of differing packing "00" to be replaced by corresponding code (see packaging) or clear text to indicate.  
 Capacitance tolerances: M  $\cong$   $\pm$ 20% K  $\cong$   $\pm$ 10%

**Roederstein**

ETPW

Case size	Rated cap.	Rated voltage	Category voltage	Dimensions					Leakage current after 5 min. at +20°C	Impe-dance at 100 kHz +20°C	Dissipa-tion factor at 120 Hz +20°C	Article-No.
	$C_R$	$U_R$	$U_C$	D max.	H max.	H <sub>2</sub> max.	RM ±0,5	d ±0,05	$I_R$ max.	Z max.	$\tan \delta$ max.	
	$\mu F$	V-	V-	mm	mm	mm	mm	mm	$\mu A$	$\Omega$		
1B	1,5	35	23	4,5	7,5	10,5	2,5	0,5	0,5	6,5	0,04	P1B 155035 M 00
2C	2,2	35	23	5	9,5	12,5	2,5	0,5	0,8	5	0,06	P2C 225035 M 00
2D	3,3	35	23	5	9,5	12,5	2,5	0,5	1,2	3,5	0,06	P2D 335035 M 00
2E	4,7	35	23	5	9,5	12,5	2,5	0,5	1,6	2,5	0,06	P2E 475035 M 00
3F	6,8	35	23	6	10,5	13,5	2,5	0,5	2,4	2	0,06	P3F 685035 M 00
3G	10	35	23	6	10,5	13,5	2,5	0,5	3,5	1,6	0,08	P3G 106035 M 00
5J	15	35	23	9	14	17	5	0,5	5,3	1,2	0,08	P5J 156035 M 00
5L	22	35	23	9	14	17	5	0,5	7,7	1	0,08	P5L 226035 M 00
6M	33	35	23	9,5	17	20	5	0,5	11,6	0,8	0,08	P6M 336035 M 00
6P	47	35	23	9,5	17	20	5	0,5	16,5	0,6	0,08	P6P 476035 M 00
1A	0,1	50	33	4,5	7,5	10,5	2,5	0,5	0,5	38	0,04	P1A 104050 M 00
1A	0,15	50	33	4,5	7,5	10,5	2,5	0,5	0,5	30	0,04	P1A 154050 M 00
1A	0,22	50	33	4,5	7,5	10,5	2,5	0,5	0,5	23	0,04	P1A 224050 M 00
1B	0,33	50	33	4,5	7,5	10,5	2,5	0,5	0,5	18	0,04	P1B 334050 M 00
1B	0,47	50	33	4,5	7,5	10,5	2,5	0,5	0,5	14	0,04	P1B 474050 M 00
2C	0,68	50	33	5	9,5	12,5	2,5	0,5	0,5	10	0,04	P2C 684050 M 00
2D	1	50	33	5	9,5	12,5	2,5	0,5	0,5	8	0,04	P2D 105050 M 00
2E	1,5	50	33	5	9,5	12,5	2,5	0,5	0,8	6,5	0,04	P2E 155050 M 00
3F	2,2	50	33	6	10,5	13,5	2,5	0,5	1,1	5	0,06	P3F 225050 M 00
3G	3,3	50	33	6	10,5	13,5	2,5	0,5	1,7	3,5	0,06	P3G 335050 M 00
4H	4,7	50	33	6,5	11,5	14,5	2,5	0,5	2,4	2,5	0,06	P4H 475050 M 00
5J	6,8	50	33	9	14	17	5	0,5	3,4	2	0,06	P5J 685050 M 00
5L	10	50	33	9	14	17	5	0,5	5	1,6	0,08	P5L 106050 M 00
6M	15	50	33	9,5	17	20	5	0,5	7,5	1,2	0,08	P6M 156050 M 00
6P	22	50	33	9,5	17	20	5	0,5	11	1	0,08	P6P 226050 M 00

**Lead styles and packing:**

Sizes	Code	p.c.m [mm] ±0,5	Clear text
1-6	00	2,5 / 5	Bulk packed
1-6	A0	5	"S" style
1-4	A1	5	"DS" style
1-4	W0	2,5	Reel, positive pole in tape run direction in front.
1-4	T0	2,5	Reel, negative pole in tape run direction in front.
1-4	H0	2,5	Ammo
1-5	V2	5	Reel, positive pole in tape run direction in front.
1-5	R0	5	Reel, negative pole in tape run direction in front.
1-5	O8	5	Ammo

Taping see page 8  
 Reel with positiv pole in tape run direction in front is standard !

**Packaging units:**  
 See page 10

**ETPW**

**Diagram 1:** Capacitance change versus temperature (standard value)

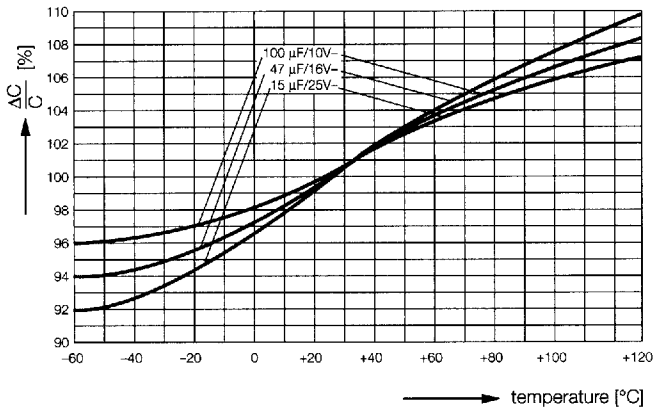

**Diagram 4:** Dissipation factor versus temperature (standard value)

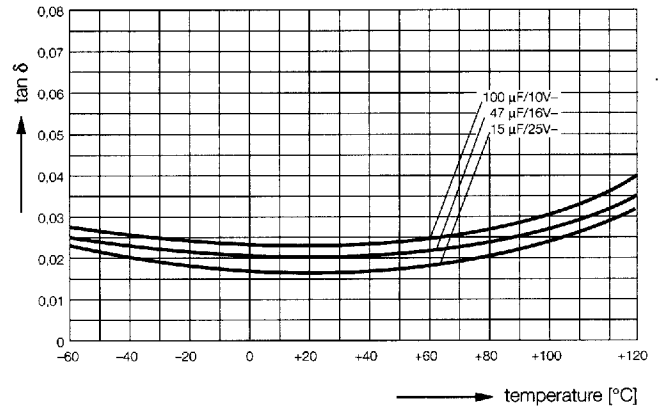

**Diagram 2:** Capacitance change versus frequency (standard value)  
ETPW with 6,3 V-

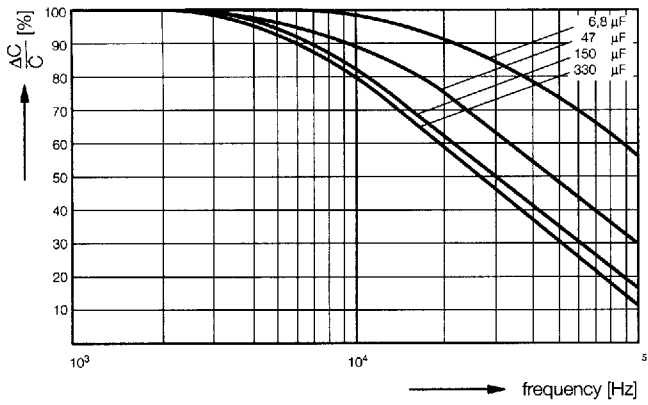

**Diagram 5:** Dissipation factor versus frequency (standard value)  
ETPW with 6,3 V-

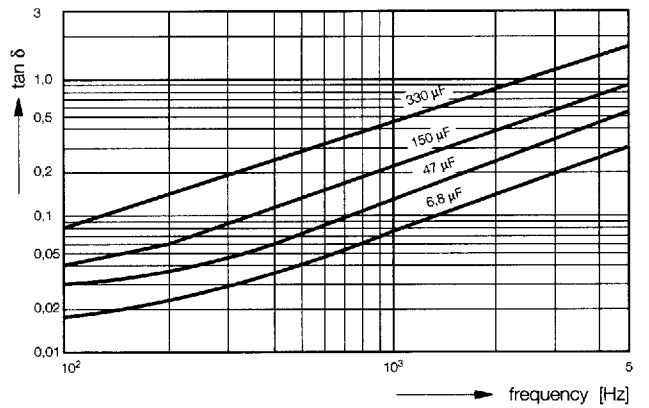

**Diagram 3:** Capacitance change versus frequency (standard value)  
ETPW with 35 V-

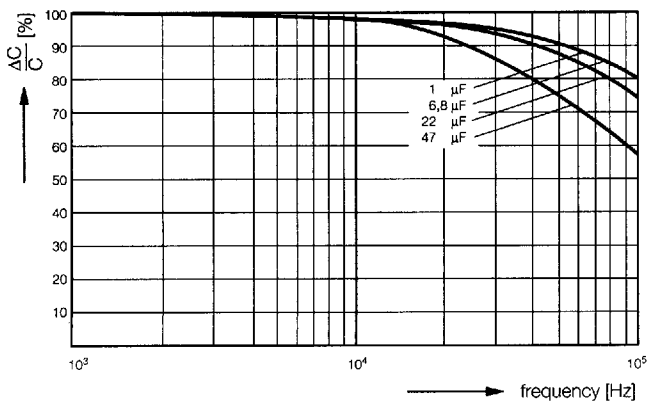

**Diagram 6:** Dissipation factor versus frequency (standard value)  
ETPW with 35 V-

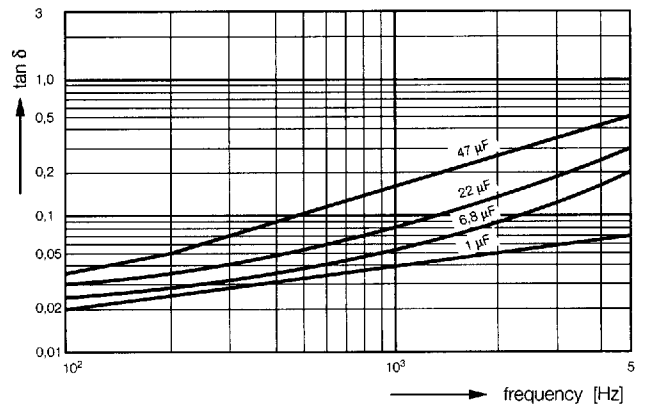



## ETPW

**Diagram 7:** Impedance at 10 and 100 kHz versus temperature (standard value)  
ETPW with 6,3 V-

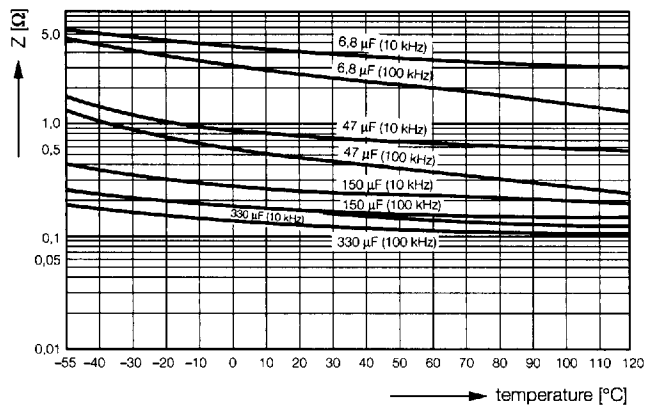

**Diagram 10:** ESR at 10 and 100 kHz versus temperature (standard value)  
ETPW with 6,3 V-

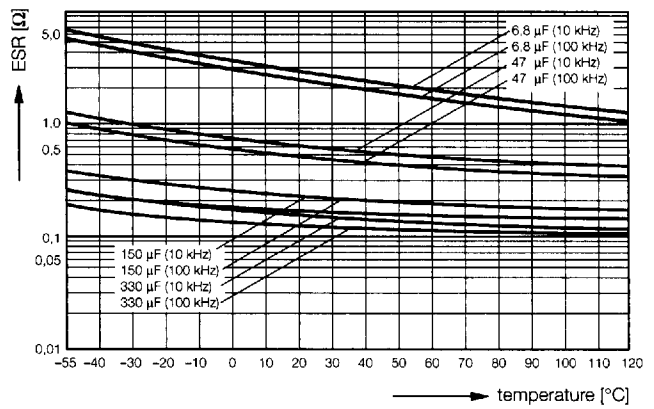

**Diagram 8:** Impedance at 10 and 100 kHz versus temperature (standard value)  
ETPW with 35 V-

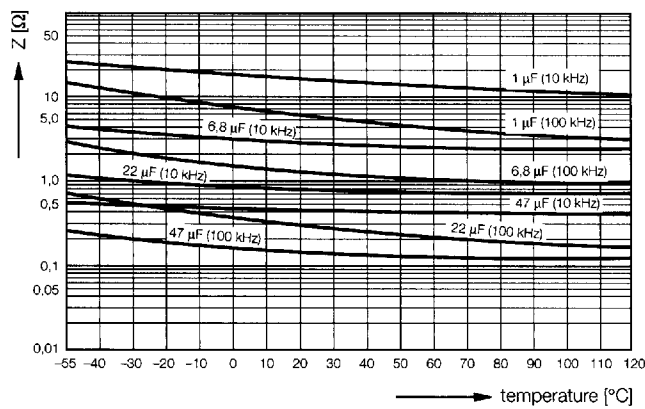

**Diagram 11:** ESR at 10 and 100 kHz versus temperature (standard value)  
ETPW with 35 V-

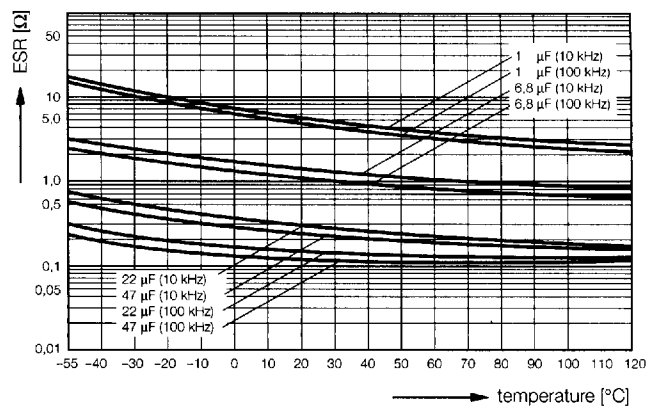

**Diagram 9:** Typical behaviour of impedance versus frequency (standard value)  
ETPW with 6,3 V-

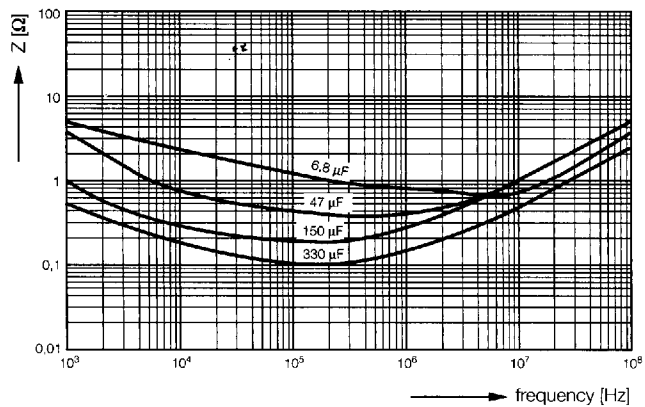

**Diagram 12:** Typical behaviour of ESR versus frequency (standard value)  
ETPW with 6,3 V-

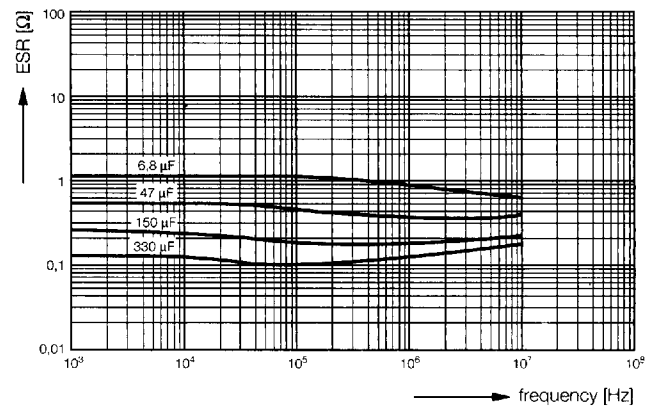



**ETPW**

**Diagram 13:** Typical behaviour of impedance versus frequency (standard value) ETPW with 35 V-

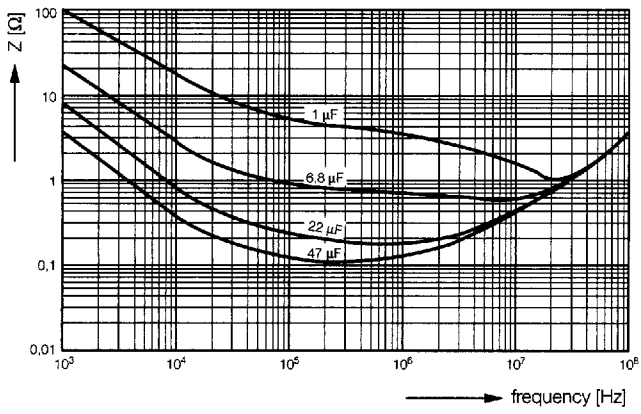

**Diagram 14:** Typical behaviour of ESR versus frequency (standard value) ETPW with 35 V-

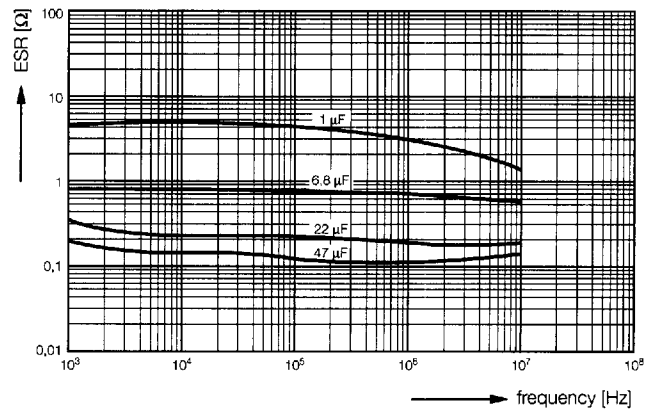



## ETPW

**Diagram 15:** Permissible superimposed AC voltage versus rated voltage and frequency at +20°C ETPW 1

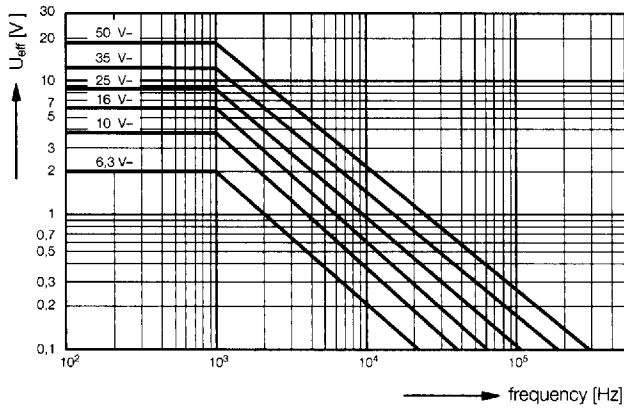

**Diagram 18:** Permissible superimposed AC voltage versus rated voltage and frequency at +20°C ETPW 4

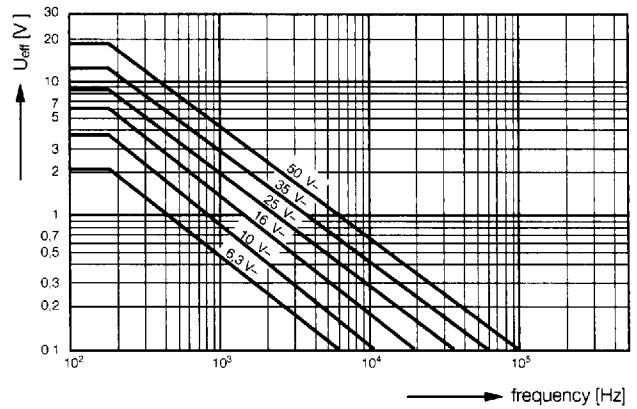

**Diagram 16:** Permissible superimposed AC voltage versus rated voltage and frequency at +20°C ETPW 2

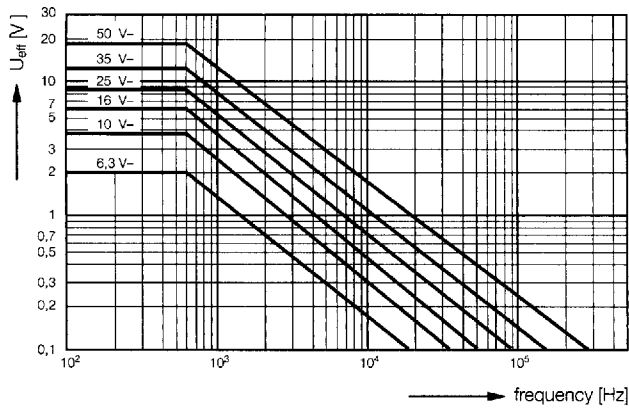

**Diagram 19:** Permissible superimposed AC voltage versus rated voltage and frequency at +20°C ETPW 5/6

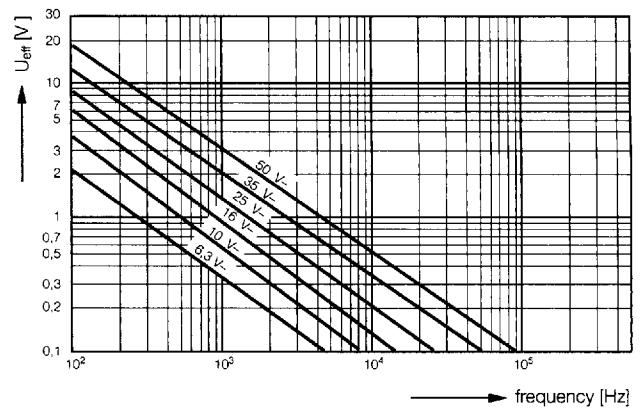

**Diagram 17:** Permissible superimposed AC voltage versus rated voltage and frequency at +20°C ETPW 3

