P4M800 Pro-M7

FCC Information and Copyright

This equipment has been tested and found to comply with the limits of a Class B digital device, pursuant to Part 15 of the FCC Rules. These limits are designed to provide reasonable protection against harmful interference in a residential installation. This equipment generates, uses and can radiate radio frequency energy and, if not installed and used in accordance with the instructions, may cause harmful interference to radio communications. There is no guarantee that interference will not occur in a particular installation.

The vendor makes no representations or warranties with respect to the contents here and specially disclaims any implied warranties of merchantability or fitness for any purpose. Further the vendor reserves the right to revise this publication and to make changes to the contents here without obligation to notify any party beforehand.

Duplication of this publication, in part or in whole, is not allowed without first obtaining the vendor's approval in writing.

The content of this user's manual is subject to be changed without notice and we will not be responsible for any mistakes found in this user's manual. All the brand and product names are trademarks of their respective companies.

Table of Contents

Chapter 1: Introduction		1
1.1	Features.....	1
1.2	Package List.....	3
1.3	Layout	4
Chapter 2: Hardware Installation		5
2.1	Installing Central Processing Unit (CPU)	5
2.2	FAN Headers	7
2.3	Installing System Memory	8
2.4	Connectors and Slots	9
Chapter 3: Headers & Jumpers Setup		12
3.1	How to Setup Jumpers	12
3.2	Detail Settings	12
Chapter 4: Useful Help.....		18
4.1	Award BIOS Beep Code	18
4.2	Extra Information	18
4.3	Troubleshooting	20
Chapter 5: WarpSpeeder™		21
5.1	Introduction	21
5.2	System Requirement	21
5.3	Installation.....	22
5.4	[WarpSpeeder™] includes 1 tray icon and 5 panels.....	23

P4M800 Pro-M7

CHAPTER 1: INTRODUCTION

1.1 FEATURES

CPU

- Supports LGA 775.
- Supports Intel Pentium 4 processor up to 3.8GHz.
- Supports Dual Core CPU.
- Front side bus at the following frequency ranges:
 - 400MHz (100MHz Core Clock)
 - 533MHz (133MHz Core Clock)
 - 800MHz (200MHz Core Clock)
 - 1066MHz (266MHz Core Clock)
- Supports Hyper-Threading Technology.

WARNING!

Warranty will be void if the pin protection cap is not in place to protect the socket pin when sending this mainboard for service.

Chipset

- North Bridge: VIA P4M800 Pro.
- South Bridge: VIA VT8237R PLUS.

Dimension

- Micro ATX Form Factor: 24.38cm (L) x 20.17cm (W)

Operating Systems

- Supports Windows 2000 and Windows XP.
- Note:** Does not support Windows 98SE and Windows ME.

Main Memory

- Supports up to two DDR2 devices.
- Supports DDR2-400/533.
- Maximum memory size is up to 2GB. (Following table is only for reference.)

DIMM Socket Location	DDR Module	Total Memory Size
DDR_A1	64MB/128MB/256MB/512MB/1GB *1	Max is 2GB.
DDR_A2	64MB/128MB/256MB/512MB/1GB *1	

P4M800 Pro-M7

Super I/O

- Chip: ITE IT8705AF
- Provides the most commonly used legacy super I/O functionality.
- Environment Control initiatives:
 - H/W Monitor.
 - Fan Speed Controller.
 - ITE “Smart Guardian” function.

On Board IDE

- Support 4 IDE disk drives.
- Supports PIO Mode 0~4.
- Supports Ultra DMA 33/66/100/133 Bus Master Mode.

10/100 LAN PHY

- PHY: RealTek RTL8201BL/RTL8201CL.
- Supports 10/100 Mb/s auto-negotiation operation.
- Half/Full duplex capability.
- Supports ACPI, PCI power management.

Serial ATA

- Integrated in VT8237R PLUS.
- Supports RAID 0 and RAID 1 functions.
- Supports 2 serial ATA (SATA) ports.
 - Compliant with SATA Version 1.0 specification.
 - Data transfer rates up to 150 MB/s.

Onboard AC'97 Sound Codec

- Chip: ALC655
- Supports 6 channels.
- Supports S/PDIF out function.
- Compliant with AC'97 Version 2.3 specification.

Slot

- 3 PCI bus master slots.
- 1 AGP 4x/8x compatible slot.
- 1 CNR slot.

P4M800 Pro-M7

Front Side Onboard Peripherals

- 1 front panel header supports front panel facilities.
- 1 S/PDIF out connector supports digital audio out function.
- 1 CD-in connector supports 1 CD-ROM audio-in device.
- 1 front audio header supports front panel audio function.
- 1 chassis open header supports PC case-opened warning function.
- 1 Floppy port supports 2 FDD with 360K, 720K, 1.2M, 1.44M and 2.88Mbytes.
- 2 USB headers support 4 USB 2.0 ports.
- 2 IDE connectors support 4 hard disk devices.
- 2 serial ATA connectors support 2 SATA devices.

Rear Side Connectors

- 4 USB 2.0 ports.
- 1 VGA port.
- 1 Serial port.
- 1 Printer port.
- 1 RJ-45 LAN jack.
- 1 PS/2 Mouse & Keyboard port.
- 1 vertical audio port including 1 line-in connector, 1 line-out connector, and 1 MIC-in connector.

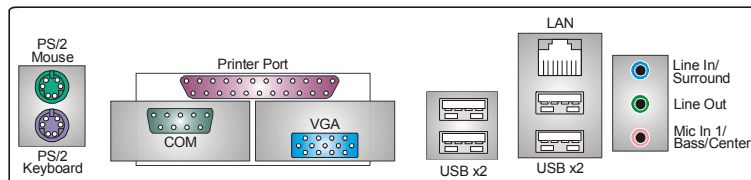

1.2 PACKAGE LIST

- FDD cable x1
- HDD cable x1
- User's Manual x1
- Fully Setup Driver CD x1
- Rear I/O panel for ATX case x1
- USB 2.0 cable x1 (optional)
- Serial ATA cable x2 (optional)
- S/PDIF out cable x1 (optional)

P4M800 Pro-M7

1.3 LAYOUT

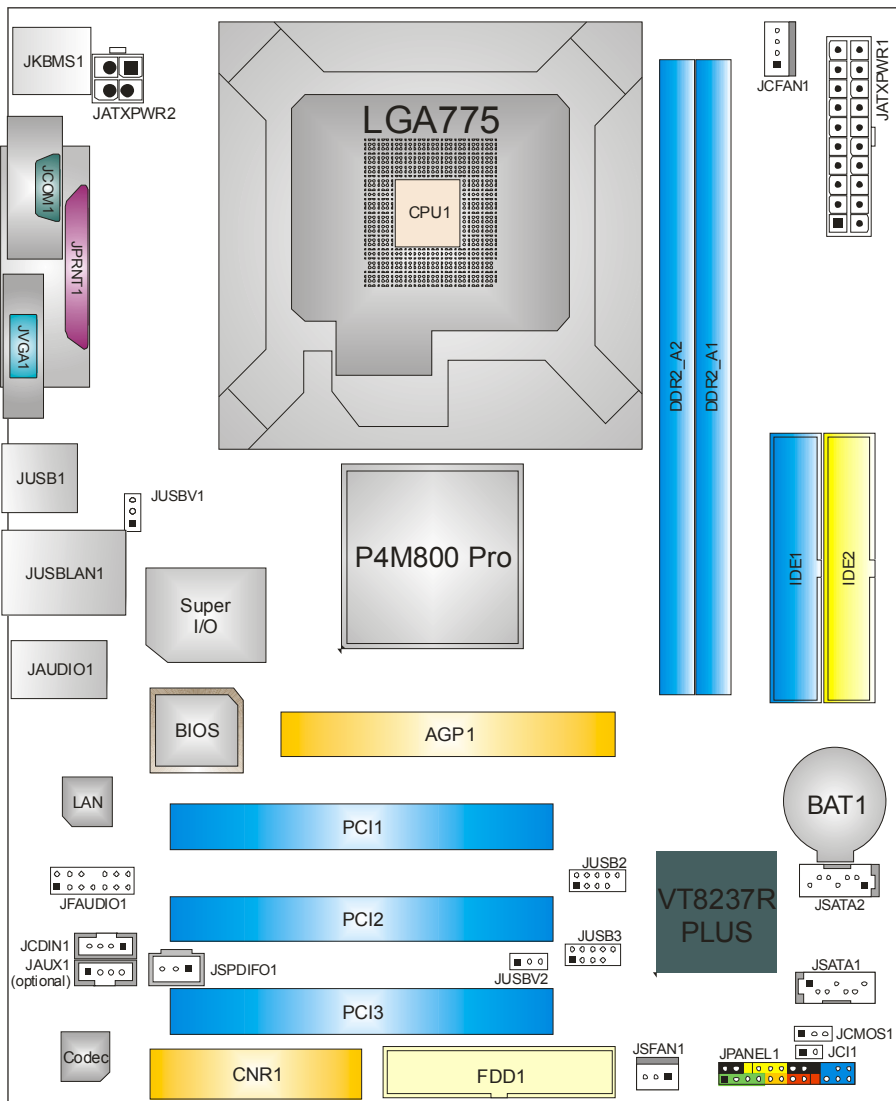

Note: ■ represents the 1st pin.

P4M800 Pro-M7

CHAPTER 2: HARDWARE INSTALLATION

2.1 INSTALLING CENTRAL PROCESSING UNIT (CPU)

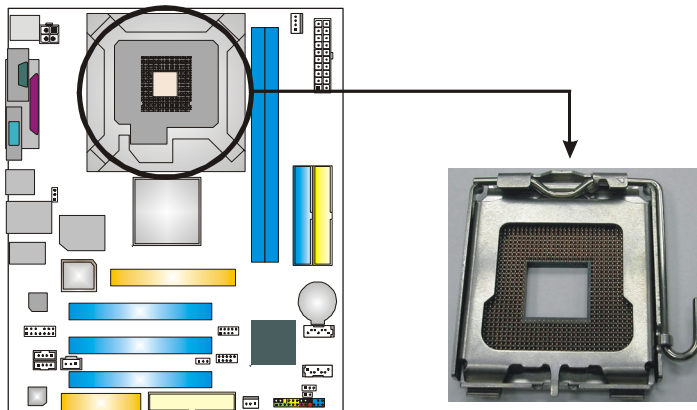

Special Notice:

Remove Pin Cap before installation, and make good preservation for future use. When the CPU is removed, cover the Pin Cap on the empty socket to ensure pin legs won't be damaged.

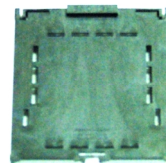

Pin Cap

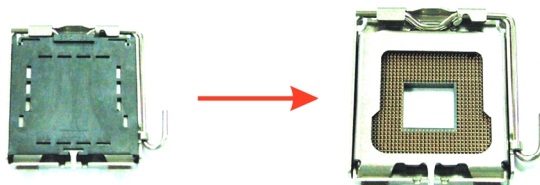

Step 1: Pull the socket locking lever out from the socket and then raise the lever up to a 90-degree angle.

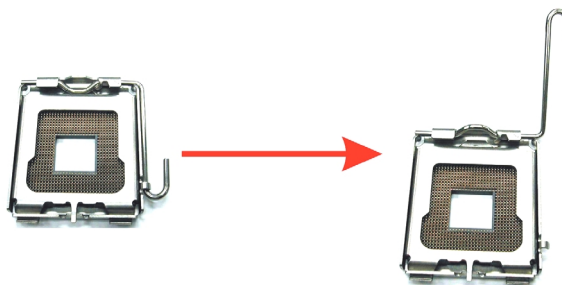

P4M800 Pro-M7

Step 2: Look for the triangular cut edge on socket, and the golden dot on CPU should point forwards this triangular cut edge. The CPU will fit only in the correct orientation.

Step 2-1:

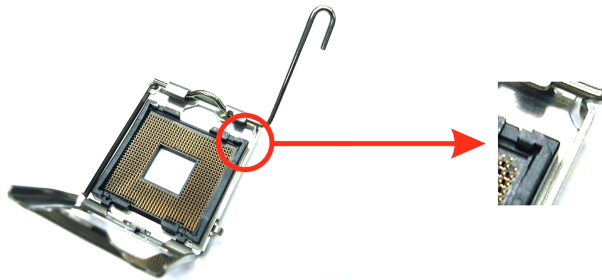

Step 2-2:

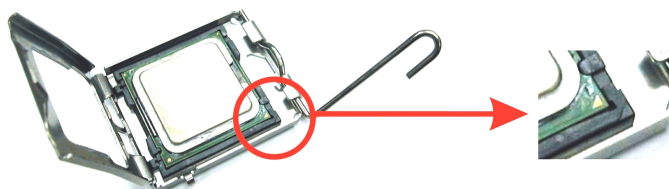

Step 3: Hold the CPU down firmly, and then lower the lever to locked position to complete the installation.



Step 4: Put the CPU Fan and heatsink assembly on the CPU and buckle it on the retention frame. Connect the CPU FAN power cable into the JCFAN1. This completes the installation.

P4M800 Pro-M7

2.2 FAN HEADERS

These fan headers support cooling-fans built in the computer. The fan cable and connector may be different according to the fan manufacturer. Connect the fan cable to the connector while matching the black wire to pin#1.

JCFAN1: CPU Fan Header

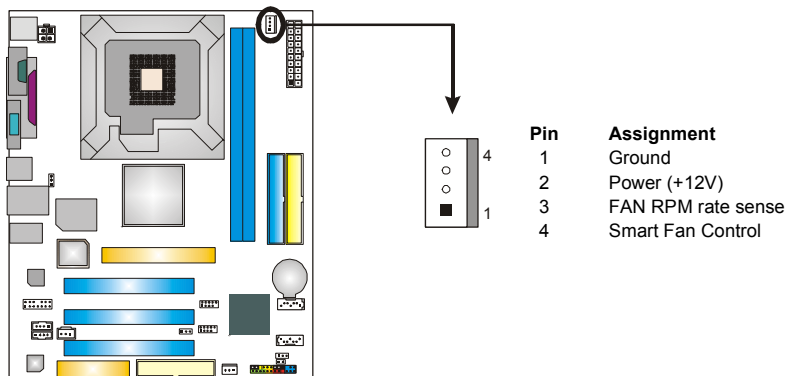

JSFAN1: System Fan Header

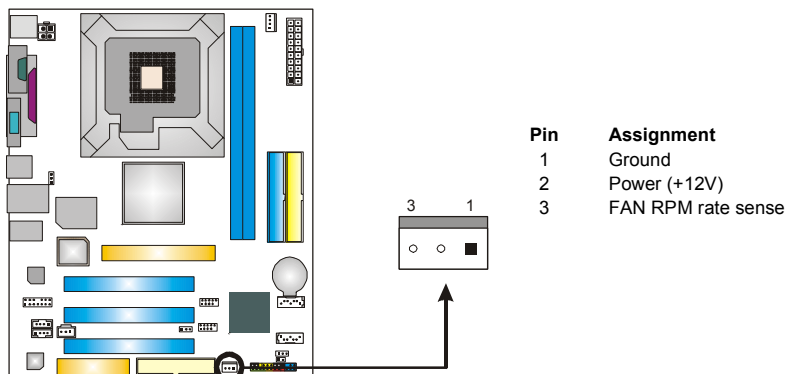

Note:

The JCFAN1 reserves system cooling fan with Smart Fan Control utility. It supports 4-pin head connector. When connecting with wires onto connectors, please note that the red wire is the positive and should be connected to pin#2, and the black wire is Ground and should be connected to GND.

P4M800 Pro-M7

2.3 INSTALLING SYSTEM MEMORY

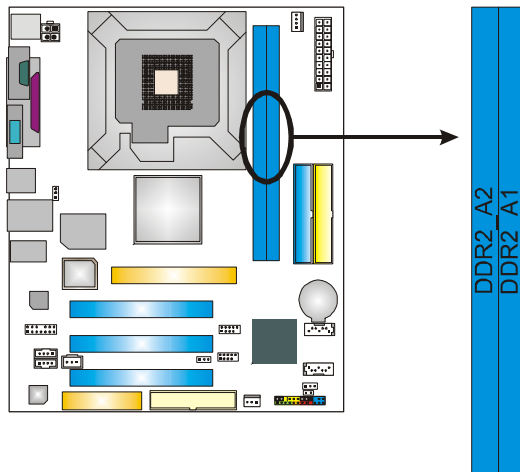

1. Unlock a DIMM slot by pressing the retaining clips outward. Align a DIMM on the slot such that the notch on the DIMM matches the break on the Slot.

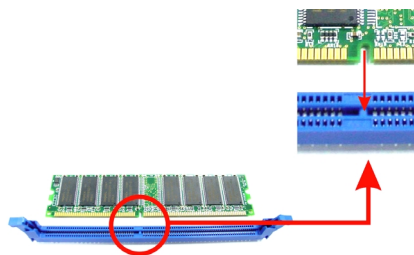

2. Insert the DIMM vertically and firmly into the slot until the retaining chip snap back in place and the DIMM is properly seated.

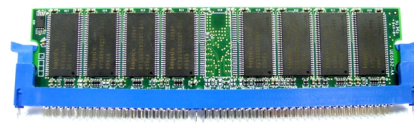

P4M800 Pro-M7

2.4 CONNECTORS AND SLOTS**FDD1: Floppy Disk Connector**

The motherboard provides a standard floppy disk connector that supports 360K, 720K, 1.2M, 1.44M and 2.88M floppy disk types. This connector supports the provided floppy drive ribbon cables.

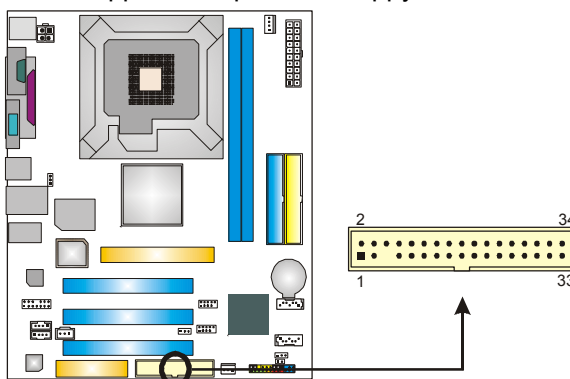
**IDE1/IDE2: Hard Disk Connectors**

The motherboard has a 32-bit Enhanced PCI IDE Controller that provides PIO Mode 0~4, Bus Master, and Ultra DMA 33/66/100/133 functionality.

The IDE connectors can connect a master and a slave drive, so you can connect up to two hard disk drives. The first hard drive should always be connected to IDE1.

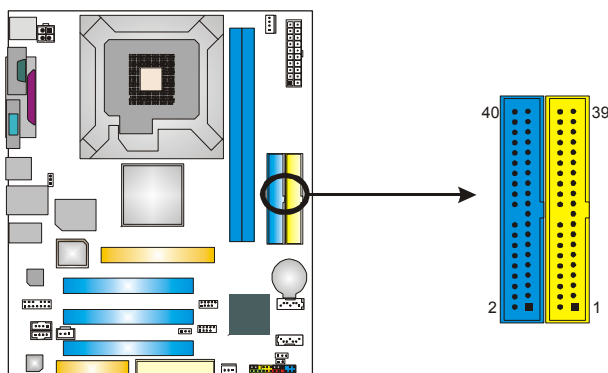

P4M800 Pro-M7

PCI1~PCI3: Peripheral Component Interconnect Slots

This motherboard is equipped with 3 standard PCI slots. PCI stands for Peripheral Component Interconnect, and it is a bus standard for expansion cards. This PCI slot is designated as 32 bits.

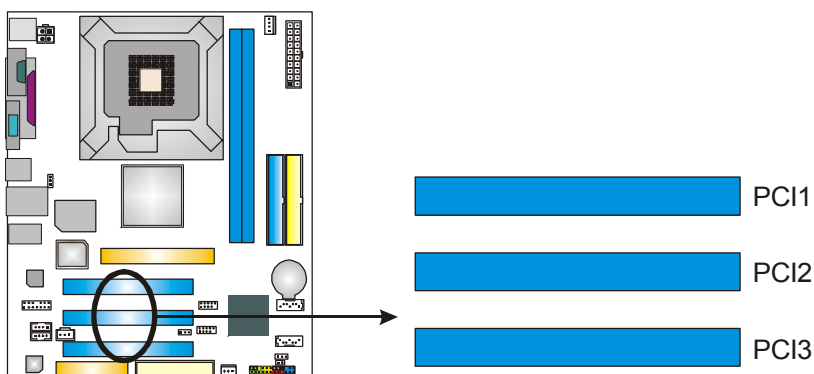

AGP1: Accelerated Graphics Port Slot

Your monitor will attach directly to that video card. This motherboard supports video cards for PCI slots, but it is also equipped with an Accelerated Graphics Port (AGP). An AGP card will take advantage of AGP technology for improved video efficiency and performance, especially with 3D graphics.

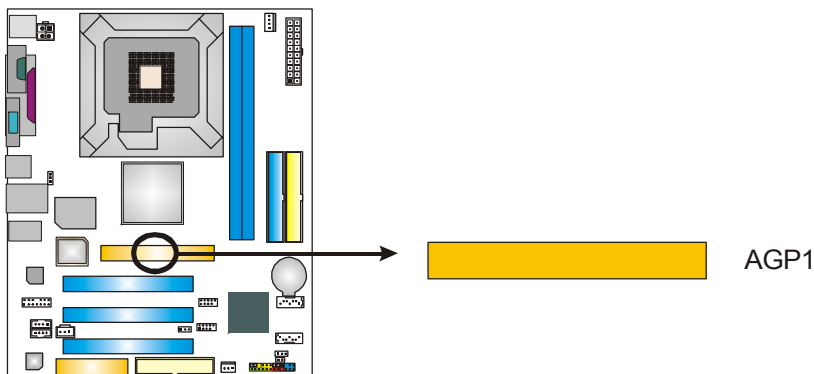

P4M800 Pro-M7

CNR1: Communication Network Riser Slot

The CNR specification is an open Industry Standard Architecture, and it defines a hardware scalable riser card interface, which supports modem only.

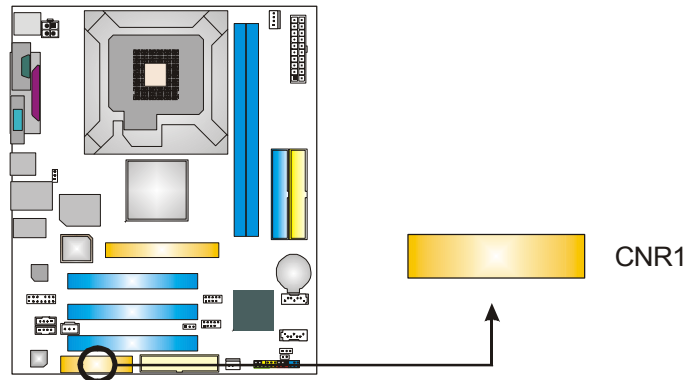

P4M800 Pro-M7

CHAPTER 3: HEADERS & JUMPERS SETUP

3.1 HOW TO SETUP JUMPERS

The illustration shows how to set up jumpers. When the jumper cap is placed on pins, the jumper is “close”, if not, that means the jumper is “open”.



Pin opened



Pin closed

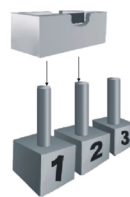

Pin1-2 closed

3.2 DETAIL SETTINGS

JUSBV1/JUSBV2: Power Source Headers for USB ports

Pin 1-2 Close:

JUSBV1: +5V for USB ports at JUSB1 and JUSBLAN1.

JUSBV2: +5V for USB ports at front panel (JUSB2/JUSB3).

Pin 2-3 Close:

JUSBV1: USB ports at JUSB1 and JUSBLAN1 are powered by +5V standby voltage.

JUSBV2: USB ports at front panel (JUSB2/JUSB3) are powered by +5V standby voltage.

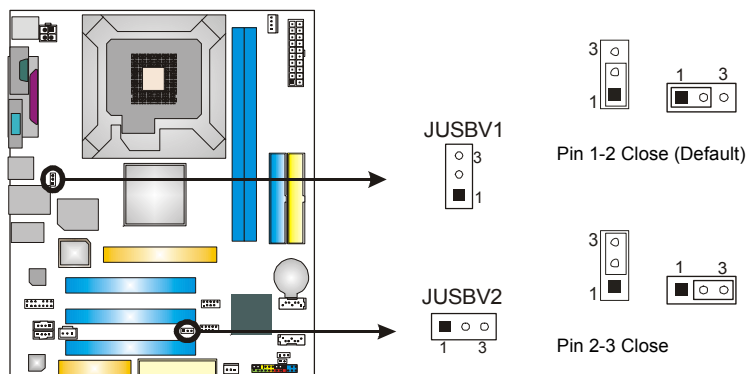

Note:

In order to support this function “Power-On system via USB device,” “JUSBV1/ JUSBV2” jumper cap should be placed on Pin 2-3 individually.

P4M800 Pro-M7

JATXPWR1: ATX Power Source Connector

This connector allows user to connect 20-pin power connector on the ATX power supply.

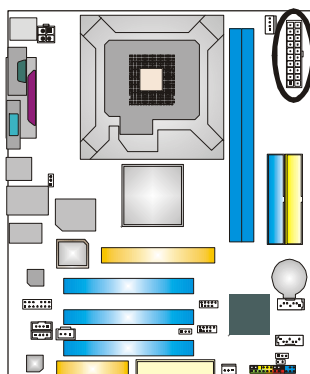

Pin	Assignment
1	+3.3V
2	+3.3V
3	Ground
4	+5V
5	Ground
6	+5V
7	Ground
8	PW_OK
9	Standby Voltage +5V
10	+12V
11	+3.3V
12	-12V
13	Ground
14	PS_ON
15	Ground
16	Ground
17	Ground
18	-5V
19	+5V
20	+5V

JATXPWR2: ATX Power Source Connector

By connecting this connector, it will provide +12V to CPU power circuit.

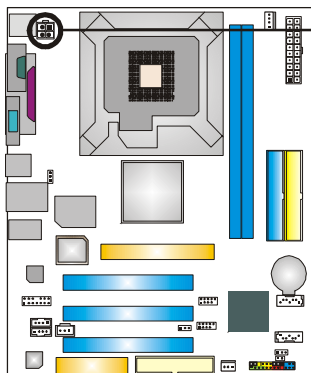

Pin	Assignment
1	+12V
2	+12V
3	Ground
4	Ground

P4M800 Pro-M7

JUSB2/JUSB3: Headers for USB 2.0 Ports at Front Panel

This header allows user to connect additional USB cable on the PC front panel, and also can be connected with internal USB devices, like USB card reader.

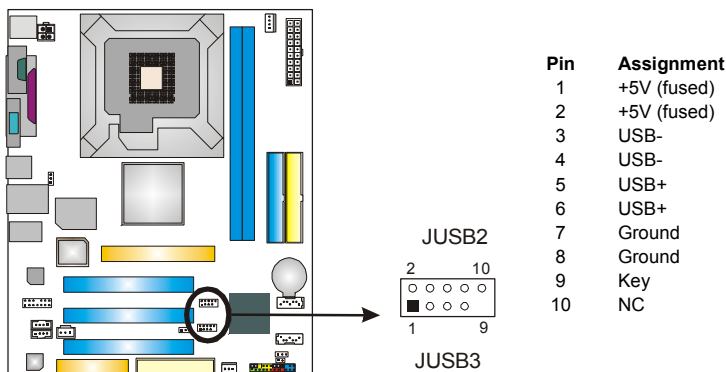

JPANEL1: Front Panel Header

This 24-pin connector includes Power-on, Reset, HDD LED, Power LED, Sleep button, speaker and IrDA Connection. It allows user to connect the PC case's front panel switch functions.

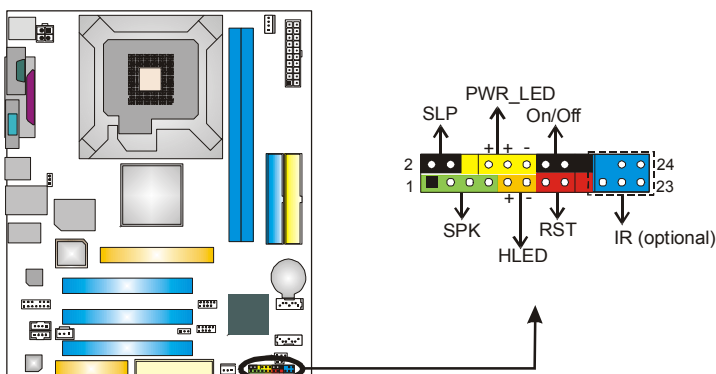

Pin	Assignment	Function	Pin	Assignment	Function
1	+5V	Speaker Connector	2	Sleep control	Sleep button
3	N/A		4	Ground	
5	N/A		6	N/A	N/A
7	Speaker	Hard drive LED	8	Power LED (+)	Power LED
9	HDD LED (+)		10	Power LED (+)	
11	HDD LED (-)		12	Power LED (-)	
13	Ground	Reset button	14	Power button	Power-on button
15	Reset control		16	Ground	
17	N/A	IrDA Connector (optional)	18	N/A	
19	N/A		20	Key	
21	+5V		22	Ground	
23	IRTX		24	IRRX	

P4M800 Pro-M7

JCDIN1: CD-ROM Audio-in Connector

This connector allows user to connect the audio source from the variety devices, like CD-ROM, DVD-ROM, PCI sound card, PCI TV turner card etc..

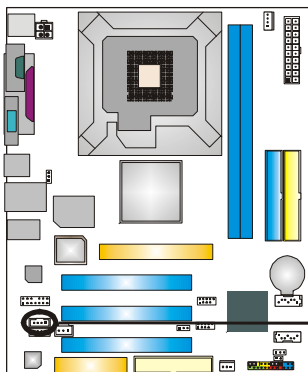

Pin	Assignment
1	Left Channel Input
2	Ground
3	Ground
4	Right Channel Input

JFAUDIO1: Front Panel Audio Header

This header allows user to connect the front audio output cable with the PC front panel. It will disable the output on back panel audio connectors.

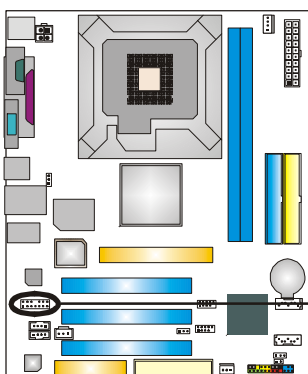

Pin	Assignment
1	Mic-in/Stereo MIC-in R
2	Ground
3	Stereo MIC-in L
4	Audio power
5	Right line-out/ Speaker-out Right
6	Right line-out/ Speaker-out Right
7	Reserved
8	Key
9	Left line-out/ Speaker-out Left
10	Left line-out/ Speaker-out Left
11	Right line-in (optional)
12	Right line-in (optional)
13	Left line-in (optional)
14	Left line-in (optional)

P4M800 Pro-M7

JCMOS1: Clear CMOS Header

By placing the jumper on pin2-3, it allows user to restore the BIOS safe setting and the CMOS data, please carefully follow the procedures to avoid damaging the motherboard.

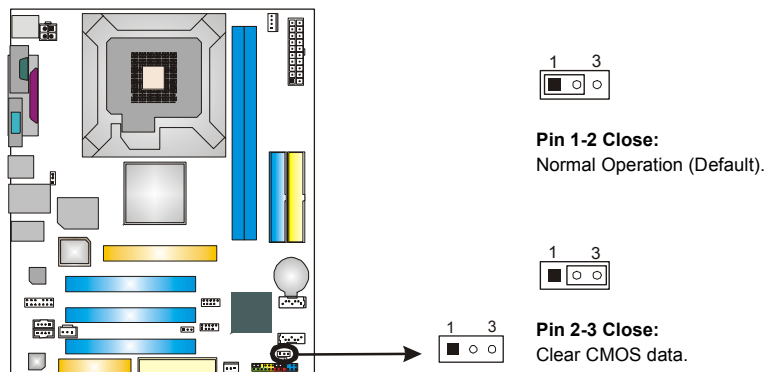

※ Clear CMOS Procedures:

1. Remove AC power line.
2. Set the jumper to "Pin 2-3 Close".
3. Wait for five seconds.
4. Set the jumper to "Pin 1-2 Close".
5. Power on the AC.
6. Reset your desired password or clear the CMOS data.

JCI1: Chassis Open Header

This connector allows system to monitor PC case open status. If the signal has been triggered, it will record to the CMOS and show the message on next boot-up.

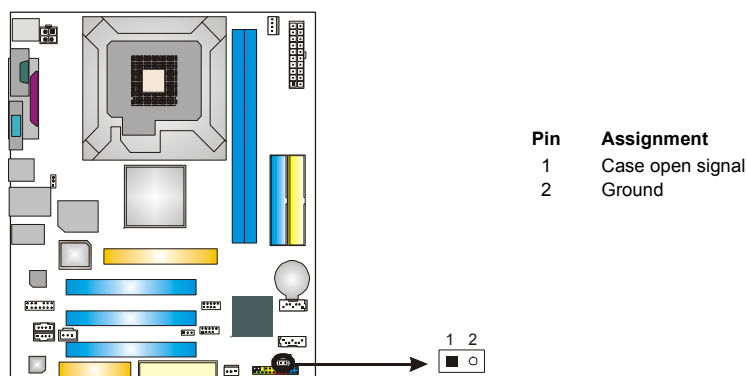

P4M800 Pro-M7

JSATA1~JSATA2: Serial ATA Connectors

The motherboard has a PCI to SATA Controller with 2 channels SATA interface, it satisfies the SATA 1.0 spec and with transfer rate of 1.5GB/s.

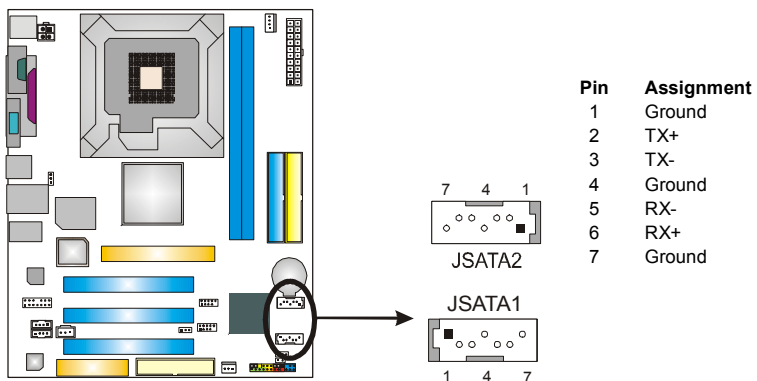

JSPDIFO1: Digital Audio-out Connector

This connector allows user to connect the PCI bracket SPDIF output header.

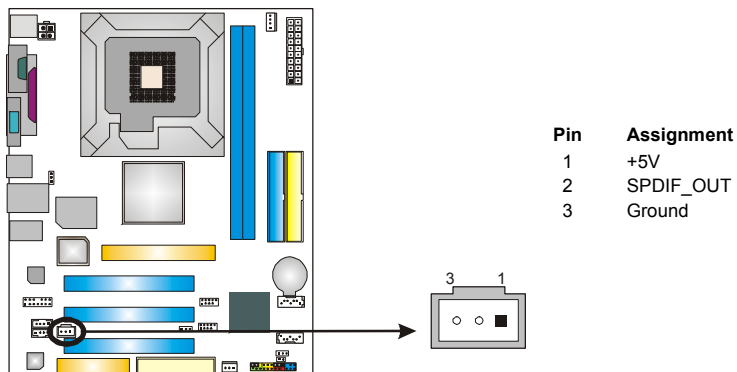

P4M800 Pro-M7

CHAPTER 4: USEFUL HELP

4.1 AWARD BIOS BEEP CODE

Beep Sound	Meaning
One long beep followed by two short beeps	Video card not found or video card memory bad
High-low siren sound	CPU overheated System will shut down automatically
One Short beep when system boot-up	No error found during POST
Long beeps every other second	No DRAM detected or install

4.2 EXTRA INFORMATION

A. BIOS Update

After you fail to update BIOS or BIOS is invaded by virus, the Boot-Block function will help to restore BIOS. If the following message is shown after boot-up the system, it means the BIOS contents are corrupted.

```

BIOS ROM checksum error
Detecting floppy drive A media...
INSERT SYSTEM DISK AND PRESS ENTER
```

In this Case, please follow the procedure below to restore the BIOS:

1. Make a bootable floppy disk.
2. Download the Flash Utility "AWDFLASH.exe" from the Biostar website: www.biostar.com.tw
3. Confirm motherboard model and download the respectively BIOS from Biostar website.
4. Copy "AWDFLASH.exe" and respectively BIOS into floppy disk.
5. Insert the bootable disk into floppy drive and press Enter.
6. System will boot-up to DOS prompt.
7. Type "*Awdflash xxxx.bf/sn/py/r*" in DOS prompt.
(xxxx means BIOS name.)
8. System will update BIOS automatically and restart.
9. The BIOS has been recovered and will work properly.

P4M800 Pro-M7

B. CPU Overheated

If the system shutdown automatically after power on system for seconds, that means the CPU protection function has been activated.

When the CPU is over heated, the motherboard will shutdown automatically to avoid a damage of the CPU, and the system may not power on again.

In this case, please double check:

1. The CPU cooler surface is placed evenly with the CPU surface.
2. CPU fan is rotated normally.
3. CPU fan speed is fulfilling with the CPU speed.

After confirmed, please follow steps below to relief the CPU protection function.

1. Remove the power cord from power supply for seconds.
2. Wait for seconds.
3. Plug in the power cord and boot up the system.

Or you can:

1. Clear the CMOS data.
(See "Close CMOS Header: JCMOS1" section)
2. Wait for seconds.
3. Power on the system again.

P4M800 Pro-M7

4.3 TROUBLESHOOTING

Problem	Solution
1. No power to the system at all Power light don't illuminate, fan inside power supply does not turn on. 2. Indicator light on keyboard does not turn on.	1. Make sure power cable is securely plugged in. 2. Replace cable. 3. Contact technical support.
System inoperative. Keyboard lights are on, power indicator lights are lit, and hard drive is spinning.	Using even pressure on both ends of the DIMM, press down firmly until the module snaps into place.
System does not boot from hard disk drive, can be booted from optical drive.	1. Check cable running from disk to disk controller board. Make sure both ends are securely plugged in; check the drive type in the standard CMOS setup. 2. Backing up the hard drive is extremely important. All hard disks are capable of breaking down at any time.
System only boots from optical drive. Hard disk can be read and applications can be used but booting from hard disk is impossible.	1. Back up data and applications files. 2. Reformat the hard drive. Re-install applications and data using backup disks.
Screen message says "Invalid Configuration" or "CMOS Failure."	Review system's equipment. Make sure correct information is in setup.
Cannot boot system after installing second hard drive.	1. Set master/slave jumpers correctly. 2. Run SETUP program and select correct drive types. Call the drive manufacturers for compatibility with other drives.

P4M800 Pro-M7

CHAPTER 5: WARPSPEEDER™



5.1 INTRODUCTION

[WarpSpeeder™], a new powerful control utility, features three user-friendly functions including Overclock Manager, Overvoltage Manager, and Hardware Monitor.

With the Overclock Manager, users can easily adjust the frequency they prefer or they can get the best CPU performance with just one click. The Overvoltage Manager, on the other hand, helps to power up CPU core voltage and Memory voltage. The cool Hardware Monitor smartly indicates the temperatures, voltage and CPU fan speed as well as the chipset information. Also, in the About panel, you can get detail descriptions about BIOS model and chipsets. In addition, the frequency status of CPU, memory, AGP and PCI along with the CPU speed are synchronically shown on our main panel.

Moreover, to protect users' computer systems if the setting is not appropriate when testing and results in system fail or hang, [WarpSpeeder™] technology assures the system stability by automatically rebooting the computer and then restart to a speed that is either the original system speed or a suitable one.

5.2 SYSTEM REQUIREMENT

OS Support: Windows 98 SE, Windows Me, Windows 2000, Windows XP
DirectX: DirectX 8.1 or above. (The Windows XP operating system includes DirectX 8.1. If you use Windows XP, you do not need to install DirectX 8.1.)

P4M800 Pro-M7

5.3 INSTALLATION

1. Execute the setup execution file, and then the following dialog will pop up. Please click “Next” button and follow the default procedure to install.

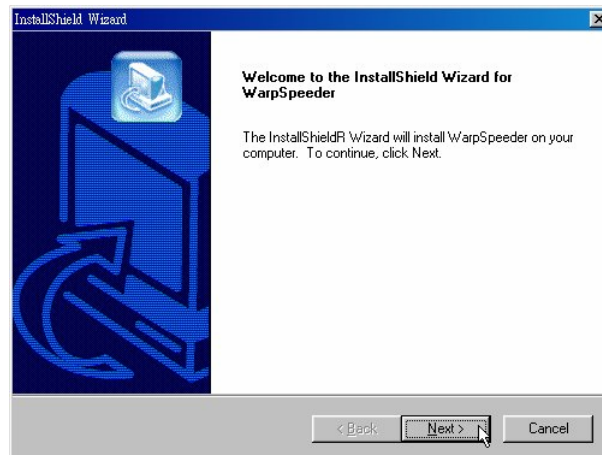

2. When you see the following dialog in setup procedure, it means setup is completed. If the “Launch the WarpSpeeder Tray Utility” checkbox is checked, the Tray Icon utility and [WarpSpeeder™] utility will be automatically and immediately launched after you click “Finish” button.

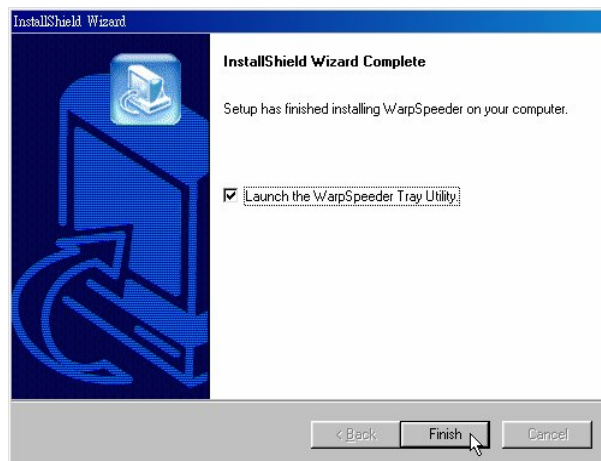

Usage:

The following figures are just only for reference, the screen printed in this user manual will change according to your motherboard on hand.

P4M800 Pro-M7

5.4 [WARPSPEEDER™] INCLUDES 1 TRAY ICON AND 5 PANELS

1. Tray Icon:

Whenever the Tray Icon utility is launched, it will display a little tray icon on the right side of Windows Taskbar.



This utility is responsible for conveniently invoking [WarpSpeeder™] Utility. You can use the mouse by clicking the left button in order to invoke [WarpSpeeder™] directly from the little tray icon or you can right-click the little tray icon to pop up a popup menu as following figure. The "Launch Utility" item in the popup menu has the same function as mouse left-click on tray icon and "Exit" item will close Tray Icon utility if selected.

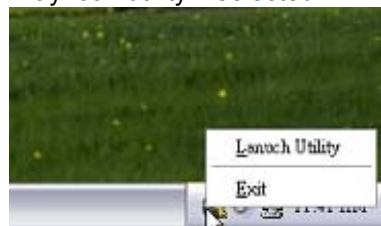

P4M800 Pro-M7

2. Main Panel

If you click the tray icon, [WarpSpeeder™] utility will be invoked. Please refer to the following figure; the utility's first window you will see is Main Panel.

Main Panel contains features as follows:

- a. Display the CPU Speed, CPU external clock, Memory clock, AGP clock, and PCI clock information.
- b. Contains About, Voltage, Overclock, and Hardware Monitor Buttons for invoking respective panels.
- c. With a user-friendly Status Animation, it can represent 3 overclock percentage stages:
 - Man walking→overclock percentage from 100% ~ 110 %
 - Panther running→overclock percentage from 110% ~ 120%
 - Car racing→overclock percentage from 120% ~ above

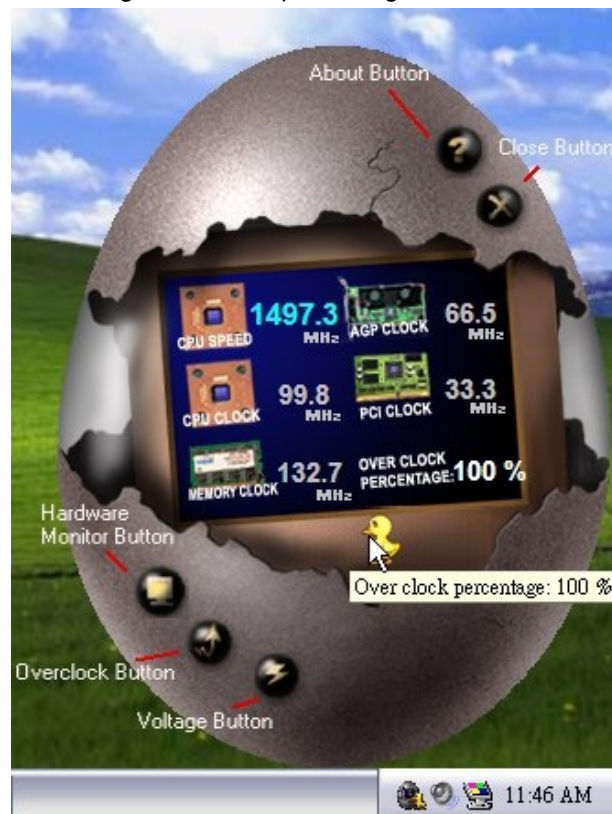

P4M800 Pro-M7

3. Voltage Panel

Click the Voltage button in Main Panel, the button will be highlighted and the Voltage Panel will slide out to up as the following figure.

In this panel, you can decide to increase CPU core voltage and Memory voltage or not. The default setting is "No". If you want to get the best performance of overclocking, we recommend you click the option "Yes".



P4M800 Pro-M7

4. Overclock Panel

Click the Overclock button in Main Panel, the button will be highlighted and the Overclock Panel will slide out to left as the following figure.



Overclock Panel contains the these features:

- a. “-3MHz button”, “-1MHz button”, “+1MHz button”, and “+3MHz button”:
provide user the ability to do real-time overclock adjustment.

Warning:

Manually overclock is potentially dangerous, especially when the overclocking percentage is over 110 %. We strongly recommend you verify every speed you overclock by click the Verify button. Or, you can just click Auto overclock button and let [WarpSpeeder™] automatically gets the best result for you.

- b. “Recovery Dialog button”: Pop up the following dialog. Let user select a restoring way if system need to do a fail-safe reboot.

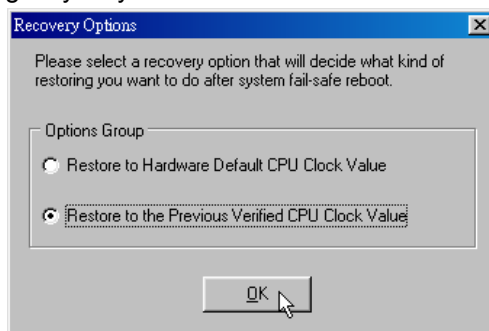

P4M800 Pro-M7

- c. “Auto-overclock button”: User can click this button and [WarpSpeeder™] will set the best and stable performance and frequency automatically. [WarpSpeeder™] utility will execute a series of testing until system fail. Then system will do fail-safe reboot by using Watchdog function. After reboot, the [WarpSpeeder™] utility will restore to the hardware default setting or load the verified best and stable frequency according to the Recovery Dialog’s setting.
- d. “Verify button”: User can click this button and [WarpSpeeder™] will proceed a testing for current frequency. If the testing is ok, then the current frequency will be saved into system registry. If the testing fail, system will do a fail-safe rebooting. After reboot, the [WarpSpeeder™] utility will restore to the hardware default setting or load the verified best and stable frequency according to the Recovery Dialog’s setting.

Note:

Because the testing programs, invoked in Auto-overclock and Verify, include DirectDraw, Direct3D and DirectShow tests, the DirectX 8.1 or newer runtime library is required. And please make sure your display card’s color depth is High color (16 bit) or True color (24/32 bit) that is required for Direct3D rendering.

5. Hardware Monitor Panel

Click the Hardware Monitor button in Main Panel, the button will be highlighted and the Hardware Monitor panel will slide out to left as the following figure.

In this panel, you can get the real-time status information of your system. The information will be refreshed every 1 second.



P4M800 Pro-M7

6. About Panel

Click the “about” button in Main Panel, the button will be highlighted and the About Panel will slide out to up as the following figure.

In this panel, you can get model name and detail information in hints of all the chipset that are related to overclocking. You can also get the mainboard’s BIOS model and the Version number of [WarpSpeeder™] utility.



P4M800 Pro-M7

Note:

Because the overclock, overvoltage, and hardware monitor features are controlled by several separate chipset, [WarpSpeeder™] divide these features to separate panels. If one chipset is not on board, the correlative button in Main panel will be disabled, but will not interfere other panels' functions. This property can make [WarpSpeeder™] utility more robust.