

ASUS[®]

V-Series P5G43

ASUS PC (Desktop Barebone)

Installation Manual

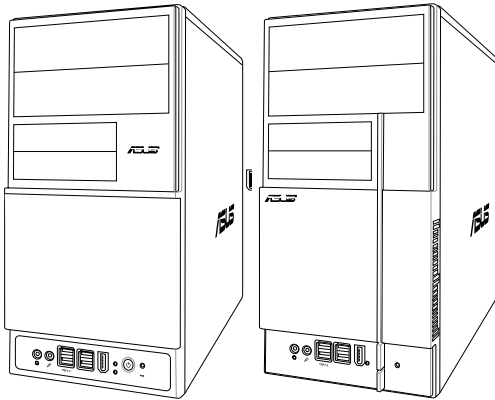

E4143

First Edition V1
November 2008

Copyright © 2008 ASUSTeK Computer INC. All Rights Reserved.

No part of this manual, including the products and software described in it, may be reproduced, transmitted, transcribed, stored in a retrieval system, or translated into any language in any form or by any means, except documentation kept by the purchaser for backup purposes, without the express written permission of ASUSTeK Computer INC. ("ASUS").

Product warranty or service will not be extended if: (1) the product is repaired, modified or altered, unless such repair, modification or alteration is authorized in writing by ASUS; or (2) the serial number of the product is defaced or missing.

ASUS PROVIDES THIS MANUAL "AS IS" WITHOUT WARRANTY OF ANY KIND, EITHER EXPRESS OR IMPLIED, INCLUDING BUT NOT LIMITED TO THE IMPLIED WARRANTIES OR CONDITIONS OF MERCHANTABILITY OR FITNESS FOR A PARTICULAR PURPOSE. IN NO EVENT SHALL ASUS, ITS DIRECTORS, OFFICERS, EMPLOYEES OR AGENTS BE LIABLE FOR ANY INDIRECT, SPECIAL, INCIDENTAL, OR CONSEQUENTIAL DAMAGES (INCLUDING DAMAGES FOR LOSS OF PROFITS, LOSS OF BUSINESS, LOSS OF USE OR DATA, INTERRUPTION OF BUSINESS AND THE LIKE), EVEN IF ASUS HAS BEEN ADVISED OF THE POSSIBILITY OF SUCH DAMAGES ARISING FROM ANY DEFECT OR ERROR IN THIS MANUAL OR PRODUCT.

SPECIFICATIONS AND INFORMATION CONTAINED IN THIS MANUAL ARE FURNISHED FOR INFORMATIONAL USE ONLY, AND ARE SUBJECT TO CHANGE AT ANY TIME WITHOUT NOTICE, AND SHOULD NOT BE CONSTRUED AS A COMMITMENT BY ASUS. ASUS ASSUMES NO RESPONSIBILITY OR LIABILITY FOR ANY ERRORS OR INACCURACIES THAT MAY APPEAR IN THIS MANUAL, INCLUDING THE PRODUCTS AND SOFTWARE DESCRIBED IN IT.

Products and corporate names appearing in this manual may or may not be registered trademarks or copyrights of their respective companies, and are used only for identification or explanation and to the owners' benefit, without intent to infringe.

Table of contents

Notices.....	vi
Safety information	vii
About this guide	viii
System package contents.....	x

Chapter 1: System introduction

1.1	Welcome!	1-2
1.2	Front panel	1-2
1.3	Rear panel.....	1-4
	Voltage selector.....	1-7
1.4	Internal components.....	1-8

Chapter 2: Basic installation

2.1	Preparation	2-2
2.2	Before you proceed	2-2
2.3	Removing the side cover and front panel assembly	2-3
2.4	Central Processing Unit (CPU)	2-4
	2.4.1 Overview	2-4
	2.4.2 Installing CPU	2-4
	2.4.3 Installing the CPU fan and heatsink assembly.....	2-6
2.5	Installing a DIMM.....	2-8
	2.5.1 Memory configurations.....	2-9
	2.5.2 Installing a DDR2 DIMM	2-15
	2.5.3 Removing a DDR2 DIMM	2-15
2.6	Expansion slots.....	2-16
	2.6.1 Installing an expansion card	2-16
	2.6.2 Configuring an expansion card	2-16
	2.6.3 PCI slots.....	2-18
	2.6.4 PCI Express x1 slot.....	2-18
	2.6.5 PCI Express x16 slot.....	2-18
2.7	Installing an optical drive	2-19
2.8	Installing a hard disk drive.....	2-20
2.9	Installing the card reader	2-22
2.10	Installing a floppy disk drive.....	2-24
2.11	Re-connecting cables.....	2-25
	LED cables.....	2-25

Table of contents

2.12	Reinstalling the cover	-2-26
------	------------------------------	-------

Chapter 3: Starting up

3.1	Installing an operating system	3-2
3.2	Powering up.....	3-2
3.3	Support DVD information	3-2
3.3.1	Running the support DVD	3-3
3.3.2	Utilities menu	3-4
3.3.3	Manual menu	3-6
3.3.4	ASUS Contact information	3-7
3.3.5	Other information	3-8
3.4	Software information	3-10
	ASUS PC Probe II.....	3-10

Chapter 4: Motherboard information

4.1	Introduction	4-2
4.2	Motherboard layout.....	4-2
4.3	Jumpers	4-3
4.3	Connectors	4-5

Chapter 5: BIOS setup

5.1	Managing and updating your BIOS	5-2
5.1.1	ASUS Update utility	5-2
5.1.2	Creating a bootable floppy disk.....	5-5
5.1.3	ASUS EZ Flash 2 utility.....	5-6
5.1.4	AFUDOS utility	5-7
5.1.5	ASUS CrashFree BIOS 3 utility	5-9
5.2	BIOS setup program	5-10
5.2.1	BIOS menu screen.....	5-11
5.2.2	Menu bar.....	5-11
5.2.3	Navigation keys.....	5-11
5.2.4	Menu items	5-12
5.2.5	Sub-menu items.....	5-12
5.2.6	Configuration fields	5-12
5.2.7	Pop-up window	5-12
5.2.8	Scroll bar.....	5-12

Table of contents

5.2.9	General help	5-12
5.3	Main menu	5-13
5.3.1	System Time	5-13
5.3.2	System Date	5-13
5.3.3	Legacy Diskette A	5-13
5.3.4	SATA 1~6	5-14
5.3.5	Storage Configuration	5-15
5.3.6	System Information	5-16
5.4	Advanced menu	5-17
5.4.1	Jumperfree Configuration	5-17
5.4.2	CPU Configuration	5-19
5.4.3	Chipset	5-21
5.4.4	Onboard Devices Configuration	5-23
5.4.5	USB Configuration	5-25
5.4.6	PCI PnP	5-26
5.5	Power menu	5-27
5.5.1	Suspend Mode	5-27
5.5.2	ACPI 2.0 Support	5-27
5.5.3	ACPI APIC Support	5-27
5.5.4	APM Configuration	5-28
5.5.5	Hardware Monitor	5-29
5.6	Boot menu	5-30
5.6.1	Boot Device Priority	5-30
5.6.2	Boot Settings Configuration	5-31
5.6.3	Security	5-32
5.7	Tools menu	5-34
5.7.1	ASUS EZ Flash 2	5-34
5.7.2	Express Gate	5-35
5.7.3	AI NET 2	5-36
5.8	Exit menu	5-37

Notices

Federal Communications Commission Statement

This device complies with Part 15 of the FCC Rules. Operation is subject to the following two conditions:

- This device may not cause harmful interference, and
- This device must accept any interference received including interference that may cause undesired operation.

This equipment has been tested and found to comply with the limits for a Class B digital device, pursuant to Part 15 of the FCC Rules. These limits are designed to provide reasonable protection against harmful interference in a residential installation. This equipment generates, uses and can radiate radio frequency energy and, if not installed and used in accordance with manufacturer's instructions, may cause harmful interference to radio communications. However, there is no guarantee that interference will not occur in a particular installation. If this equipment does cause harmful interference to radio or television reception, which can be determined by turning the equipment off and on, the user is encouraged to try to correct the interference by one or more of the following measures:

- Reorient or relocate the receiving antenna.
- Increase the separation between the equipment and receiver.
- Connect the equipment to an outlet on a circuit different from that to which the receiver is connected.
- Consult the dealer or an experienced radio/TV technician for help.



WARNING! The use of shielded cables for connection of the monitor to the graphics card is required to assure compliance with FCC regulations. Changes or modifications to this unit not expressly approved by the party responsible for compliance could void the user's authority to operate this equipment.

Canadian Department of Communications Statement

This digital apparatus does not exceed the Class B limits for radio noise emissions from digital apparatus set out in the Radio Interference Regulations of the Canadian Department of Communications.

This class B digital apparatus complies with Canadian ICES-003.

Safety information

Electrical safety

- To prevent electrical shock hazard, disconnect the power cable from the electrical outlet before relocating the system.
- When adding or removing devices to or from the system, ensure that the power cables for the devices are unplugged before the signal cables are connected.
- If the power supply is broken, do not try to fix it by yourself. Contact a qualified service technician or your retailer.

Operation safety

- Before installing devices into the system, carefully read all the documentation that came with the package.
- Before using the product, make sure all cables are correctly connected and the power cables are not damaged. If you detect any damage, contact your dealer immediately.
- To avoid short circuits, keep paper clips, screws, and staples away from connectors, slots, sockets and circuitry.
- Avoid dust, humidity, and temperature extremes. Do not place the product in any area where it may become wet. Place the product on a stable surface.
- If you encounter technical problems with the product, contact a qualified service technician or your retailer.

Lithium-Ion Battery Warning

CAUTION: Danger of explosion if battery is incorrectly replaced. Replace only with the same or equivalent type recommended by the manufacturer. Dispose of used batteries according to the manufacturer's instructions.

VORSICHT: Explosionsgefahr bei unsachgemäßen Austausch der Batterie. Ersatz nur durch denselben oder einem vom Hersteller empfohlenem ähnlichen Typ. Entsorgung gebrauchter Batterien nach Angaben des Herstellers.

LASER PRODUCT WARNING

CLASS 1 LASER PRODUCT

About this guide

Audience

This guide provides general information and installation instructions about the ASUS Vintage V-Series P5G43 barebone system. This guide is intended for experienced users and integrators with hardware knowledge of personal computers.

How this guide is organized

This guide contains the following parts:

1. Chapter 1: System introduction

This chapter gives a general description of the ASUS V-Series P5G43. The chapter lists the system features, including introduction on the front and rear panel, and internal components.

2. Chapter 2: Basic installation

This chapter provides step-by-step instructions on how to install components in the system.

3. Chapter 3: Starting up

This chapter helps you power up the system and install drivers and utilities from the support DVD.

4. Chapter 4: Motherboard information

This chapter gives information about the motherboard that comes with the system. This chapter includes the motherboard layout, jumper settings, and connector locations.

5. Chapter 5: BIOS setup

This chapter tells you how to change system settings through the BIOS Setup menus and describes the BIOS parameters.

Conventions used in this guide



WARNING: Information to prevent injury to yourself when trying to complete a task.



CAUTION: Information to prevent damage to the components when trying to complete a task.



IMPORTANT: Instructions that you **MUST** follow to complete a task.



NOTE: Tips and additional information to aid in completing a task.

Where to find more information

Refer to the following sources for additional information and for product and software updates.

1. **ASUS Websites**

The ASUS websites worldwide provide updated information on ASUS hardware and software products. Refer to the ASUS contact information.

2. **Optional Documentation**

Your product package may include optional documentation, such as warranty flyers, that may have been added by your dealer. These documents are not part of the standard package.

System package contents

Check your V-Series P5G43 system package for the following items.



If any of the items is damaged or missing, contact your retailer immediately.

Item description	
1.	ASUS V-Series P5G43 barebone system with <ul style="list-style-type: none">• ASUS motherboard• Power supply unit• ASUS chassis
2.	Cable <ul style="list-style-type: none">• AC power cable
3.	Support DVD
4.	User guide
5.	Telecom Adapter Card (Optional)

Chapter 1

This chapter gives you a general description of the ASUS V-Series P5G43. The chapter lists the system features including introduction on the front and rear panel, and internal components.

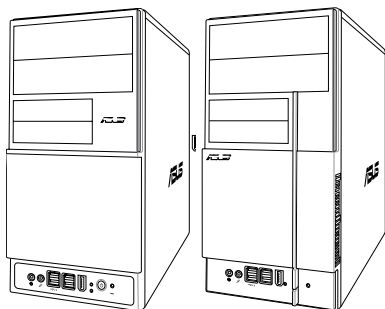

System introduction

1.1 Welcome!

Thank you for buying the ASUS V-Series P5G43!

The ASUS V-Series P5G43 is an all-in-one barebone system with a versatile home entertainment feature.

The system comes in a stylish casing and powered by the ASUS motherboard that supports the Intel® Core™2 Extreme / Core™2 Duo / Core™2 Quad / Pentium® D / Pentium® 4 / Celeron® D processors in the 775-land package.

The system supports up to 8 GB of system memory using DDR2-1066/800/667 DIMMs. High-resolution graphics via integrated graphics controller or PCI Express x16 slot, Serial ATA, USB 2.0, and 8-channel audio feature the system and take you ahead in the world of power computing.

1.2 Front panel

The front panel includes the optical drive bays, floppy disk drive slot, power button, and several I/O ports are located at the front panel.

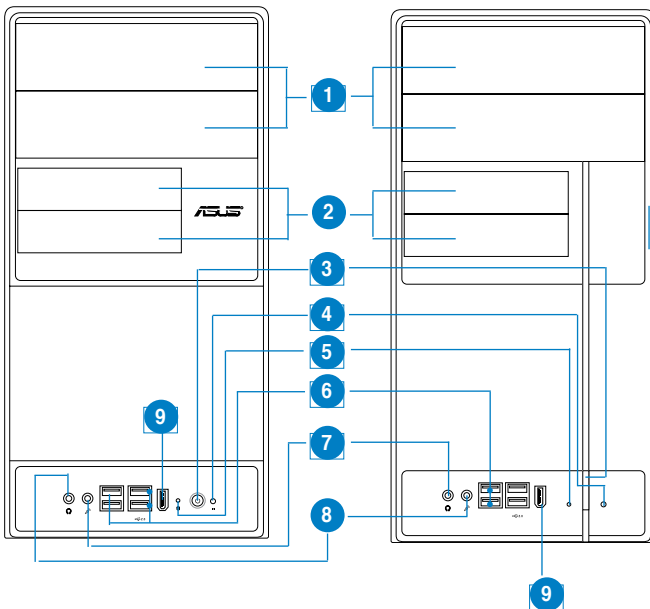

1. Two empty 5.25-inch bays. These bays are for IDE optical drives.
2. 3.5-inch drive bays. These slots are for 3.5-inch floppy or hard disk drives.
3. Power button. Press this button to turn the system on.
4. Reset button. Press this button to reboot the system without turning off the power.
5. HDD LED. This LED lights up when data is read from or written to the hard disk drive.
6. USB 2.0 ports. These Universal Serial Bus 2.0 (USB 2.0) ports are available for connecting USB 2.0 devices such as a mouse, printer, scanner, camera, PDA, and others.
7. Headphone port. This Line In (green) port connects a headphone with a stereo mini-plug.
8. Microphone port. This Mic (pink) port connects a microphone.
9. IEEE1394 port.



This V-series provide V2/V3 two types of front panel for users to choose, please refer to your product package for the front panel type you purchased.

1.3 Rear panel

The system rear panel includes the power connector and several I/O ports that allow convenient connection of devices.

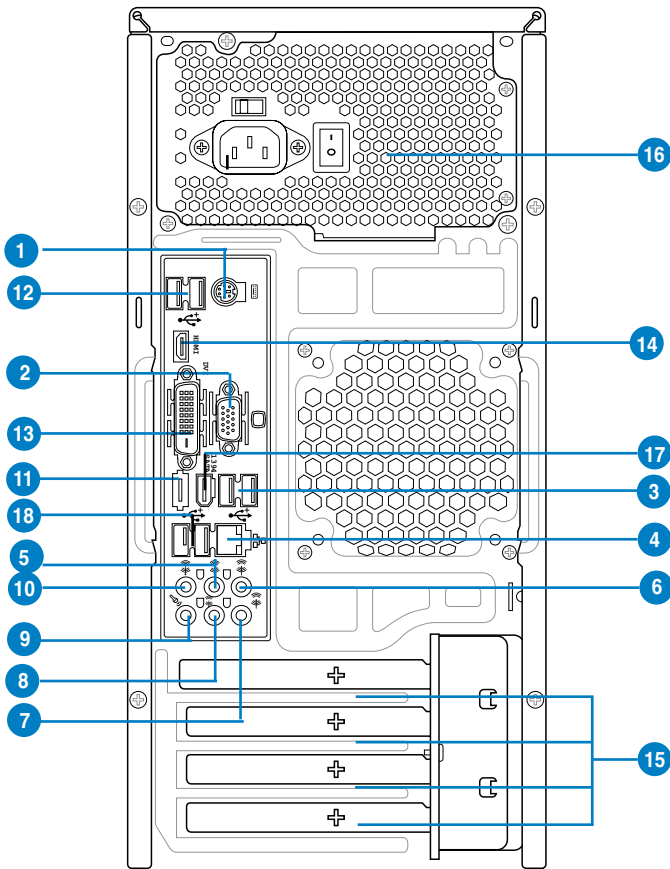

1. **PS/2 keyboard port (purple).** This port is for a PS/2 keyboard.
2. **VGA port.** This port is for a VGA monitor or other VGA-compatible devices.
3. **USB 2.0 ports.** These two 4-pin Universal Serial Bus (USB) ports are available for connecting USB 2.0 devices.
4. **LAN (RJ-45) port.** Supported by Gigabit LAN controller, this port allows Gigabit connection to a Local Area Network (LAN) through a network hub. Refer to the table below for the LAN port LED indications.

LAN port LED indications

Activity LED		Link Speed LED	
Status	Description	Status	Description
OFF	No link	OFF	10 Mbps connection
ORANGE	Linked	ORANGE	100 Mbps connection
BLINKING	Data activity	GREEN	1 Gbps connection

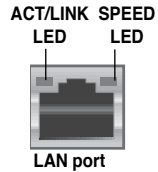

- Rear Speaker Out port (black).** This port connects the rear speakers in a 4-channel, 6-channel, or 8-channel audio configuration.
- Center/Subwoofer port (orange).** This port connects the center/subwoofer speakers.
- Line In port (light blue).** This port connects the tape, CD, DVD player, or other audio sources.
- Line Out port (lime).** This port connects a headphone or a speaker. In 4-channel, 6-channel, and 8-channel configuration, the function of this port becomes Front Speaker Out.
- Microphone port (pink).** This port connects a microphone.
- Side Speaker Out port (gray).** This port connects the side speakers in an 8-channel audio configuration.



Refer to the audio configuration table below for the function of the audio ports in 2, 4, 6, or 8-channel configuration.

Audio 2, 4, 6, or 8-channel configuration

Port	Headset 2-channel	4-channel	6-channel	8-channel
Light Blue	Line In	Line In	Line In	Line In
Lime	Line Out	Front Speaker Out	Front Speaker Out	Front Speaker Out
Pink	Mic In	Mic In	Mic In	Mic In
Orange	–	–	Center/Subwoofer	Center/Subwoofer
Black	–	Rear Speaker Out	Rear Speaker Ou	Rear Speaker Out
Gray	–	–	–	Side Speaker Out

- External SATA port.** This port connects to an external Serial ATA hard disk drive.



DO NOT insert different connectors to the external SATA port.

- USB 2.0 ports.** These two 4-pin Universal Serial Bus (USB) ports are available for connecting USB 2.0 devices.
- DVI port.** This port is for any DVI-D compatible device. DVI-D can't be converted to output RGB Signal to CRT and isn't compatible with DVI-I.

14. **HDMI port.** This port is for a High-Definition Multimedia Interface (HDMI) connector, and is HDCP compliant allowing playback of HD DVD, Blu-Ray and other protected content.
15. **Expansion slot covers.** Remove these covers when installing expansion cards.
16. **Power supply unit fan vent.** This vent is for the PSU fan that provides ventilation inside the power supply unit.
17. **IEEE1394a port.** This 6-pin IEEE 1394a port provides high-speed connectivity for audio/video devices, storage peripherals, PCs, or portable devices.
18. **USB 2.0 ports.** These two 4-pin Universal Serial Bus (USB) ports are available for connecting USB 2.0 devices.

Voltage selector

The PSU has a 115 V/230 V voltage selector switch located beside the power connector. Use this switch to select the appropriate system input voltage according to the voltage supply in your area.

If the voltage supply in your area is 100-127 V, set this switch to 115 V.

If the voltage supply in your area is 200-240 V, set this switch to 230 V.

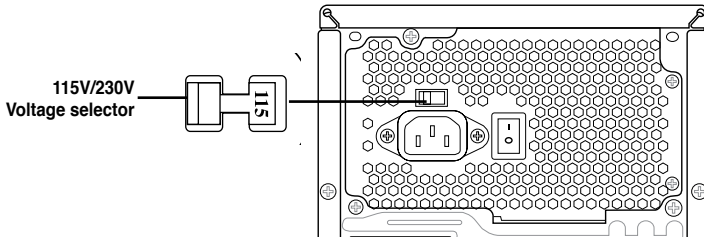

Setting the switch to 115V in a 230V environment or 230V in a 115V environment will seriously damage the system!

1.4 Internal components

The illustration below is the internal view of the system when you remove the top cover and the power supply unit. The installed components are labeled for your reference. Proceed to Chapter 2 for instructions on installing additional system components.

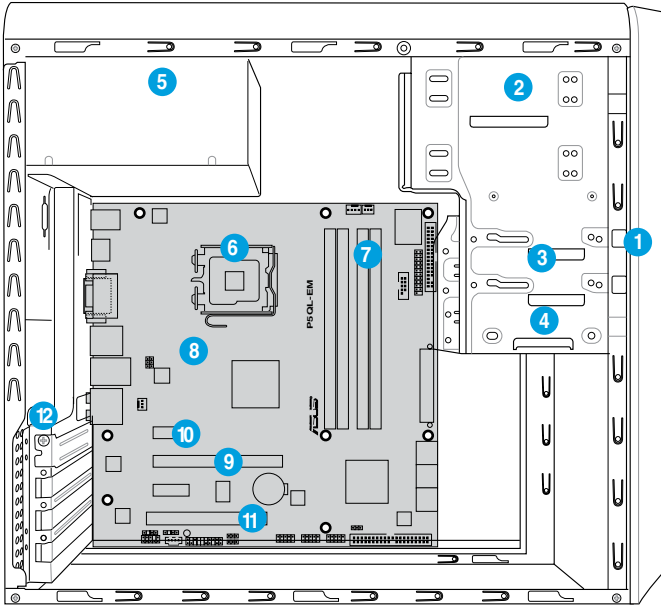

- | | |
|---------------------------------|-------------------------|
| 1. Front panel cover | 8. ASUS motherboard |
| 2. 5.25-inch optical drive bays | 9. PCI Express x16 slot |
| 3. Floppy disk drive bay | 10. PCI Express x1 slot |
| 4. Hard disk drive bay | 11. PCI slot |
| 5. Power supply unit | 12. Metal bracket lock |
| 6. CPU socket | |
| 7. DIMM sockets | |

Chapter 2

This chapter provides step-by-step instructions on how to install components in the system.

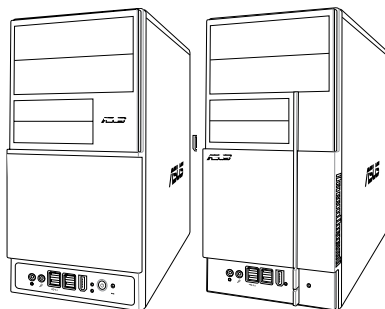

Basic installation

2.1 Preparation

Before you proceed, make sure that you have all the components you plan to install in the system.

Basic components to install

1. Central Processing Unit (CPU)
2. DDR2 Dual Inline Memory Module (DIMM)
3. Expansion card(s)
4. Hard disk drive
5. Optical drive
6. Floppy disk drive

Tool

Phillips (cross) screw driver

2.2 Before you proceed

Take note of the following precautions before you install components into the system.



- Use a grounded wrist strap or touch a safely grounded object or a metal object, such as the power supply case, before handling components to avoid damaging them due to static electricity.
- Hold components by the edges to avoid touching the ICs on them.
- Whenever you uninstall any component, place it on a grounded antistatic pad or in the bag that came with the component.

The motherboard comes with an onboard standby power LED. This LED lights up to indicate that the system is ON, in sleep mode or in soft-off mode, and not powered OFF. Unplug the power cable from the power outlet and make sure that the standby power LED is OFF before installing any system component.

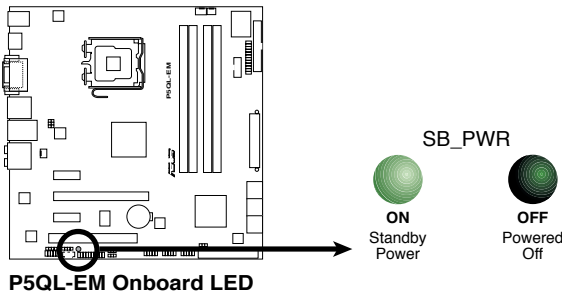

2.3 Removing the side cover and front panel assembly

1. Remove the cover screws on the rear panel.
2. Pull the side cover toward the rear panel until its hooks disengage from the chassis tab holes. Set the side cover aside.
3. Locate the front panel assembly hooks, then lift them until they disengage from the chassis.
4. Swing the front panel assembly to the right, until the hinge-like tabs on the right side of the assembly are exposed.
5. Remove the front panel assembly, then set aside.

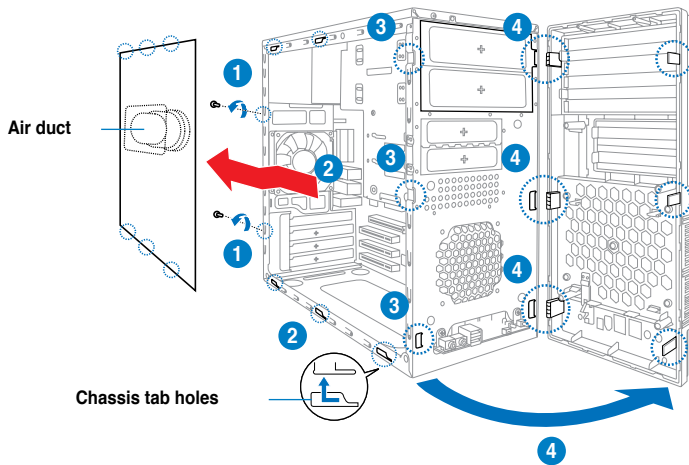

2.4 Central Processing Unit (CPU)

2.4.1 Overview

The motherboard comes with a surface mount LGA775 socket designed for the Intel® Core™2 Quad / Intel® Core™2 Extreme / Core™2 Duo / Pentium® Extreme / Pentium® D/ Pentium® 4 / Celeron® processors.



- Make sure that all power cables are unplugged before installing the CPU.
- Connect the chassis fan cable to the CHA_FAN1 connector to ensure system stability.



- Upon purchase of the motherboard, make sure that the PnP cap is on the socket and the socket contacts are not bent. Contact your retailer immediately if the PnP cap is missing, or if you see any damage to the PnP cap/socket contacts/motherboard components. ASUS will shoulder the cost of repair only if the damage is shipment/transit-related.
- Keep the cap after installing the motherboard. ASUS will process Return Merchandise Authorization (RMA) requests only if the motherboard comes with the cap on the LGA775 socket.
- The product warranty does not cover damage to the socket contacts resulting from incorrect CPU installation/removal, or misplacement/loss/incorrect removal of the PnP cap.

2.4.2 Installing CPU

To install a CPU:

1. Locate the CPU socket on the motherboard.



Before installing the CPU, make sure that the socket box is facing towards you and the load lever is on your left.

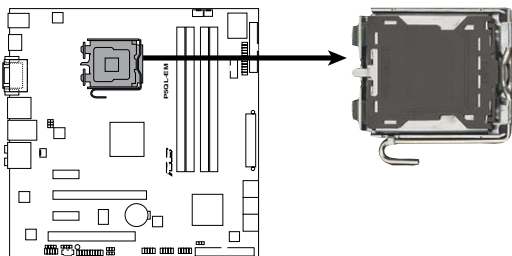

P5QL-EM CPU Socket 775

2. Press the load lever with your thumb (A), then move it to the left (B) until it is released from the retention tab.

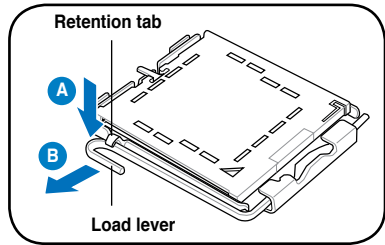

To prevent damage to the socket pins, do not remove the PnP cap unless you are installing a CPU.

3. Lift the load lever in the direction of the arrow to a 135° angle.
4. Lift the load plate with your thumb and forefinger to a 100° angle (4A), then push the PnP cap from the load plate window to remove (4B).

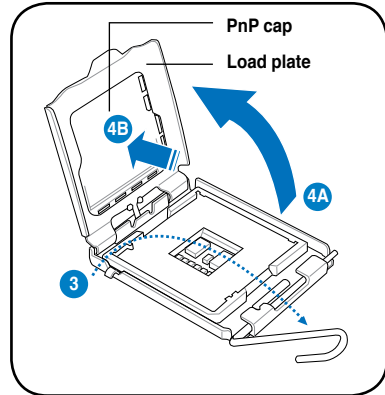

5. Position the CPU over the socket, making sure that the gold triangle is on the bottom-left corner of the socket then fit the socket alignment key into the CPU notch.

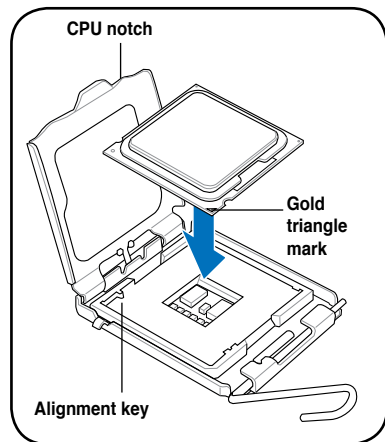

6. Apply Thermal Interface Material on the CPU before closing the load plate.



DO NOT eat the Thermal Interface Material. If it gets into your eyes or touches your skin, make sure to wash it off immediately, and seek professional medical help.

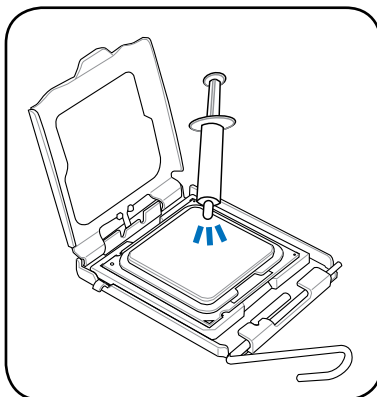

7. Close the load plate (A), then push the load lever (B) until it snaps into the retention tab.

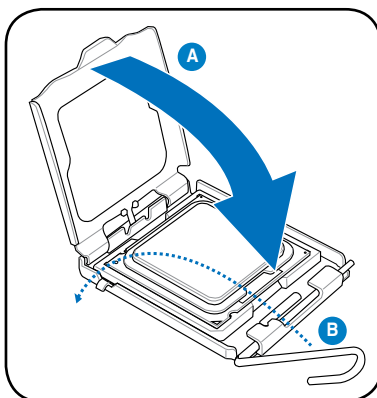

2.4.3 Installing the CPU fan and heatsink assembly

The Intel® Pentium® 4 LGA775 processor requires a specially designed heatsink and fan assembly to ensure optimum thermal condition and performance.



- When you buy a boxed Intel® Pentium® 4 processor, the package includes the CPU fan and heatsink assembly. If you buy a CPU separately, make sure that you use only Intel®-certified multi-directional heatsink and fan.
- Your Intel® Pentium® 4 LGA775 heatsink and fan assembly comes in a push-pin design and requires no tool to install.



If you purchased a separate CPU heatsink and fan assembly, make sure that the Thermal Interface Material is properly applied to the CPU heatsink or CPU before you install the heatsink and fan assembly.

To install the CPU heatsink and fan:

1. Place the heatsink on top of the installed CPU, making sure that the four fasteners match the holes on the motherboard.
2. Push down two fasteners at a time in a diagonal sequence to secure the heatsink and fan assembly in place.

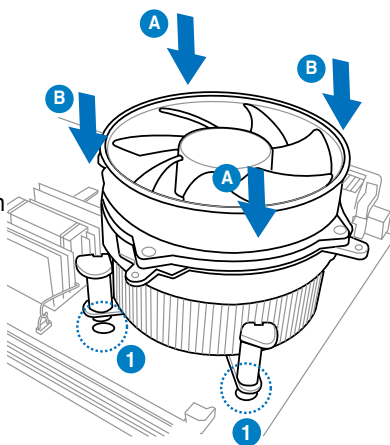
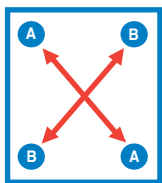

3. When the fan and heatsink assembly is in place, connect the CPU fan cable to the connector on the motherboard.

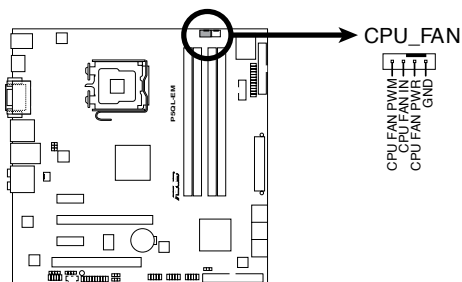

P5QL-EM CPU Fan Connector



Do not forget to connect the CPU fan connector! Hardware monitoring errors can occur if you fail to plug this connector.

2.5 Installing a DIMM

The motherboard comes with four Double Data Rate 2 (DDR2) Dual Inline Memory Modules (DIMM) sockets.

The figure illustrates the location of the DDR2 DIMM sockets:

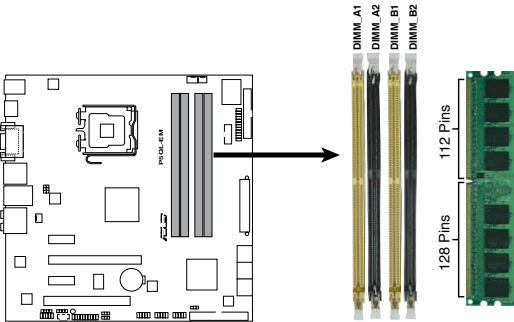

P5QL-EM 240-pin DDR2 DIMM Sockets

Channel	Sockets
Channel A	DIMM_A1 and DIMM_A2
Channel B	DIMM_B1 and DIMM_B2



- This chipset officially supports DDR2-800 MHz. With the ASUS Super Memspeed Technology, this motherboard natively supports up to DDR2-1066 MHz. See the table below.

FSB	DDR2
1333	1066*
1333	800
1333	667
1066	1066*
1066	800
1066	667

- *If you install a DDR2-1066 memory module whose SPD is DDR2-800, make sure that you set the **DRAM Frequency** item in BIOS to [DDR2-1066MHz]. See section 5.4.1 Jumperfree Configuration for details.

2.5.1 Memory configurations

You may install 256 MB, 512 MB, 1 GB, and 2 GB unbuffered non-ECC DDR2 DIMMs into the DIMM sockets.

Recommended Memory Configurations

Mode	DIMM_A1	DIMM_A2	DIMM_B1	DIMM_B2
One DIMM	DS/SS	-	-	-
	-	DS/SS	-	-
	-	-	DS/SS	-
	-	-	-	DS/SS
Two DIMMs	DS/SS	-	DS/SS	-
	DS/SS	-	-	DS/SS
	-	DS/SS	DS/SS	-
	-	DS/SS	-	DS/SS
Three DIMMs	SS	SS	DS/SS	-
	SS	SS	-	DS/SS
	DS/SS	-	SS	SS
	-	DS/SS	SS	SS
Four DIMMs	SS	SS	SS	SS



- You may install varying memory sizes in Channel A and Channel B. The system maps the total size of the lower-sized channel for the dual-channel configuration. Any excess memory from the higher-sized channel is then mapped for single-channel operation.
- Always install DIMMs with the same CAS latency. For optimum compatibility, we recommend that you obtain memory modules from the same vendor.
- Due to the memory address limitation on 32-bit Windows OS, when you install 4GB or more memory on the motherboard, the actual usable memory for the OS can be about 3GB or less. For effective use of memory, we recommend that you install a 64-bit Windows OS when having 4GB or more memory installed on the motherboard.



Notes on memory limitations

- Due to chipset limitation, this motherboard can only support up to 8 GB on the operating systems listed below. You may install a maximum of 2 GB DIMMs on each slot.

64-bit
Windows® XP Professional x64 Edition
Windows® Vista x64 Edition

- Some old-version DDR2-800/667 DIMMs may not match Intel®'s On-Die-Termination (ODT) requirement and will automatically downgrade to run at DDR2-533. If this happens, contact your memory vendor to check the ODT value.
- Due to chipset limitation, DDR2-800 with CL=4 will be downgraded to run at DDR2-667 by default setting. If you want to operate with lower latency, adjust the memory timing manually.
- Due to chipset limitation, DDR2-667 with CL=3 will be downgraded to run at DDR2-533 by default setting. If you want to operate with lower latency, adjust the memory timing manually.

P5QL-EM Motherboard Qualified Vendors Lists (QVL) DDR2-1066 MHz capability

Size	Vendor	Part No.	CL	Chip Brand	SS/ DS	Chip No.	DIMM Support	
							A*	B*
512MB	Kingston	KHX8500D2/512	N/A	Kingston	SS	Heat-Sink Package	•	•
512MB	Kingston	KVR1066D2N7/512	N/A	Elpida	SS	E5108AJBG-1J-E	•	•
512MB	Kingston	KHX8500D2K2/1GN	N/A	Kingston	SS	Heat-Sink Package	•	•
1G	Kingston	KVR1066D2N7/1G	N/A	Elpida	DS	E5108AJBG-1J-E	•	
1G	Kingston	KHX8500D2/1G	N/A	Kingston	DS	Heat-Sink Package	•	•
1G	Qimonda	HYS64T128020EU-19F-C	6	Qimonda	DS	HYB18T512800CF19FF SS24313	•	•
1G	Kingmax	KLED48F-A8K15	N/A	Kingmax	DS	KKA8FFIXF-JFS-18A	•	•
1G	Corsair	CM2X1024-8500C5	N/A	Corsair	DS	Heat-Sink Package	•	•
1G	GEIL	GB24GB8500C5QC	5	GEIL	SS	GL2L128M88BA25AB	•	•
1G	GEIL	GE22GB1066C5DC	5	GEIL	DS	Heat-Sink Package	•	
4G(kit of 2)	GEIL	GX24GB8500C5UDC	5	N/A	DS	Heat-Sink Package	•	•
2G(kit of 2)	G.SKILL	F2-8500CL5D-2GBPK	5-5-5-15	N/A	DS	Heat-Sink Package	•	•
4G(kit of 2)	G.SKILL	F2-8500CL5D-4GBPK	5-5-5-15	N/A	DS	Heat-Sink Package	•	
1G	G.SKILL	F2-8500CL5S-1GBPK	5-5-5-15	G.SKILL	DS	Heat-Sink Package	•	•

DDR2 800 Qualified Vendors List

Size	Vendor	Part No.	CL	Chip Brand	SS/ DS	Chip No.	DIMM support		
							A*	B*	C*
1G	Kingston	KHX6400D2LL/1G	N/A	Kingston	DS	Heat-Sink Package	•	•	
512MB	Kingston	KHX6400D2LLK2/1GN	N/A	Kingston	SS	Heat-Sink Package	•	•	•
512MB	Kingston	KVR800D2N5/512	N/A	Promos	SS	V59C1512804QCF25SY032406PECPA	•	•	•
1G(Kit of 2)	Kingston	KHX6400D2K2/2G	N/A	Kingston	DS	Heat-Sink Package	•	•	
512MB	Kingston	KVR800D2N6/512	N/A	Elpida	SS	E5108AJBG-8E-E	•	•	•
1G	Kingston	KVR800D2N6/1G	N/A	Elpida	DS	E5108AJBG-8E-E	•	•	
2G	Kingston	KVR800D2N5/2G	N/A	Elpida	DS	E1108ACBG-8E-E	•	•	
2G	Kingston	KHX6400D2/2G	N/A	Kingston	DS	Heat-Sink Package	•	•	
4G	Kingston	KVR800D2N6/4G	N/A	Elpida	DS	E2108ABSE-8G-E	•	•	
512MB	Samsung	M378T6553GZS-CF7	6	Samsung	SS	K4T51083QG-HCF7	•	•	•
1G	Samsung	M378T2863QZS-CF7	6	Samsung	SS	K4T1G084QQ-HCF7	•	•	•
1G	Samsung	M378T2953GZ3-CF7	6	Samsung	DS	K4T51083QG-HCF7	•	•	
2G	Samsung	M378T5663QZ3-CF7	6	Samsung	DS	K4T1G084QQ-HCF7	•	•	
4G	Samsung	M378T5263AZ3-CF7	N/A	Samsung	DS	K4T2G084QA-HCF7	•	•	
512MB	Qimonda	HYS64T64000EU-2.5-B2	6	Qimonda	SS	HYB18T512800B2F25FSS28380	•	•	•
1G	Qimonda	HYS64T128020EU-2.5-B2	6	Qimonda	DS	HYB18T512800B2F25FSS28380	•	•	
1G	Corsair	XMS2-6400	4	Corsair	DS	Heat-Sink Package	•	•	
1G	Corsair	XMS2-6400	5	Corsair	DS	Heat-Sink Package	•	•	
2G(Kit of 2)	Corsair	CM2X2048-6400C5DHX	5	Corsair	DS	Heat-Sink Package	•	•	
2G(Kit of 2)	Corsair	CM2X2048-6400C5	5	Corsair	DS	Heat-Sink Package	•	•	
512MB	HY	HYMP564U64CP8-S5 AB	5	Hynix	SS	HY5PS12821CFP-S5	•	•	•
1G	HY	HYMP512U64CP8-S5 AB	5	Hynix	DS	HY5PS12821CFPS5	•	•	
512MB	Kingmax	KLDC28F-A8K15	N/A	Kingmax	SS	KKA8FF1XF-JFS-25A	•	•	•
1G	Kingmax	KLDD48F-A8K15	N/A	Kingmax	DS	KKA8FF1XF-HFS-25A	•	•	
2G	G.SKILL	F2-6400CL5D-4GBPQ	5	G.SKILL	DS	Heat-Sink Package	•	•	
2G	G.SKILL	F2-6400CL4D-4GBPK	4	G.SKILL	DS	Heat-Sink Package	•	•	
512MB(Kit of 2)	G.SKILL	F2-6400CL5D-1GBNQ	5-5-5-15	G.SKILL	SS	Heat-Sink Package	•	•	•
1G	OCZ	OCZ2RPR8002GK	4	OCZ	DS	Heat-Sink Package	•	•	
1G	OCZ	OCZ2G800R22GK	5	OCZ	DS	Heat-Sink Package	•	•	
1G	OCZ	OCZ2P800R22GK	4	OCZ	DS	Heat-Sink Package	•	•	
1G	OCZ	OCZ2VU8004GK	6	OCZ	DS	Heat-Sink Package	•	•	
2G	OCZ	OCZ2P8004GK	5	OCZ	DS	Heat-Sink Package	•	•	
1G	Elixir	M2Y1G64TU8HB0B-25C	5	Elixir	DS	N2TU51280BE-25C802006Z1DV	•	•	

(continued on the next page)

Size	Vendor	Part No.	CL	Chip Brand	SS/DS	Chip No.	DIMM -support		
							A*	B*	C*
512MB	Apacer	78.91G91.9K5	5	Apacer	SS	AM4B570B.JQJS8E0751C	*	*	*
1G	Apacer	78.01GA0.9K5	5	Apacer	SS	AM4B5808CQJS8E0749D	*	*	*
2G	Apacer	78.A1GA0.9K4	5	Apacer	DS	AM4B5808CQJS8E0740E	*	*	
2G	Apacer	78.A1GA0.9K4	5	Apacer	DS	AM4B5808CQJS8E0747D	*	*	
1G	ADATA	AD2800E001GU	444-12	N/A	SS	Heat-Sink Package	*	*	*
1G	Transcend	TS128MLQ64V8J	5	Mircon	DS	7HD22D9GMH	*	*	
512MB	Transcend	TS64MLQ64V8J512MB	5	Micron	SS	7HD22 D9GMH	*	*	*
1G	Transcend	TS128MLQ64V8J	5	Transcend	DS	TQ123PJF8F0801	*	*	
512MB	ADATA	M2OAD6G3H3160Q1E58	N/A	ADATA	SS	AD29608A8A-25EG80812	*	*	*
512MB	VDATA	M2GVD6G3H3160Q1E52	N/A	VDATA	SS	VD29608A8A-25EG20813	*	*	*
1G	ADATA	M2OAD6G314170Q1E58	N/A	ADATA	DS	AD29608A8A-25EG80810	*	*	
1G	VDATA	M2GVD6G314170Q1E58	N/A	VDATA	DS	VD29608A8A-25EG80813	*	*	
1G	PSC	AL7E8F73C-8E1	5	PSC	SS	A3R1GE3CFF734MAA0E	*	*	*
2G	PSC	AL8E8F73C-8E1	5	PSC	DS	A3R1GE3CFF734MAA0E	*	*	
1G	GEIL	GB22GB6400C4DC	4	GEIL	DS	GL2L64M088BA30EB	*	*	
1G	GEIL	GB24GB6400C4QC	4	GEIL	DS	GL2L64M088BA30EB	*	*	
1G	GEIL	GB22GB6400C5DC	5	GEIL	DS	GL2L64M088BA30EB	*	*	
1G	GEIL	GB24GB6400C5QC	5	GEIL	DS	GL2L64M088BA30EB	*	*	
1G	GEIL	GX22GB6400DC	5	GEIL	DS	Heat-Sink Package	*	*	
1G	GEIL	GE22GB800C4DC	4	GEIL	DS	Heat-Sink Package	*	*	
1G	GEIL	GE24GB800C4QC	4	GEIL	DS	Heat-Sink Package	*	*	
1G	GEIL	GX22GB6400UDC	4	GEIL	DS	Heat-Sink Package	*	*	
1G	GEIL	GE22GB800C5DC	5	GEIL	DS	Heat-Sink Package	*	*	
1G	GEIL	GE24GB800C5QC	5	GEIL	DS	Heat-Sink Package	*	*	
2G	GEIL	GB24GB6400C4DC	4	GEIL	DS	GL2L128M88BA25AB	*	*	
2G	GEIL	GB24GB6400C5DC	5	GEIL	DS	GL2L128M88BA25AB	*	*	
2G	GEIL	GB28GB6400C5QC	5	GEIL	DS	GL2L128M88BA25AB	*	*	
2G	GEIL	GB28GB6400C4QC	4	GEIL	DS	GL2L128M88BA25AB	*	*	
2G	GEIL	GX22GB6400LX	5	GEIL	DS	Heat-Sink Package	*	*	
2G	GEIL	GX24GB6400DC	5	GEIL	DS	Heat-Sink Package	*	*	
2G	GEIL	GE28GB800C5QC	5	GEIL	DS	Heat-Sink Package	*	*	
2G	GEIL	GE28GB800C4QC	4	GEIL	DS	Heat-Sink Package	*	*	
2G	GEIL	GX22GB6400CUSC	4	GEIL	DS	Heat-Sink Package	*	*	
2G	GEIL	GE24GB800C4DC	4	GEIL	DS	Heat-Sink Package	*	*	
2G	GEIL	GE24GB800C5DC	5	GEIL	DS	Heat-Sink Package	*	*	
1G	Super Talent	T800UB1GC4	4	Super Talent	DS	Heat-Sink Package	*	*	
1G	G.SKILL	F2-6400CL5D-2GBNQ	5	G.SKILL	DS	Heat-Sink Package	*	*	
1G	G.SKILL	F2-6400CL4D-2GBPK	4	G.SKILL	DS	Heat-Sink Package	*	*	
1G	G.SKILL	F2-6400CL4D-2GBHK	4	G.SKILL	DS	Heat-Sink Package	*	*	

DDR2-667MHz capability

Size	Vendor	Part No.	CL	Chip Brand	SS/DS	Chip No.	DIMM support		
							A*	B*	C*
512MB	Kingston	KVR667D2N5/512	N/A	Hynix	SS	HY5PS12821EFP-Y5	.	.	.
1G	Kingston	KVR667D2N5/1G	N/A	Hynix	DS	HY5PS12821EFP-Y5	.	.	.
2G	Kingston	KVR667D2N5/2G	N/A	Micron	DS	7RE22 D9HNL	.	.	.
512MB	Qimonda	HYS64T6400EU-3S-B2	5	Qimonda	SS	HYB18T512B00B2F3SFSS28171	.	.	.
1G	Qimonda	HYS64T128020EU-3S-B2	5	Qimonda	DS	HYB18T512B00B2F3SFSS28171	.	.	.
1G	Corsair	VS1GB667D2	N/A	Corsair	DS	MID095D62864M8CEC	.	.	.
1G	Corsair	XMS2-5400	4	Corsair	DS	Heat-Sink Package	.	.	.
1G	HY	HYMP512U64CP8-Y5 AB	5	Hynix	DS	HY5PS12521CFP-Y5	.	.	.
512MB	Kingmax	KLCC28F-A8KB5	N/A	Kingmax	SS	KKEA88B4LAUG-29DX	.	.	.
1G	Kingmax	KLCD48F-A8KB5	N/A	Kingmax	DS	KKEA88B4LAUG-29DX	.	.	.
512MB	Apacer	AU512E667C5KBGC	5	Apacer	SS	AM4B5708GQJS7E06332F	.	.	.
512MB	Apacer	78.91G92.9K5	5	Apacer	SS	AM4B5708JQJS7E0751C	.	.	.
1G	Apacer	78.01G90.9K5	5	Apacer	SS	AM4B5808CQJS7E0751C	.	.	.
1G	Apacer	AU01GE667C5KBGC	N/A	Apacer	DS	AM4B5708GQJS7E0636B	.	.	.
1G	Apacer	AU01GE667C5KBGC	5	Apacer	DS	AM4B5708MJS7E0627B	.	.	.
2G	Apacer	78.A1G90.9K4	5	Apacer	DS	AM4B5808CQJS7E0749B	.	.	.
1G	Transcend	506010-4894	5	Elpida	DS	E5108AJBG-6E-E	.	.	.
512MB	ADATA	M2OAD5G3H3160Q1C52	N/A	ADATA	SS	AD29608A8A-3EG20813	.	.	.
1G	ADATA	M2OAD5G314170Q1C58	N/A	ADATA	DS	AD29608A8A-3EG80814	.	.	.
2G	ADATA	M2OAD5H3J4170I1C53	N/A	ADATA	DS	AD20908A8A-3EG 30724	.	.	.
512MB	PSC	AL6E8E63J-6E1	5	PSC	SS	A3R12E3JFF717B9A00	.	.	.
1G	PSC	AL7E8E63J-6E1	5	PSC	DS	A3R12E3JFF717B9A01	.	.	.
1G	PSC	AL7E8F73C-6E1	5	PSC	SS	A3R1GE3CFF734MAA0J	.	.	.
512MB	Nanya	NT512T64U88A1BY-3C	N/A	Nanya	SS	NT5TU64M8AE-3C	.	.	.
1G	Nanya	NT1GT64U8H80BY-3C	5	Nanya	DS	NT5TU64M8BE-3C72155700CP	.	.	.
1G	GEIL	GX21GB5300SX	3	GEIL	DS	Heat-Sink Package	.	.	.
2G	GEIL	GX22GB5300LX	5	GEIL	DS	Heat-Sink Package	.	.	.
2G	GEIL	GX24GB5300LDC	5	GEIL	DS	Heat-Sink Package	.	.	.
1G(kit of 2)	G.SKILL	F2-5400PHU2-2GBNT	5-5-5-15	G.SKILL	DS	D2 64M8CCF 0815 C7173S	.	.	.
2G(kit of 2)	G.SKILL	F2-5300CLD-4GBMQ	5-5-5-15	G.SKILL	DS	Heat-Sink Package	.	.	.
667 1G	Super Talent	T667UB1GV	5	Super Talent	DS	PG 64M8-800 0750	.	.	.
512MB	Twinmos	8D-A3JK5MPETP	5	PSC	SS	A3R12E3GEF633ACA0Y	.	.	.
4G	Samsung	M378T5263AZ3-CE6	N/A	Samsung	DS	K4T2G084QA-HCE6	.	.	.
1G	Kingtiger	E0736001024667	N/A	Kingtiger	DS	KTG667PS6408NST-C6 GDBTX	.	.	.
1G	ELIXIR	M2Y1G64TU8HA2B-3C	5	ELIXIR	DS	M2TU51280AE-3C717095R28F	.	.	.
1G	ELIXIR	M2Y1G64TU8HOB0B-3C	5	ELIXIR	DS	N2TU51280BE-3C639009W1CF	.	.	.
1G	Leadmax	LRMP512U64A8-Y5	N/A	Hynix	DS	HY5PS12821CFP-Y5 C 702AA	.	.	.



SS - Single-sided / DS - Double - sided**DIMM support:**

- **A***: Supports one module inserted into any slot as Single-channel memory configuration.
 - **B***: Supports one pair of modules inserted into either the yellow slots or the black slots as one pair of Dual-channel memory configuration.
 - **C***: Supports 4 modules inserted into both the yellow and black slots as two pairs of Dual-channel memory configuration.
-



Visit the [ASUS website](#) for the latest DDR2-1066/800/667MHz QVL.

2.5.2 Installing a DDR2 DIMM



Make sure to unplug the power supply before adding or removing DIMMs or other system components. Failure to do so may cause severe damage to both the motherboard and the components.

1. Unlock a DDR2 DIMM socket by pressing the retaining clips outward.
2. Align a DIMM on the socket such that the notch on the DIMM matches the break on the socket.

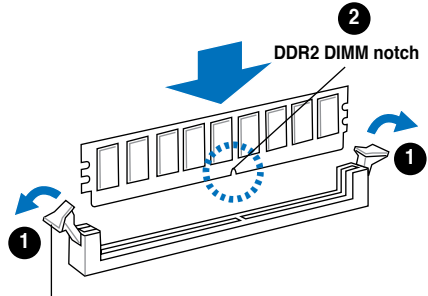

Unlocked retaining clip



A DDR2 DIMM is keyed with a notch so that it fits in only one direction. DO NOT force a DIMM into a socket to avoid damaging the DIMM.

3. Firmly insert the DIMM into the socket until the retaining clips snap back in place and the DIMM is properly seated.

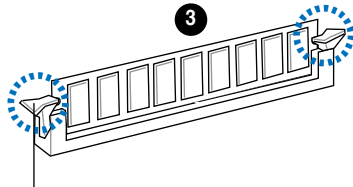

Locked Retaining Clip

2.5.3 Removing a DDR2 DIMM

Follow these steps to remove a DIMM.

1. Simultaneously press the retaining clips outward to unlock the DIMM.

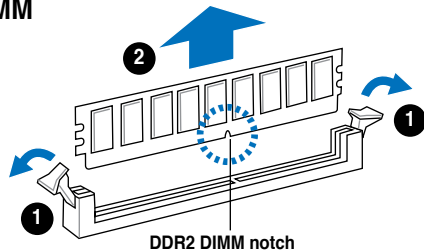

Support the DIMM lightly with your fingers when pressing the retaining clips. The DIMM might get damaged when it flips out with extra force.

2. Remove the DIMM from the socket.

2.6 Expansion slots

In the future, you may need to install expansion cards. The following sub-sections describe the slots and the expansion cards that they support.



Make sure to unplug the power cord before adding or removing expansion cards. Failure to do so may cause you physical injury and damage motherboard components.

2.6.1 Installing an expansion card

To install an expansion card:

1. Before installing the expansion card, read the documentation that came with it and make the necessary hardware settings for the card.
2. Remove the system unit cover (if your motherboard is already installed in a chassis).
3. Remove the bracket opposite the slot that you intend to use. Keep the screw for later use.
4. Align the card connector with the slot and press firmly until the card is completely seated on the slot.
5. Secure the card to the chassis with the screw you removed earlier.
6. Replace the system cover.

2.6.2 Configuring an expansion card

After installing the expansion card, configure it by adjusting the software settings.

1. Turn on the system and change the necessary BIOS settings, if any. See Chapter 5 for information on BIOS setup.
2. Assign an IRQ to the card. Refer to the tables on the next page.
3. Install the software drivers for the expansion card.



When using PCI cards on shared slots, ensure that the drivers support “Share IRQ” or that the cards do not need IRQ assignments. Otherwise, conflicts will arise between the two PCI groups, making the system unstable and the card inoperable.

Interrupt assignments

IRQ	Priority	Standard Function
0	1	System Timer
1	2	Keyboard controller
2	-	Re-direct to IRQ#9
3	10	Communications Port (COM1)
4	11	IRQ holder for PCI steering*
5	12	Standard Floppy Disk Controller
6	13	Printer Port (LPT1)
7	3	System CMOS/Real Time Clock
8	4	IRQ holder for PCI steering*
9	5	IRQ holder for PCI steering*
10	6	IRQ holder for PCI steering*
11	7	PS/2 Compatible Mouse Port
12	8	Numeric Data Processor
13	9	Primary IDE Channel

* These IRQs are usually available for PCI devices.

IRQ assignments for this motherboard

	A	B	C	D	E	F	G	H
PCI1	shared	shared	shared	shared	—	—	—	—
PCIEX1_1	shared	shared	shared	shared	—	—	—	—
PCIEX1_2	shared	shared	shared	shared	—	—	—	—
Onboard USB controller 1	—	—	—	—	—	—	—	shared
Onboard USB controller 2	—	—	—	shared	—	—	—	—
Onboard USB controller 3	—	—	shared	—	—	—	—	—
Onboard USB controller 4	shared	—	—	—	—	—	—	—
Onboard USB 2.0 controller	—	—	—	—	—	—	—	shared
Onboard HD audio	—	—	—	—	—	—	shared	—
Onboard LAN	—	used	—	—	—	—	—	—
Onboard 1394 controller	—	—	—	used	—	—	—	—
Onboard Marvell IDE controller	used	—	—	—	—	—	—	—

2.6.3 PCI slots

The PCI slots support cards such as a LAN card, SCSI card, USB card, and other cards that comply with PCI specifications. The figure shows a LAN card installed on a PCI slot.

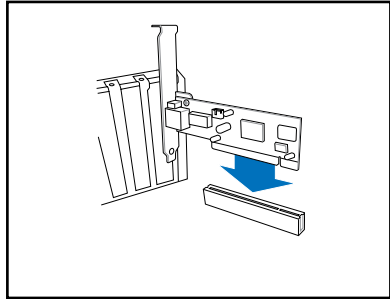

2.6.4 PCI Express x1 slot

This motherboard supports PCI Express x1 network cards, SCSI cards and other cards that comply with the PCI Express specifications. The figure shows a network card installed on the PCI Express x1 slot.

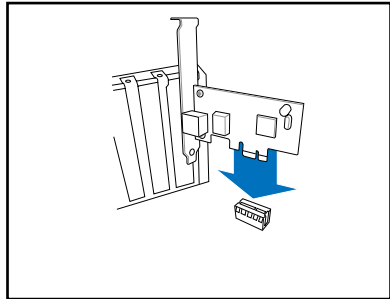

2.6.5 PCI Express x16 slot

This motherboard supports PCI Express x16 graphic cards that comply with the PCI Express specifications. The figure shows a graphics card installed on the PCI Express x16 slot.

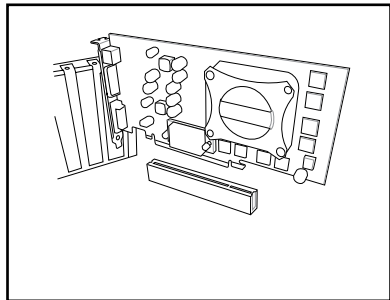

2.7 Installing an optical drive

Refer to the instructions in this section if you wish to install a new optical drive.

Follow these steps to install an optical drive:

1. Place the chassis upright.
2. Remove the drive slot metal plate cover.
3. Insert the optical drive into the upper 5.25-inch drive bay and carefully push the optical drive into the bay until its screw holes align with the holes on the bay as shown.
4. Secure the optical drive with two screws on both sides of the bay.

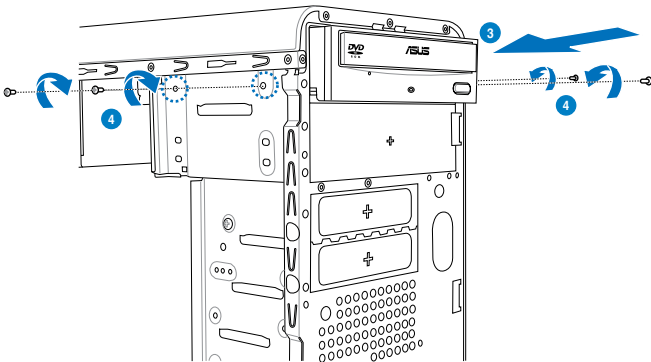

5. Connect a power cable from the power supply to the power connector at the back of the optical drive.
6. Connect one end of the IDE ribbon cable to the IDE interface at the back of the optical drive, matching the red stripe on the cable with Pin 1 on the IDE interface.

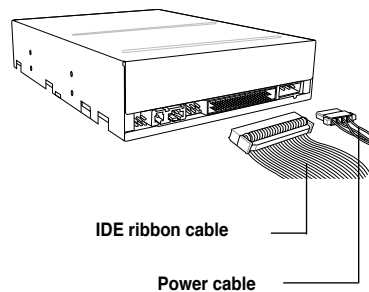

7. Connect the other end of the IDE ribbon cable to the secondary IDE connector (labeled SEC_IDE) on the motherboard. See page 4-7 for the location of this connector.
8. Remove the dummy drive slot cover from the front panel.
9. Replace the front panel.

2.8 Installing a hard disk drive

To install a Serial ATA hard disk drive:

1. Carefully place the hard disk into the the lowest 3.5-inch drive slot (without the metal plate cover).
2. Fasten the screws to secure the hard disk to the drive slot.

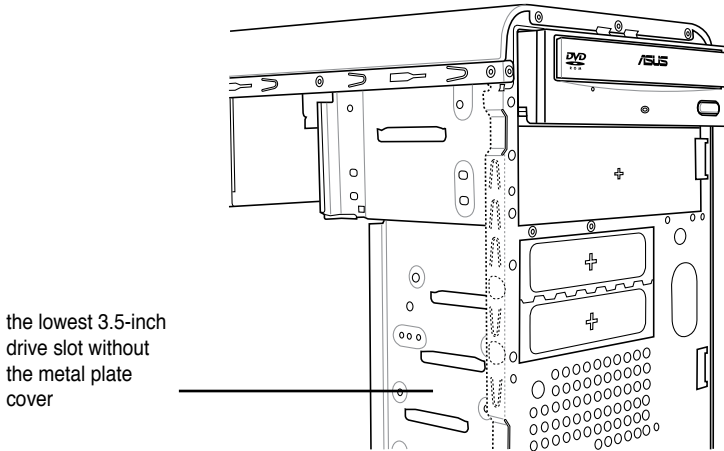

If you do not need to install the optional card reader into your system, you can install the HDD in the one of the 3.5-inch external bay (with the metal plate cover).

3. Connect one end of the Serial ATA cable to the SATA connector at the back of the drive, then connect the other end to a Serial ATA connector on the motherboard. See page 4-6 for the location of the Serial ATA connectors.

4. Connect a 15-pin Serial ATA power plug from the power supply unit to the 15-pin power connector at the back of the drive.

- OR -

Connect a 4-pin (female) power plug from the power supply unit to the 4-pin (male) power connector at the back of the drive.

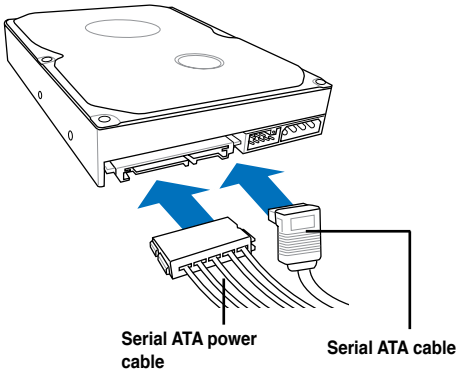

If your Serial ATA HDD has both 4-pin and 15-pin connectors at the back, use either the 15-pin SATA power adapter plug **OR** the legacy 4-pin power connector. **DO NOT** use both to prevent damage to components and to keep the system from becoming unstable.

To install an IDE hard disk drive:

1. Follow steps 1-2 of the previous section.
2. Connect the blue interface of the IDE ribbon cable to the primary IDE connector (blue connector labeled PRI_IDE) on the motherboard. See page 4-7 for the location of the connector.

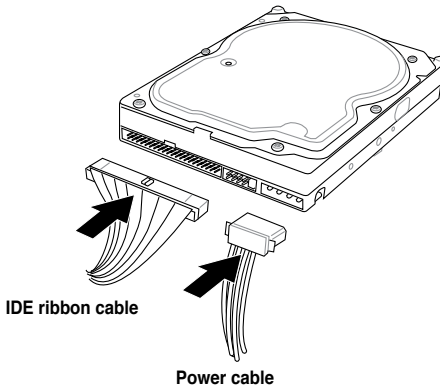



-
- If you will install only one hard disk drive, make sure to configure your hard disk drive as Master device before connecting the IDE cable and power plug. Refer to the HDD documentation on how to set the drive as a Master device.
 - If you will install two IDE hard disk drives, configure the other device as Slave.
-

3. Connect the gray interface of the IDE ribbon cable to the IDE connector on the drive.
4. If you install two IDE hard disk drives, connect the black interface of the IDE ribbon cable to the IDE connector on the second (Slave) IDE hard disk drive.
5. Connect a 4-pin power plug from the power supply unit to the power connector at the back of the drive(s).

2.9 Installing the card reader

An optional card reader module (see the figure below) is available with the system. If you want to install the card reader into your system, follow the steps on the next page.

Note: the card reader is optional and users need to purchase separately.



To install the card reader module:

1. Remove the drive slot metal plate cover.
2. Carefully insert the card reader module into the 3.5-inch bay until the screw holes align with the holes on the bay.
3. Secure the card reader module with two screws on both sides.

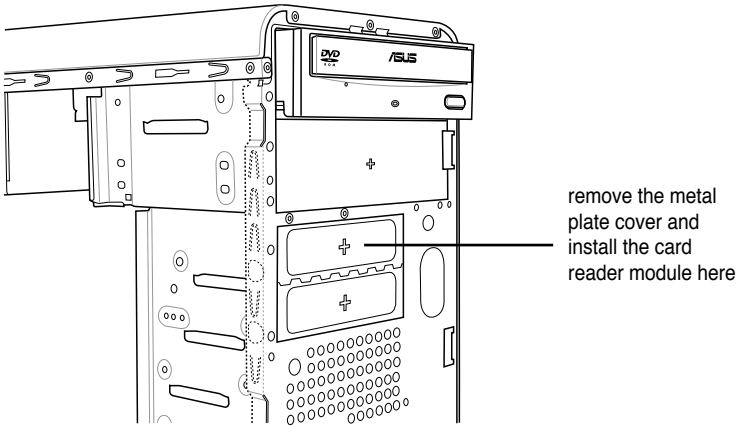

4. Connect the USB cable of the card reader to the USB connector on the motherboard.

2.10 Installing a floppy disk drive

The system comes with one 3.25-inch drive bay for a floppy disk drive.

To install a floppy disk drive:

1. Remove the drive slot metal plate cover.

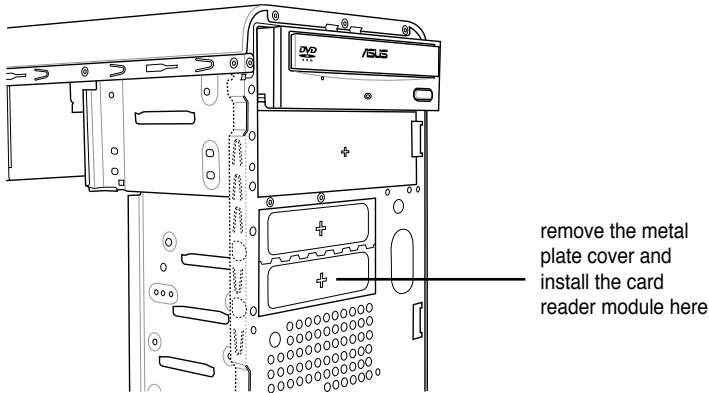

2. Carefully insert the floppy disk drive into the floppy drive bay until the screw holes align with the holes on the bay.
3. Secure the floppy disk drive with two screws on both sides.

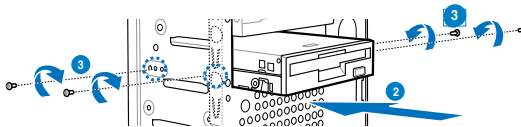

4. Connect the floppy disk drive signal cable to the signal connector at the back of the drive.

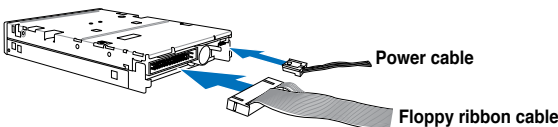

5. Connect the other end of the signal cable to the floppy disk drive connector on the motherboard. See page 4-6 for the location of the floppy disk drive connector.
6. Connect a 4-pin power cable from the power supply unit to the power connector at the back of the floppy disk drive.

2.11 Re-connecting cables

You may have disconnected some cables when you were installing components. You must re-connect these cables before you replace the chassis cover.

LED cables

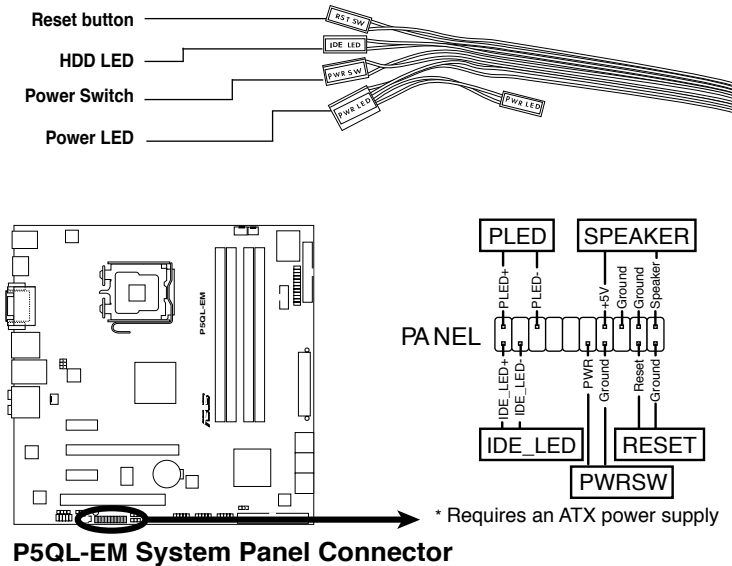

Connect the reset button, power switch, power LED, and HDD LED cables to their respective leads in the system panel connector on the motherboard.

2.12 Reinstalling the cover

If you installed an optical and/or floppy disk drive, remove the bay cover(s) on the front panel assembly before reinstalling it to the chassis. To do this:

1. Locate the bay cover locks.
2. Press the locks outward to release the bay cover.
3. Push the bay cover inward, then set it aside.
4. Follow the same instructions to remove the 3.5" drive bay cover.

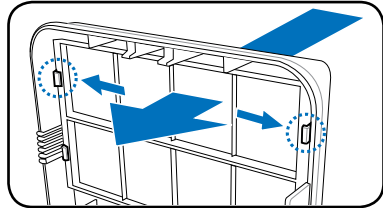

To reinstall the front panel assembly and side cover:

1. Insert the front panel assembly hinge-like tabs to the holes on the right side of the chassis.
2. Swing the front panel assembly to the left, then insert the hooks to the chassis until the front panel assembly fits in place.
3. Insert the six side cover hooks into the chassis tab holes.
4. Push the side cover to the direction of the front panel until it fits in place.
5. Secure the cover with two screws you removed earlier.



If the air duct interferes with the CPU fan, adjust the air duct accordingly.

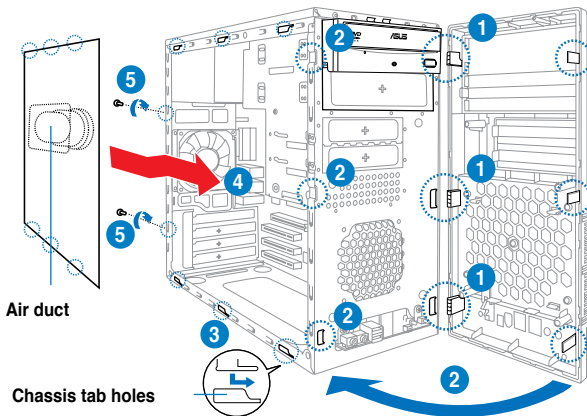

Chapter 3

This chapter helps you power up the system and install drivers and utilities from the support DVD.

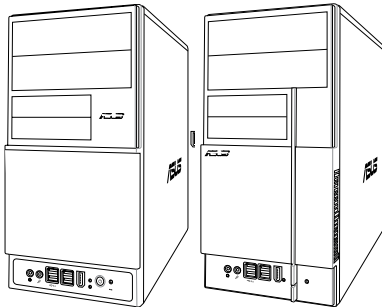

Starting up

3.1 Installing an operating system

The barebone system supports Windows® XP/Vista operating systems (OS). Always install the latest OS version and corresponding updates so you can maximize the features of your hardware.



Because motherboard settings and hardware options vary, use the setup procedures presented in this chapter for general reference only. Refer to your OS documentation for more information.



- Windows XP OS setup cannot recognize Serial ATA hard drives without the necessary drivers. Use the bundled floppy disk when installing Windows XP OS to a Serial ATA hard drive.
- From the Windows XP setup screen, press F6 when prompted then follow succeeding screen instructions to install the SATA drivers.

3.2 Powering up

Press the system power button (⏻) to enter the OS.

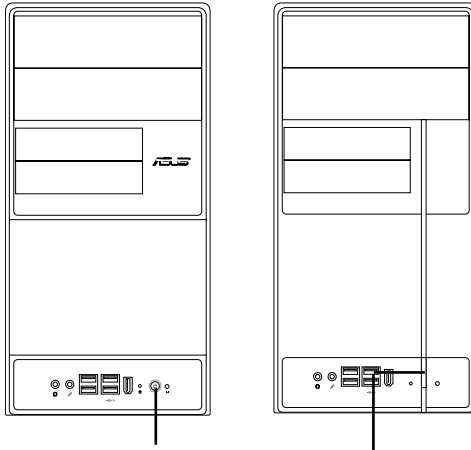

Press to turn ON the system

3.3 Support DVD information

The support DVD that came with the system contains useful software and several utility drivers that enhance the system features.



- Screen display and driver options may not be the same for different operating system versions.
- The contents of the support DVD are subject to change at any time without notice. Visit the ASUS website for updates.

3.3.1 Running the support DVD

To begin using the support DVD, place the DVD in your optical drive. The DVD automatically displays the Drivers menu if Autorun is enabled in your computer.

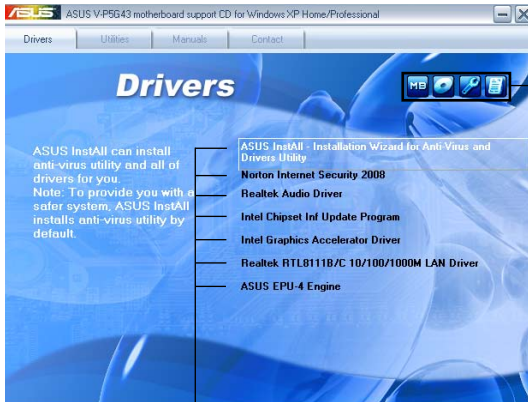

Click an icon to display support DVD/motherboard information

Click an item to install



If Autorun is NOT enabled in your computer, browse the contents of the support DVD to locate the file ASSETUP.EXE from the BIN folder. Double-click the ASSETUP.EXE to run the DVD.

ASUS InstAll-Installation Wizard for Anti-Virus and Drivers Utility

Launches the ASUS InstAll driver installation wizard.

Norton Internet Security 2008

Installs the Norton Internet Security 2008.

Realtek Audio Driver

Installs the Realtek® ALC1200 audio driver and application.

Intel Chipset Inf Update Program

Installs the Intel® chipset Inf update program.

Intel Graphics Accelerator Driver

Installs the Intel® Graphics accelerator driver.

Realtek RTL8111B/C 10/100/1000M LAN Driver

Installs the Realtek® RTL8111B/C 10/100/1000M LAN Driver.

ASUS EPU-4 Engine

Installs the ASUS EPU-4 Engine.

3.3.2 Utilities menu

The Utilities menu shows the applications and other software that the motherboard supports.

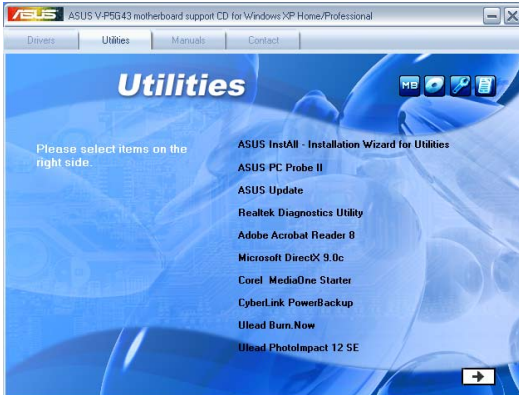

ASUS InstAll-Installation Wizard for Utilities

Installs all of the utilities through the Installation Wizard.

ASUS Update

Allows you to download the latest version of the BIOS from the ASUS website.



Before using the ASUS Update, make sure that you have an Internet connection so you can connect to the ASUS website.

ASUS PC Probe II

This smart utility monitors the fan speed, CPU temperature, and system voltages, and alerts you of any detected problems. This utility helps you keep your computer in healthy operating condition.

Realtek Diagnostics Utility

Installs the Realtek® diagnostics utility

Adobe Acrobat Reader 8

Installs the Adobe® Acrobat® Reader that allows you to open, view, and print documents in Portable Document Format (PDF).

Microsoft DirectX 9.0c

Installs the Microsoft® DirectX 9.0c driver. The Microsoft DirectX® 9.0c is a multimedia technology that enhances computer graphics and sound. DirectX® improves the multimedia features of your computer so you can enjoy watching TV and movies, capturing videos, or playing games in your computer. Visit the Microsoft website (www.microsoft.com) for updates.

Corel MediaOne Starter

Installs the Corel MediaOne Starter application to easily manage, edit share and protect your multimedia data.

CyberLink PowerBackup

Installs CyberLink PowerBackup to back up and restore your data easily.

Ulead Burn. Now

Installs the Ulead Burn. Now application for Audio DVD, CD and data disc creation.

Ulead PhotoImpact 12 SE

Installs the PhotoImpact image editing software.



You can also install the following utilities from the ASUS Superb Software Library DVD.

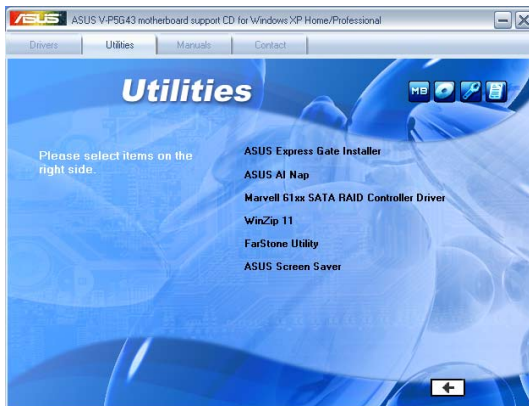

ASUS Express Gate Installer

Installs the ASUS Express Gate Installer.

ASUS AI Nap

Installs the ASUS AI Nap.

Marvell 61xx SATA RAID Controller Driver

Installs the Marvell 61xx SATA RAID controller driver.

FarStone Utility

Installs the FarStone utility.

ASUS Screen Saver

Installs the ASUS Screen saver.

3.3.3 Manual menu

The Manual menu contains a list of supplementary user manuals. Click an item to open the folder of the user manual.



Most user manual files are in Portable Document Format (PDF). Install the Adobe® Acrobat® Reader from the ASUS Superb Software Library DVD before opening a user manual file.

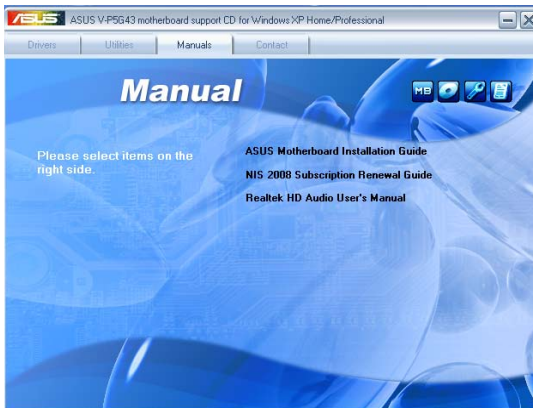

ASUS Motherboard Installation Guide

Allows you to open the ASUS Motherboard Installation Guide.

NIS 2008 Subscription Renewal Guide

Allows you to open the NIS 2008 Subscription Renewal Guide.

Realtek HD Audio User's Manual

Allows you to open the Realtek HD Audio User's manual.

3.3.4 ASUS Contact information

Click the Contact tab to display the ASUS contact information. You can also find this information on the inside front cover of this user guide.

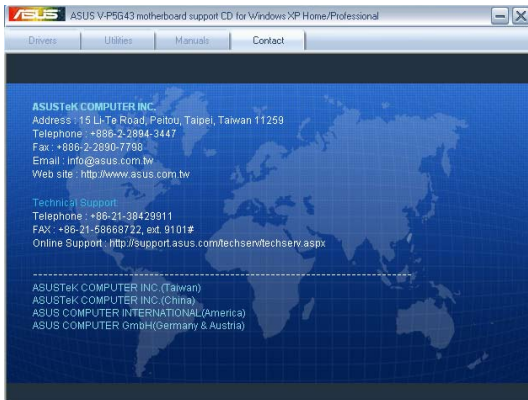

3.3.5 Other information

The icons on the top right corner of the screen give additional information on the motherboard and the contents of the support DVD. Click an icon to display the specified information.

Motherboard Info

Displays the general specifications of the motherboard.

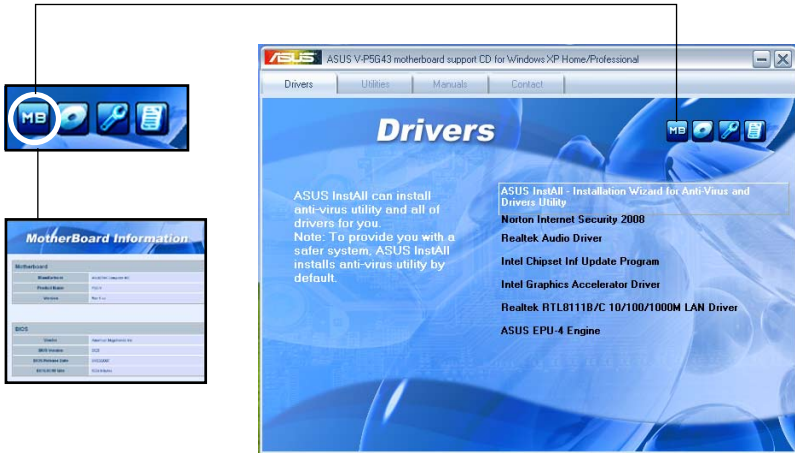

Browse this DVD

Displays the support DVD contents in graphical format.

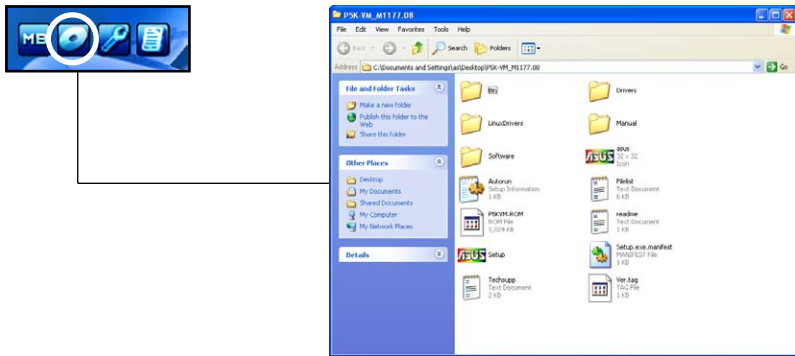

Technical support Form

Displays the ASUS Technical Support Request Form that you have to fill out when requesting technical support.



ASUS® TECHNICAL SUPPORT REQUEST FORM

ORIGINATOR DESCRIPTION

COMPANY NAME :	CONTRACT NAME :
PHONE (AREA) :	FAX # (AREA) :
EMAIL ADDRESS :	

HARDWARE DESCRIPTION

MOTHERBOARD :	REVISION #1 :	81051#A01AD-
CPU BRAND :	SPEED(MHz) :	
DRAM BRAND :	SPEED(MHz) :	
CACHE BRAND :	SPEED(MHz) :	
RAID CHIP :	MODEL NAME :	
CDROM BRAND :	MODEL NAME :	
BACKUP BRAND :	MODEL NAME :	
OTHER STORAGE :	MODEL NAME :	

ADD-IN CARD DESCRIPTION (MODEL NAME/VENDOR)

(E)ISA SLOT 1 :	
(E)ISA SLOT 2 :	
(E)ISA SLOT 3 :	
(E)ISA SLOT 4 :	
PCI-E SLOT 1 :	
PCI-E SLOT 2 :	
PCI-E SLOT 3 :	
PCI-E SLOT 4 :	
PCI SLOT 1 :	
PCI SLOT 2 :	
PCI SLOT 3 :	
PCI SLOT 4 :	
PCI SLOT 5 :	

Filelist

Displays the contents of the support DVD and a brief description of each in text format.



File list for the included support software for P5K-VM motherboard

File Name	Description
-Drivers	
-Chipset	
-i386	-intel(x) chipset software installation utility v8.1.0.1053 for windows
-VGA	
-xp	-intel(x) Graphics Media Accelerator Driver v8.14.10.4820 for windows x
-vista	-intel(x) Graphics Media Accelerator Driver v7.14.10.1255 for windows 2
-Audio	
	-realtek ALC883 Audio driver v5.10.0.1366 for windows xp & 64bit xp(wow
	-realtek ALC883 Audio driver v6.0.1.5371 for windows vista and windows
-LAN	
-8056	
-xp_2003_64bit	-marvell yukon gigabit ethernet driver v8.56.6.3 for windows xp(wow)
-VCT	-marvell yukon VCT application v2.11.1.3 for windows xp/ 64bit xp
-i386	-marvell UNDI Driver For ET1310 v2.02
-client_32	-marvell yukon client 32 driver v7.03
-OOI	-marvell OOI driver v7.05
-Network	
	-marvell yukon network 4.0 driver v7.03
	-marvell yukon network 3.1.0 driver v7.03
-linux	-marvell SCO firmware 7.1.1 v driver and openmfx 8.0.
-RIS	-marvell RIS driver v8.56.1.3 for windows xp.
	-marvell RIS driver v8.56.1.3 for windows 64bit xp.
-vista	-marvell yukon gigabit ethernet driver v8.56.6.3 for windows vista and windows

3.4 Software information

Most of the applications in the support DVD have wizards that will conveniently guide you through the installation. View the online help or readme file that came with the software for more information.

ASUS PC Probe II

PC Probe II is a utility that monitors the computer's vital components and alerts you of any problem with these components. PC Probe II senses fan rotations, CPU temperature, and system voltages, among others. PC Probe II is software-based, allowing you to start monitoring your computer the moment you turn it on. With this utility, you are assured that your computer is always at a healthy operating condition.

Installing PC Probe II

To install PC Probe II on your computer:

1. Place the support DVD to the optical drive. The Drivers installation tab appears if your computer has an enabled Autorun feature.



If Autorun is not enabled in your computer, browse the contents of the support CD to locate the setup.exe file from the ASUS PC Probe II folder. Double-click the setup.exe file to start installation.

2. Click the **Utilities** tab, then click **ASUS PC Probe II**.
3. Follow the screen instructions to complete installation.

Launching PC Probe II

You can launch the PC Probe II right after installation or anytime from the Windows® desktop.

To launch the PC Probe II from the Windows® desktop, click **Start > All Programs > ASUS > PC Probe II**. The PC Probe II main window appears.

After launching the application, the PC Probe II icon appears in the Windows® taskbar. Click this icon to close or restore the application.











Click to close the Preference panel

Using PC Probe II

Main window

The PC Probe II main window allows you to view the current status of your system and change the utility configuration. By default, the main window displays the **Preference** section. You can close or restore the **Preference** section by clicking on the triangle on the main window right handle.

Button	Function
	Opens the Configuration window
	Opens the Report window
	Opens the Desktop Management Interface window
	Opens the Peripheral Component Interconnect window
	Opens the Windows Management Instrumentation window
	Opens the hard disk drive, memory, CPU usage window
	Shows/Hides the Preference section
	Minimizes the application
	Closes the application

Sensor alert

When a system sensor detects a problem, the main window right handle turns red, as the illustrations below show.

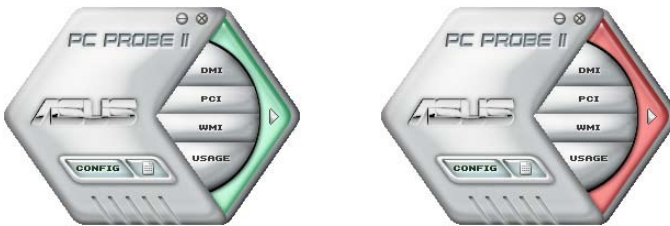

When displayed, the monitor panel for that sensor also turns red. Refer to the **Monitor panels** section for details.

Preferences

You can customize the application using the Preference section in the main window. Click the box before each preference to activate or deactivate.

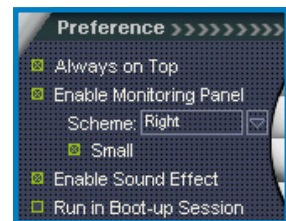

Hardware monitor panels

The hardware monitor panels display the current value of a system sensor such as fan rotation, CPU temperature, and voltages.

The hardware monitor panels come in two display modes: hexagonal (large) and rectangular (small). When you check the **Enable Monitoring Panel** option from the **Preference** section, the monitor panels appear on your computer's desktop.



Large display



Small display

Changing the monitor panels position

To change the position of the monitor panels on the desktop, click the arrow down button of the **Scheme** options, then select another position from the list box. Click **OK** when finished.

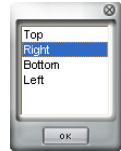

Moving the monitor panels

All monitor panels move together using a magnetic effect. If you want to detach a monitor panel from the group, click the horseshoe magnet icon. You can now move or reposition the panel independently.

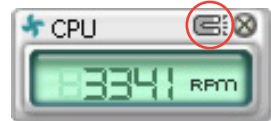

Adjusting the sensor threshold value

You can adjust the sensor threshold value in the monitor panel by clicking the arrow buttons. You can also adjust the threshold values using the **Config** window.

You cannot adjust the sensor threshold values in a small monitoring panel.

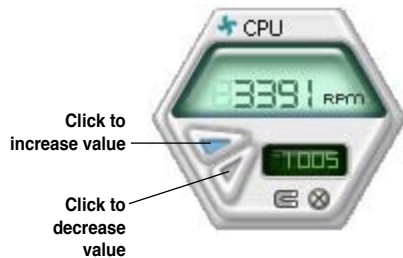

Monitoring sensor alert

The monitor panel turns red when a component value exceeds or is lower than the threshold value. Refer to the illustrations below.



Large display



Small display

WMI browser

Click **WMI** to display the WMI (Windows Management Instrumentation) browser. This browser displays various Windows® management information. Click an item from the left panel to display on the right panel. Click the plus sign (+) before **WMI Information** to display the available information.

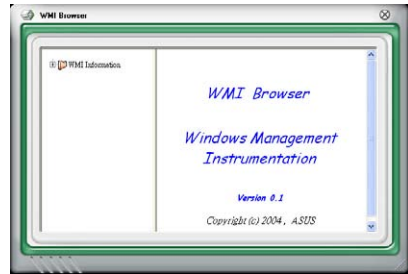

You can enlarge or reduce the browser size by dragging the bottom right corner of the browser.

DMI browser

Click **DMI** to display the DMI (Desktop Management Interface) browser. This browser displays various desktop and system information. Click the plus sign (+) before **DMI Information** to display the available information.

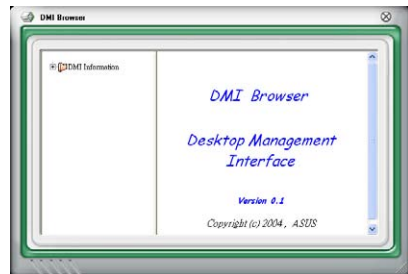

PCI browser

Click **PCI** to display the PCI (Peripheral Component Interconnect) browser. This browser provides information on the PCI devices installed on your system. Click the plus sign (+) before the **PCI Information** item to display available information.

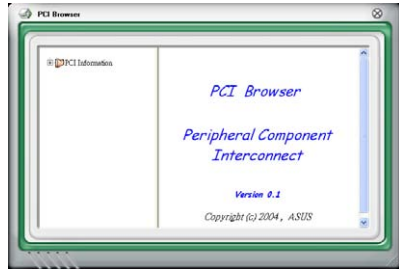

Usage

The **Usage** browser displays real-time information on the CPU, hard disk drive space, and memory usage. Click **USAGE** to display the Usage browser.

CPU usage

The **CPU** tab displays real-time CPU usage in line graph representation. If the CPU has an enabled Hyper-Threading, two separate line graphs display the operation of the two logical processors.

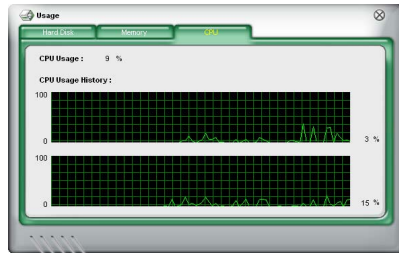

Hard disk drive space usage

The **Hard Disk** tab displays the used and available hard disk drive space. The left panel of the tab lists all logical drives. Click a hard disk drive to display the information on the right panel. The pie chart at the bottom of the window represents the used (blue) and the available HDD space.

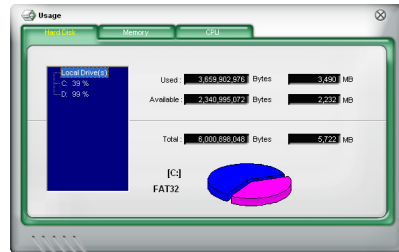

Memory usage

The **Memory** tab shows both used and available physical memory. The pie chart at the bottom of the window represents the used (blue) and the available physical memory.

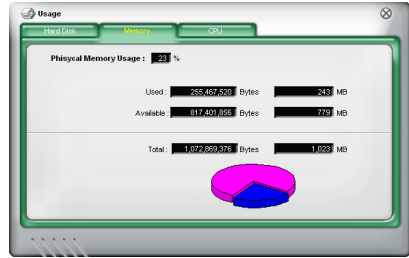

Configuring PC Probe II

Click **CONFIG** to view and adjust the sensor threshold values.

The **Config** window has two tabs: **Sensor/Threshold** and **Preference**. The **Sensor/Threshold** tab enables you to activate the sensors or to adjust the sensor threshold values. The **Preference** tab allows you to customize sensor alerts, change temperature scale, or enable the Q-Fan feature.

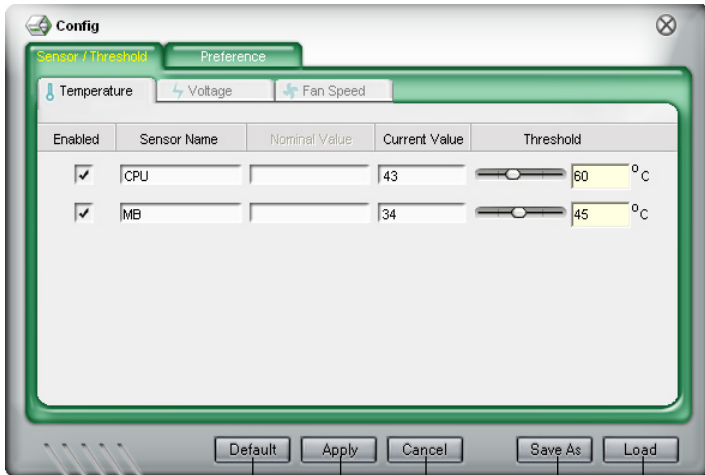

Loads the default threshold values for each sensor

Applies your changes

Cancels or ignores your changes

Loads your saved configuration
Saves your configuration

Chapter 4

This chapter gives information about the motherboard that comes with the system. This chapter includes the motherboard layout, jumper settings, and connector locations.

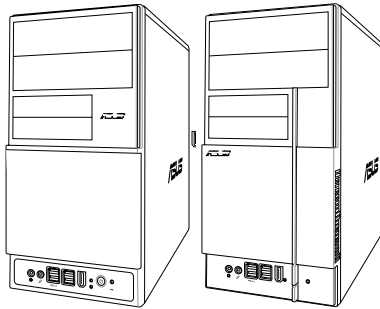

4.1 Introduction

The Vintage V-Series P5G33 barebone system comes with an ASUS motherboard. This chapter provides technical information about the motherboard for future upgrades or system reconfiguration.

4.2 Motherboard layout

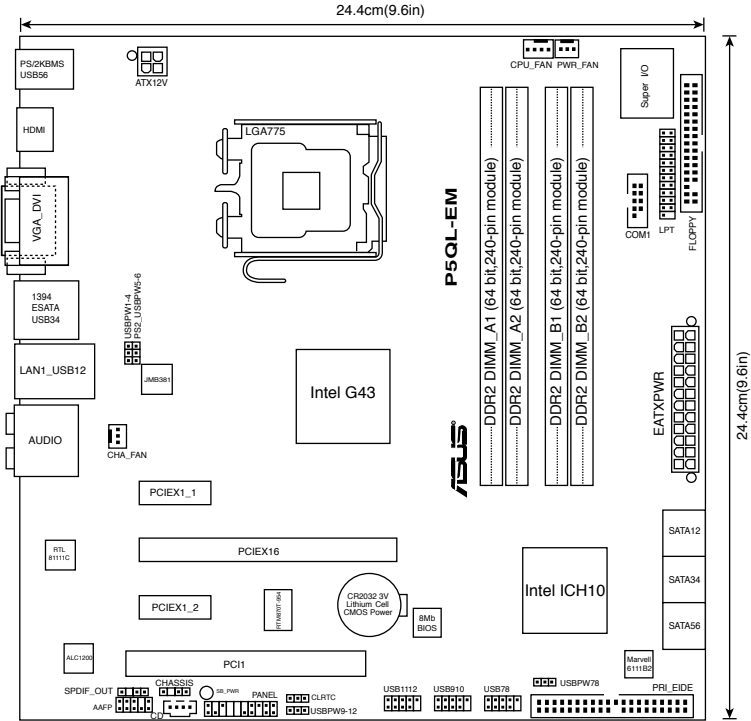

4.3 Jumpers

1. Clear RTC RAM (CLRRTC)

This jumper allows you to clear the Real Time Clock (RTC) RAM in CMOS. You can clear the CMOS memory of date, time, and system setup parameters by erasing the CMOS RTC RAM data. The onboard button cell battery powers the RAM data in CMOS, which include system setup information such as system passwords.

To erase the RTC RAM:

1. Turn OFF the computer and unplug the power cord.
2. Remove the onboard battery.
3. Move the jumper cap from pins 1-2 (default) to pins 2-3. Keep the cap on pins 2-3 for about 5~10 seconds, then move the cap back to pins 1-2.
4. Re-install the battery.
5. Plug the power cord and turn ON the computer.
6. Hold down the key during the boot process and enter BIOS setup to re-enter data.



Except when clearing the RTC RAM, never remove the cap on CLRRTC jumper default position. Removing the cap will cause system boot failure!

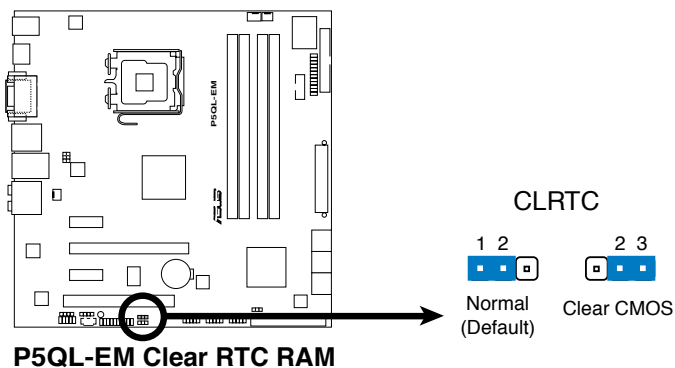

You do not need to clear the RTC when the system hangs due to overclocking. For system failure due to overclocking, use the C.P.R. (CPU Parameter Recall) feature. Shut down and reboot the system so the BIOS can automatically reset parameter settings to default values.

2. USB device wake-up (3-pin USBPW1-4, USBPW5-8, USBPW9-12)

Set these jumpers to +5V to wake up the computer from S1 sleep mode (CPU stopped, DRAM refreshed, system running in low power mode) using the connected USB devices. Set to +5VSB to wake up from S3 and S4 sleep modes.

The USBPW1-4 jumpers are for the rear USB ports. The USBPW5-8 and USBPW9-10 jumpers are for the internal USB connectors that you can connect to additional USB ports.

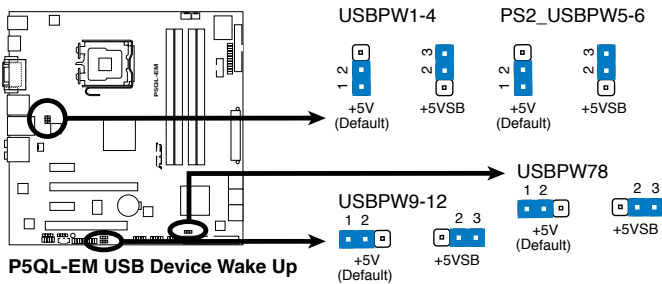

P5QL-EM USB Device Wake Up



- The USB device wake-up feature requires a power supply that can provide 500mA on the +5VSB lead for each USB port; otherwise, the system will not power up.
- The total current consumed must NOT exceed the power supply capability (+5VSB) whether under normal condition or in sleep mode.

4.3 Connectors

1. Floppy disk drive connector (34-1 pin FLOPPY)

This connector is for the provided floppy disk drive (FDD) signal cable. Insert one end of the cable to this connector, then connect the other end to the signal connector at the back of the floppy disk drive.



Pin 5 on the connector is removed to prevent incorrect cable connection when using an FDD cable with a covered Pin 5.

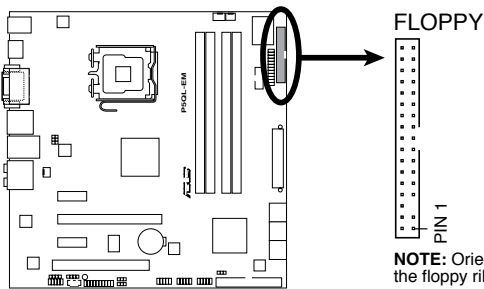

P5QL-EM Floppy Disk Drive Connector

NOTE: Orient the red markings on the floppy ribbon cable to PIN 1.

2. IDE connector (40-1 pin PRI_IDE)

The onboard IDE connector is for Ultra DMA 133 / 100 / 66 / 33 signal cable. There are three connectors on each Ultra DMA 100/66/33 signal cable: blue, black, and gray. Connect the blue connector to the motherboard's IDE connector, then select one of the following modes to configure your device(s).

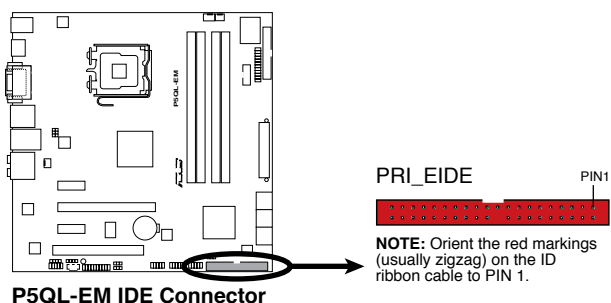

	Drive jumper setting	Mode of device(s)	Cable connector
Single device	Cable-Select or Master	-	Black
Two devices	Cable-Select	Master	Black
		Slave	Gray
	Master	Master	Black or gray
	Slave	Slave	



- Pin 20 on the IDE connector is removed to match the covered hole on the Ultra DMA cable connector. This prevents incorrect insertion when you connect the IDE cable.
- Use the 80-conductor IDE cable for Ultra DMA 133 / 100 / 66 / 33 IDE devices.



If any device jumper is set as "Cable-Select," ensure that all other device jumpers have the same setting.

3. ICH9 Serial ATA connectors (7-pin SATA1 [red], SATA2 [black], SATA3 [red], SATA4 [black])

These connectors are for the Serial ATA signal cables for Serial ATA hard disk drives.

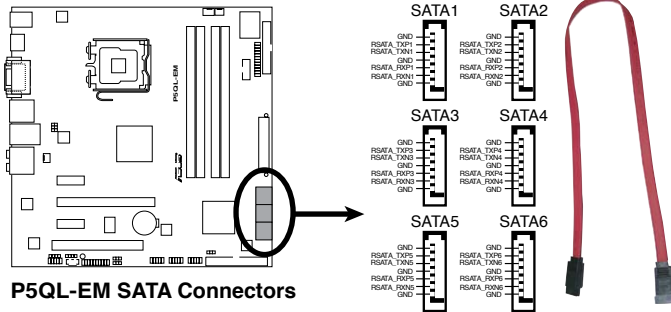

Connect the right-angle side of SATA signal cable to SATA device. Or you may connect the right-angle side of SATA cable to the onboard SATA port to avoid mechanical conflict with huge graphics cards.

right angle side

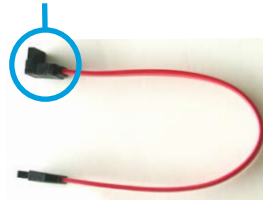

4. Digital audio connector (4-1 pin SPDIF_OUT for ASUS HDMI VGA card)

This connector is for an additional Sony/Philips Digital Interface (S/PDIF) port(s). If you are using an ASUS HDMI-equipped graphics card, connect the HDMI card to this connector with a S/PDIF Out cable.

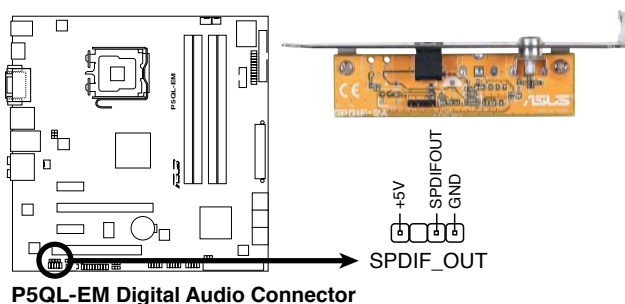

The ASUS HDMI-equipped graphics card and the S/PDIF Out cable are purchased separately.

5. USB connectors (10-1 pin USB78, USB 910, USB1112)

These connectors are for USB 2.0 ports. Connect the USB module cable to any of these connectors, then install the module to a slot opening at the back of the system chassis. These USB connectors comply with USB 2.0 specification that supports up to 480 Mbps connection speed.

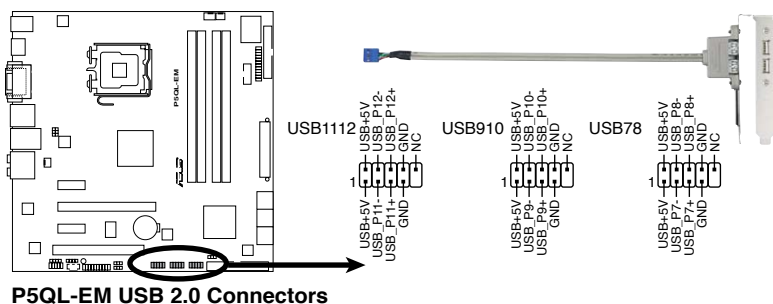

Never connect a 1394 cable to the USB connectors. Doing so will damage the motherboard!



You can connect the front panel USB cable to the ASUS Q-Connector (USB, blue) first, and then install the Q-Connector (USB) to the USB connector onboard if your chassis supports front panel USB ports.



The USB module cable is purchased separately.

6. Optical drive audio connector (4-pin CD)

These connectors allow you to receive stereo audio input from sound sources such as a CD-ROM, TV tuner, or MPEG card.

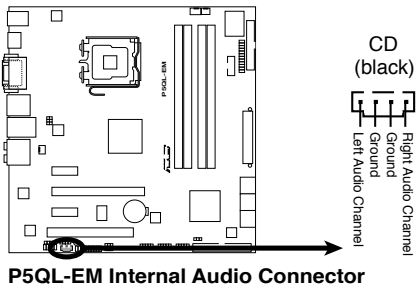

7. Digital Audio connector (4-1 pin SPDIF_OUT)

This connector is for the S/PDIF audio module to allow digital sound output. Connect one end of the S/PDIF audio cable to this connector and the other end to the S/PDIF module.

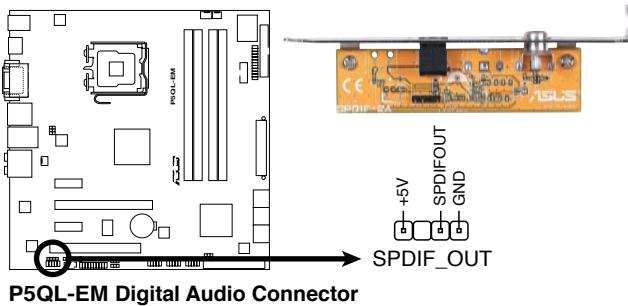

The S/PDIF out module is purchased separately.

8. CPU, chassis, and power fan connectors (4-pin CPU_FAN, 3-pin CHA_FAN1, 3-pin PWR_FAN)

The fan connectors support cooling fans of 350 mA~2000 mA (24 W max.) or a total of 1 A~7 A (84 W max.) at +12V. Connect the fan cables to the fan connectors on the motherboard, making sure that the black wire of each cable matches the ground pin of the connector.



Do not forget to connect the fan cables to the fan connectors. Insufficient air flow inside the system may damage the motherboard components. These are not jumpers! Do not place jumper caps on the fan connectors!

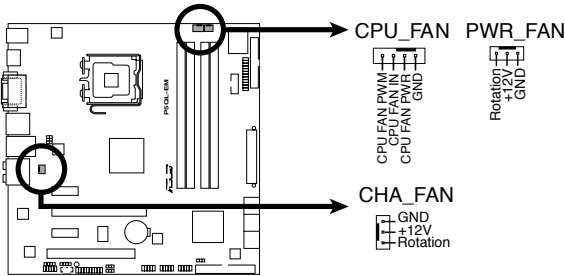

P5QL-EM Fan Connectors



Only the CPU-FAN connectors support the ASUS Q-FAN feature.

9. Serial port connector (10-1 pin COM1)

This connector is for a serial (COM) port. Connect the serial port module cable to this connector, then install the module to a slot opening at the back of the system chassis.

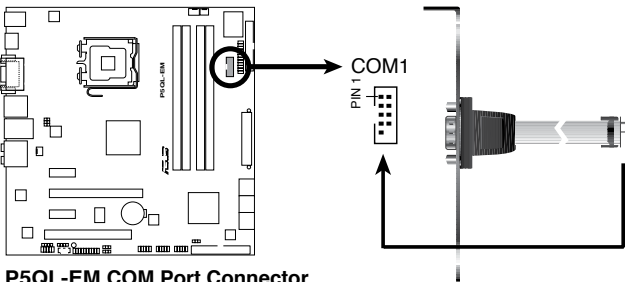

P5QL-EM COM Port Connector



The serial port module is purchased separately.

10. Chassis intrusion connector (4-1 pin CHASSIS)

This connector is for a chassis-mounted intrusion detection sensor or switch. Connect one end of the chassis intrusion sensor or switch cable to this connector. The chassis intrusion sensor or switch sends a high-level signal to this connector when a chassis component is removed or replaced. The signal is then generated as a chassis intrusion event.

By default, the pin labeled “Chassis Signal” and “Ground” are shorted with a jumper cap. Remove the jumper caps only when you intend to use the chassis intrusion detection feature.

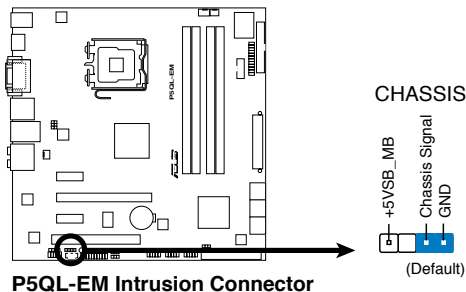

11. Front panel audio connector (10-1 pin AAFP)

This connector is for a chassis-mounted front panel audio I/O module that supports either HD Audio or legacy AC'97 audio standard. Connect one end of the front panel audio I/O module cable to this connector.

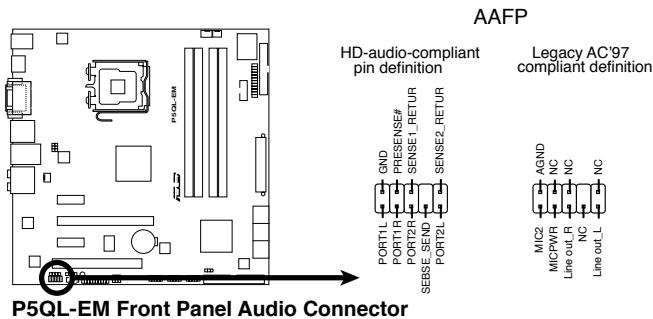

- We recommend that you connect a high-definition front panel audio module to this connector to avail of the motherboard's high-definition audio capability.
- If you want to connect a high-definition front panel audio module to this connector, set the **Front Panel Type** item in the BIOS setup to **[HD Audio]**; if you want to connect an AC'97 front panel audio module to this connector, set the item to **[AC'97]**. By default, this connector is set to **[HD Audio]**. See section 5.4.5 **Onboard Devices Configuration** for details.

12. ATX power connectors (24-pin EATXPWR, 4-pin ATX12V)

These connectors are for ATX power supply plugs. The power supply plugs are designed to fit these connectors in only one orientation. Find the proper orientation and push down firmly until the connectors completely fit.

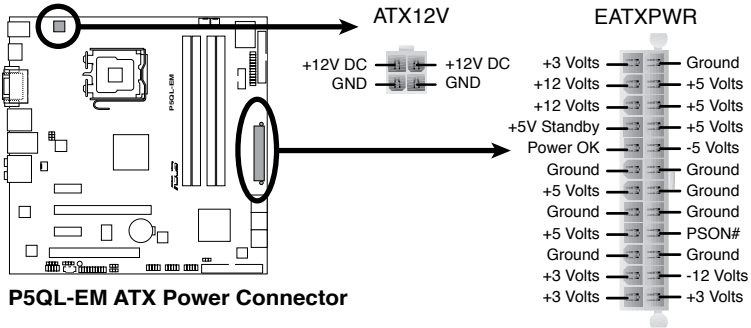

- For a fully configured system, we recommend that you use a power supply unit (PSU) that complies with ATX 12 V Specification 2.0 (or later version) and provides a minimum power of 400 W.
- Do not forget to connect the 4-pin EATX12V power plug; otherwise, the system will not boot.
- Use of a PSU with a higher power output is recommended when configuring a system with more power-consuming devices. The system may become unstable or may not boot up if the power is inadequate.
- The ATX 12 V Specification 2.0-compliant (400W) PSU has been tested to support the motherboard power requirements with the following configuration:
CPU: Intel® Pentium® Extreme 3.73GHz
Memory: 512 MB DDR2 (x4)
Graphics card: ASUS EAX1900XT
Parallel ATA device: IDE hard disk drive
Serial ATA device: SATA hard disk drive (x2)
Optical drive: DVD-RW
- If you want to use two high-end PCI Express x16 cards, use a PSU with 500W to 600W power or above to ensure the system stability.

13. System panel connector (20-8 pin F_PANEL)

This connector supports several chassis-mounted functions.

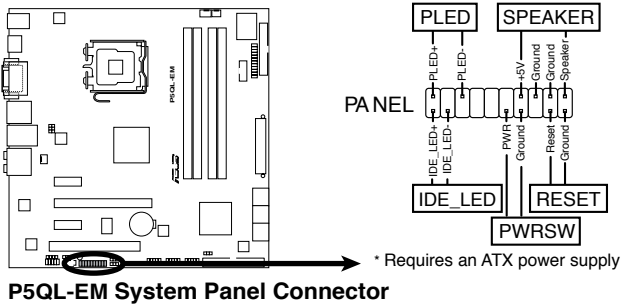

P5QL-EM System Panel Connector

- **System power LED (2-pin PLED)**

This 2-pin connector is for the system power LED. Connect the chassis power LED cable to this connector. The system power LED lights up when you turn on the system power, and blinks when the system is in sleep mode.

- **Hard disk drive activity LED (2-pin IDE_LED)**

This 2-pin connector is for the HDD Activity LED. Connect the HDD Activity LED cable to this connector. The IDE LED lights up or flashes when data is read from or written to the HDD.

- **System warning speaker (4-pin SPEAKER)**

This 4-pin connector is for the chassis-mounted system warning speaker. The speaker allows you to hear system beeps and warnings.

- **ATX power button/soft-off button (2-pin PWRSW)**

This connector is for the system power button. Pressing the power button turns the system on or puts the system in sleep or soft-off mode depending on the BIOS settings. Pressing the power switch for more than four seconds while the system is ON turns the system OFF.

- **Reset button (2-pin RESET)**

This 2-pin connector is for the chassis-mounted reset button for system reboot without turning off the system power.

Chapter 5

This chapter tells how to change system settings through the BIOS Setup menus and describes the BIOS parameters.

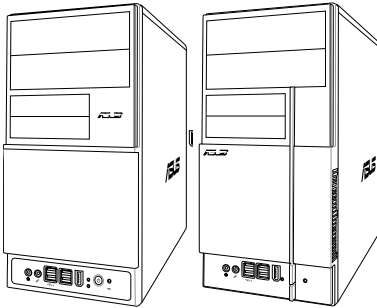

BIOS setup

5.1 Managing and updating your BIOS

The following utilities allow you to manage and update the motherboard Basic Input/Output System (BIOS) setup.

1. **ASUS Update** (Updates the BIOS in Windows® environment.)
2. **ASUS EZ Flash 2** (Updates the BIOS using a floppy disk or USB flash disk.)
3. **ASUS AFUDOS** (Updates the BIOS using a bootable floppy disk.)
4. **ASUS CrashFree BIOS 3** (Updates the BIOS using a bootable floppy disk, USB flash disk or the motherboard support DVD when the BIOS file fails or gets corrupted.)

Refer to the corresponding sections for details on these utilities.



Save a copy of the original motherboard BIOS file to a bootable floppy disk or USB flash disk in case you need to restore the BIOS in the future. Copy the original motherboard BIOS using the ASUS Update or AFUDOS utilities.

5.1.1 ASUS Update utility

The ASUS Update is a utility that allows you to manage, save, and update the motherboard BIOS in Windows® environment. The ASUS Update utility allows you to:

- Save the current BIOS file
- Download the latest BIOS file from the Internet
- Update the BIOS from an updated BIOS file
- Update the BIOS directly from the Internet, and
- View the BIOS version information.

This utility is available in the support DVD that comes with the motherboard package.



ASUS Update requires an Internet connection either through a network or an Internet Service Provider (ISP).

Installing ASUS Update

To install ASUS Update:

1. Place the support DVD in the optical drive. The Drivers menu appears.
2. Click the **Utilities** tab, then click **Install ASUS Update**.
3. The ASUS Update utility is copied to your system.



Quit all Windows® applications before you update the BIOS using this utility.

Updating the BIOS through the Internet

To update the BIOS through the Internet:

1. Launch the ASUS Update utility from the Windows® desktop by clicking **Start > Programs > ASUS > ASUSUpdate > ASUSUpdate**. The ASUS Update main window appears.

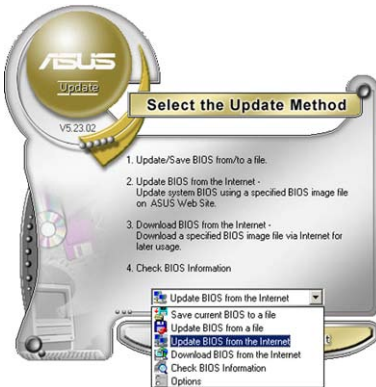
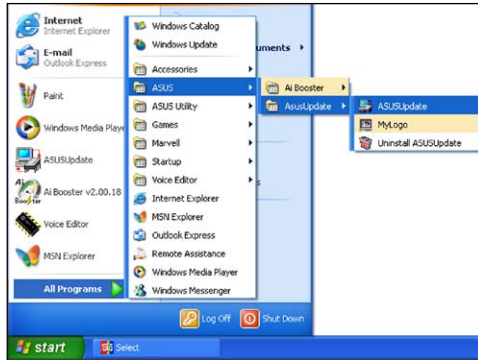

2. Select **Update BIOS** from the Internet option from the drop-down menu, then click **Next**.
3. Select the ASUS FTP site nearest you to avoid network traffic, or click **Auto Select**. Click **Next**.

4. From the FTP site, select the BIOS version that you wish to download. Click **Next**.
5. Follow the screen instructions to complete the update process.



The ASUS Update utility is capable of updating itself through the Internet. Always update the utility to avail all its features.



Updating the BIOS through a BIOS file

To update the BIOS through a BIOS file:

1. Launch the ASUS Update utility from the Windows® desktop by clicking **Start > Programs > ASUS > ASUSUpdate > ASUSUpdate**. The ASUS Update main window appears.
2. Select Update BIOS from a file option from the drop-down menu, then click **Next**.

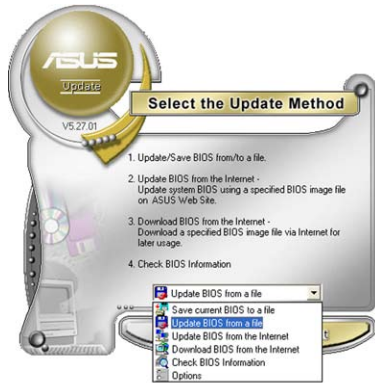

3. Locate the BIOS file from the Open window, then click **Open**.
4. Follow the screen instructions to complete the update process.

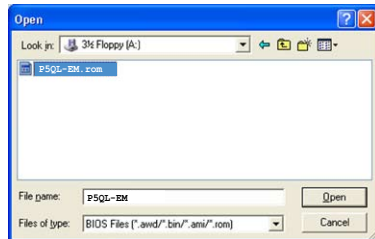

5.1.2 Creating a bootable floppy disk

1. Do either one of the following to create a bootable floppy disk.

DOS environment

- a. Insert a 1.44MB floppy disk into the drive.
- b. At the DOS prompt, type *format a: /s* then press <Enter>.

Windows® XP environment

- a. Insert a 1.44 MB floppy disk to the floppy disk drive.
- b. Click **Start** from the Windows® desktop, then select **My Computer**.
- c. Select the 3 1/2 Floppy Drive icon.
- d. Click File from the menu, then select **Format**. A **Format 3 1/2 Floppy Disk** window appears.
- e. Select **Create an MS-DOS startup disk** from the format options field, then click **Start**.

Windows® Vista environment

- a. Insert a formatted, high density 1.44 MB floppy disk to the floppy disk drive.
 - b. Click  from the Windows® desktop, then select **Computer**.
 - c. Right-click Floppy Disk Drive then click **Format** to display the Format 3 1/2 Floppy dialog box.
 - d. Select the **Create an MS-DOS startup disk** check box.
 - e. Click **Start**.
2. Copy the original or the latest motherboard BIOS file to the bootable floppy disk.

5.1.3 ASUS EZ Flash 2 utility

The ASUS EZ Flash 2 feature allows you to update the BIOS without having to go through the long process of booting from a floppy disk and using a DOS-based utility. The EZ Flash 2 utility is built-in the BIOS chip so it is accessible by pressing <Alt> + <F2> during the Power-On Self Tests (POST).

To update the BIOS using EZ Flash 2:

1. Visit the ASUS website (www.asus.com) to download the latest BIOS file for the motherboard.
2. Save the BIOS file to a floppy disk or a USB flash disk, then restart the system.
3. You can launch the EZ Flash 2 by two methods.
 - (1) Insert the floppy disk / USB flash disk that contains the BIOS file to the floppy disk drive or the USB port.

Press <Alt> + <F2> during POST to display the following.

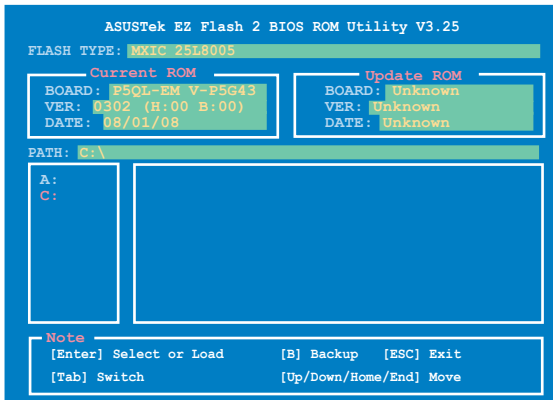

- (2) Enter BIOS setup program. Go to the **Tools** menu to select **EZ Flash2** and press <Enter> to enable it.

You can switch between drives by pressing <Tab> before the correct file is found. Then press <Enter>.
4. When the correct BIOS file is found, EZ Flash 2 performs the BIOS update process and automatically reboots the system when done.



- This function can support devices such as USB flash disk, or floppy disk with **FAT 32/16** format and single partition only.
- Do not shut down or reset the system while updating the BIOS to prevent system boot failure!

5.1.4 AFUDOS utility

The AFUDOS utility allows you to update the BIOS file in DOS environment using a bootable floppy disk with the updated BIOS file. This utility also allows you to copy the current BIOS file that you can use as backup when the BIOS fails or gets corrupted during the updating process.

Copying the current BIOS

To copy the current BIOS file using the AFUDOS utility:



- Make sure that the floppy disk is not write-protected and has at least 1024KB free space to save the file.
- The succeeding BIOS screens are for reference only. The actual BIOS screen displays may not be same as shown.

1. Copy the AFUDOS utility (afudos.exe) from the motherboard support DVD to the bootable floppy disk you created earlier.
2. Boot the system in DOS mode, then at the prompt type:

```
afudos /o[filename]
```

where the [filename] is any user-assigned filename not more than eight alphanumeric characters for the main filename and three alphanumeric characters for the extension name.

```
A:\>afudos /oOLDBIOS1.rom
```

Main filename Extension name

3. Press <Enter>. The utility copies the current BIOS file to the floppy disk.

```
A:\>afudos /oOLDBIOS1.rom
AMI Firmware Update Utility - Version 1.19 (ASUS V2.07 (03.11.24BB))
Copyright (C) 2002 American Megatrends, Inc. All rights reserved.
  Reading flash ..... done
  Write to file..... ok
A:\>
```

The utility returns to the DOS prompt after copying the current BIOS file.

Updating the BIOS file

To update the BIOS file using the AFUDOS utility:

1. Visit the ASUS website (www.asus.com) and download the latest BIOS file for the motherboard. Save the BIOS file to a bootable floppy disk.



Write the BIOS filename on a piece of paper. You need to type the exact BIOS filename at the DOS prompt.

2. Copy the AFUDOS utility (afudos.exe) from the motherboard support DVD to the bootable floppy disk you created earlier.
3. Boot the system in DOS mode, then at the prompt type:
afudos /i [filename]

where [filename] is the latest or the original BIOS file on the bootable floppy disk.

```
A:\>afudos /iP5QLEM.ROM
```

4. The utility verifies the file and starts updating the BIOS.

```
A:\>afudos /iP5QLEM.ROM
AMI Firmware Update Utility - Version 1.19(ASUS V2.07(03.11.24BB))
Copyright (C) 2002 American Megatrends, Inc. All rights reserved.

WARNING!! Do not turn off power during flash BIOS
Reading file ..... done
Reading flash ..... done

Advance Check .....
Erasing flash ..... done
Writing flash ..... 0x0008CC00 (9%)
```



Do not shut down or reset the system while updating the BIOS to prevent system boot failure!

5. The utility returns to the DOS prompt after the BIOS update process is completed. Reboot the system from the hard disk drive.

```
A:\>afudos /iP5QLEM.ROM
AMI Firmware Update Utility - Version 1.19(ASUS V2.07(03.11.24BB))
Copyright (C) 2002 American Megatrends, Inc. All rights reserved.

WARNING!! Do not turn off power during flash BIOS
Reading file ..... done
Reading flash ..... done

Advance Check .....
Erasing flash ..... done
Writing flash ..... done
Verifying flash .... done

Please restart your computer

A:\>
```

5.1.5 ASUS CrashFree BIOS 3 utility

The ASUS CrashFree BIOS 3 is an auto recovery tool that allows you to restore the BIOS file when it fails or gets corrupted during the updating process. You can update a corrupted BIOS file using the motherboard support DVD, the floppy disk, or the USB flash disk that contains the updated BIOS file.



- Prepare the motherboard support DVD, the floppy disk or the USB flash disk containing the updated motherboard BIOS before using this utility.
- If you use a SATA optical drive, always connect the SATA cable to the SATA1/SATA2 connector; otherwise, the utility will not function.

Recovering the BIOS from the support DVD

To recover the BIOS from the support DVD:

1. Turn on the system.
2. Insert the motherboard support DVD to the optical drive.
3. The utility displays the following message and automatically checks the DVD for the BIOS file.

```
Bad BIOS checksum. Starting BIOS recovery...
Checking for floppy...
```

When found, the utility reads the BIOS file and starts flashing the corrupted BIOS file.

```
Bad BIOS checksum. Starting BIOS recovery...
Checking for floppy...
Floppy found!
Reading file "P5QLEM.ROM". Completed.
Start flashing...
```

4. Restart the system after the utility completes the updating process.

Recovering the BIOS from the USB flash disk

To recover the BIOS from the USB flash disk:

1. Insert the USB flash disk that contains BIOS file to the USB port.
2. Turn on the system.
3. The utility will automatically checks the devices for the BIOS file. When found, the utility reads the BIOS file and starts flashing the corrupted BIOS file.
4. Restart the system after the utility completes the updating process.



- Only the USB flash disk with FAT 32/16 format and single partition can support ASUS CrashFree BIOS 3. The device size should be smaller than 8GB.
- DO NOT shut down or reset the system while updating the BIOS! Doing so can cause system boot failure!

5.2 BIOS setup program

This motherboard supports a programmable Serial Peripheral Interface (SPI) chip that you can update using the provided utility described in section “5.1 Managing and updating your BIOS.”

Use the BIOS Setup program when you are installing a motherboard, reconfiguring your system, or prompted to “Run Setup.” This section explains how to configure your system using this utility.

Even if you are not prompted to use the Setup program, you can change the configuration of your computer in the future. For example, you can enable the security password feature or change the power management settings. This requires you to reconfigure your system using the BIOS Setup program so that the computer can recognize these changes and record them in the CMOS RAM of the SPI chip.

The SPI chip on the motherboard stores the Setup utility. When you start up the computer, the system provides you with the opportunity to run this program. Press during the Power-On Self-Test (POST) to enter the Setup utility; otherwise, POST continues with its test routines.

If you wish to enter Setup after POST, restart the system by pressing <Ctrl+Alt+Delete>, or by pressing the reset button on the system chassis. You can also restart by turning the system off and then back on. Do this last option only if the first two failed.

The Setup program is designed to make it as easy to use as possible. Being a menu-driven program, it lets you scroll through the various sub-menus and make your selections from the available options using the navigation keys.



-
- The default BIOS settings for this motherboard apply for most conditions to ensure optimum performance. If the system becomes unstable after changing any BIOS settings, load the default settings to ensure system compatibility and stability. Select the **Load Setups Default** item under the Exit Menu. See section **5.8 Exit Menu**.
 - The BIOS setup screens shown in this section are for reference purposes only, and may not exactly match what you see on your screen.
 - Visit the ASUS website (www.asus.com) to download the latest BIOS file for this motherboard.
-

5.2.1 BIOS menu screen

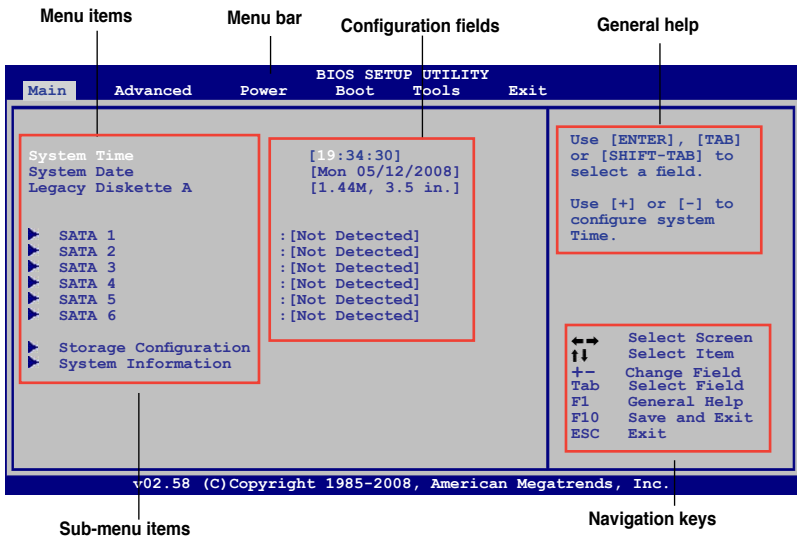

5.2.2 Menu bar

The menu bar on top of the screen has the following main items:

- Main** For changing the basic system configuration
- Advanced** For changing the advanced system settings
- Power** For changing the advanced power management (APM) configuration
- Boot** For changing the system boot configuration
- Tools** For Configuring options for special functions
- Exit** For selecting the exit options and loading default settings.

To select an item on the menu bar, press the right or left arrow key on the keyboard until the desired item is highlighted.

5.2.3 Navigation keys

At the bottom right corner of a menu screen are the navigation keys for that particular menu. Use the navigation keys to select items in the menu and change the settings.



Some of the navigation keys differ from one screen to another.

5.2.4 Menu items

The highlighted item on the menu bar displays the specific items for that menu. For example, selecting Main shows the Main menu items.

The other items (Advanced, Power, Boot, and Exit) on the menu bar have their respective menu items.

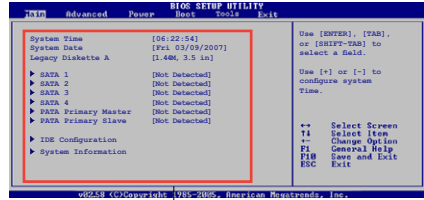

Main menu items

5.2.5 Sub-menu items

A solid triangle before each item on any menu screen means that the item has a sub-menu. To display the sub-menu, select the item and press <Enter>.

5.2.6 Configuration fields

These fields show the values for the menu items. If an item is user-configurable, you can change the value of the field opposite the item. You cannot select an item that is not user-configurable.

A configurable field is enclosed in brackets, and is highlighted when selected. To change the value of a field, select it then press <Enter> to display a list of options. Refer to “5.2.7 Pop-up window.”

5.2.7 Pop-up window

Select a menu item then press <Enter> to display a pop-up window with the configuration options for that item.

5.2.8 Scroll bar

A scroll bar appears on the right side of a menu screen when there are items that do not fit on the screen. Press the Up/Down arrow keys or <Page Up> /<Page Down> keys to display the other items on the screen.

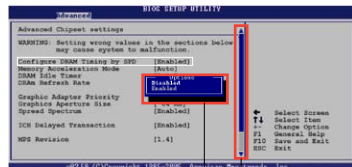

Pop-up window

Scroll bar

5.2.9 General help

At the top right corner of the menu screen is a brief description of the selected item.

5.3 Main menu

When you enter the BIOS Setup program, the Main menu screen appears, giving you an overview of the basic system information.



Refer to section **5.2.1 BIOS menu screen** for information on the menu screen items and how to navigate through them.

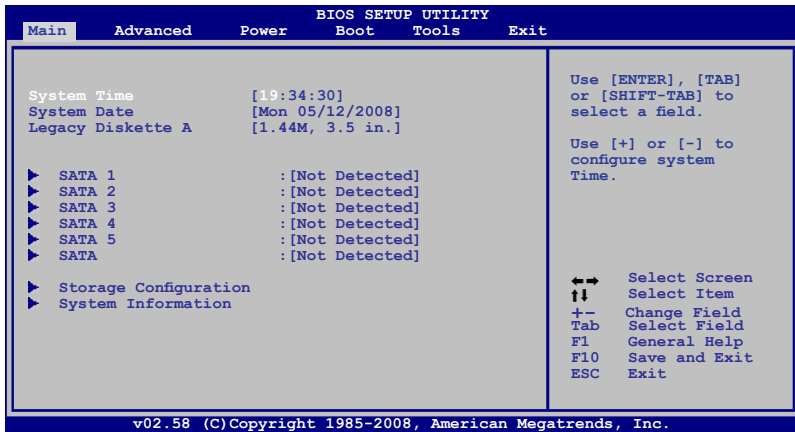

5.3.1 System Time [xx:xx:xx]

Allows you to set the system time.

5.3.2 System Date [Day xx/xx/xxxx]

Allows you to set the system date.

5.3.3 Legacy Diskette A [1.44M, 3.5 in.]

Sets the type of floppy drive installed.

Configuration options: [Disabled] [720K, 3.5 in.] [1.44M, 3.5 in.]

5.3.4 SATA 1~6

While entering Setup, the BIOS automatically detects the presence of IDE devices. There is a separate sub-menu for each IDE device. Select a device item then press <Enter> to display the IDE device information.

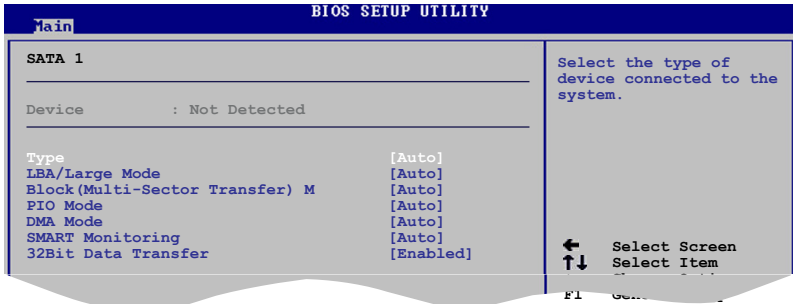

The BIOS automatically detects the values opposite the dimmed items (Device, Vendor, Size, LBA Mode, Block Mode, PIO Mode, Async DMA, Ultra DMA, and SMART monitoring). These values are not user-configurable. These items show N/A if no IDE device is installed in the system.

Type [Auto]

Selects the type of IDE drive. Setting to [Auto] allows automatic selection of the appropriate IDE device type. Select [CDROM] if you are specifically configuring a CD-ROM drive. Select [ARMD] (ATAPI Removable Media Device) if your device is either a ZIP, LS-120, or MO drive.

Configuration options: [Not Installed] [Auto] [CDROM] [ARMD]



This item does not appear when you select the **PATA Primary Master/Slave** device.

LBA/Large Mode [Auto]

Enables or disables the LBA mode. Setting to [Auto] enables the LBA mode if the device supports this mode, and if the device was not previously formatted with LBA mode disabled. Configuration options: [Disabled] [Auto]

Block (Multi-sector Transfer) [Auto]

Enables or disables data multi-sectors transfers. When set to [Auto], the data transfer from and to the device occurs multiple sectors at a time if the device supports multi-sector transfer feature. When set to [Disabled], the data transfer from and to the device occurs one sector at a time.

Configuration options: [Disabled] [Auto]

PIO Mode [Auto]

Selects the PIO mode.

Configuration options: [Auto] [0] [1] [2] [3] [4]

DMA Mode [Auto]

Selects the DMA mode. Configuration options: [Auto]

SMART Monitoring [Auto]

Sets the Smart Monitoring, Analysis, and Reporting Technology.

Configuration options: [Auto] [Disabled] [Enabled]

32Bit Data Transfer [Enabled]

Enables or disables 32-bit data transfer.

Configuration options: [Disabled] [Enabled]

5.3.5 Storage Configuration

The items in this menu allow you to set or change the configurations for the SATA devices installed in the system. Select an item then press **<Enter>** if you want to configure the item.

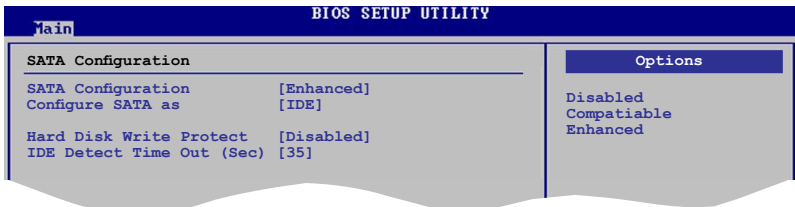

SATA Configuration [Enhanced]

Configuration options: [Disabled] [Compatible] [Enhanced]

Configure SATA As [IDE]

Sets the configuration for the Serial ATA connectors supported by the Southbridge chip.

The AHCI allows the onboard storage driver to enable advanced Serial ATA features that increases storage performance on random workloads by allowing the drive to internally optimize the order of commands.

If you want to use the Serial ATA hard disk drives as Parallel ATA physical storage devices, keep the default setting [IDE].

If you want the Serial ATA hard disk drives to use the Advanced Host Controller Interface (AHCI), set this item to [AHCI].

Hard Disk Write Protect [Disabled]

Disables or enables device write protection. This will be effective only if device is accessed through BIOS. Configuration option: [Disabled] [Enabled]

SATA Detect Time Out (Sec) [35]

Selects the time out value for detecting ATA/ATAPI devices.
Configuration options: [0] [5] [10] [15] [20] [25] [30] [35]

5.3.6 System Information

This menu gives you an overview of the general system specifications. The BIOS automatically detects the items in this menu.

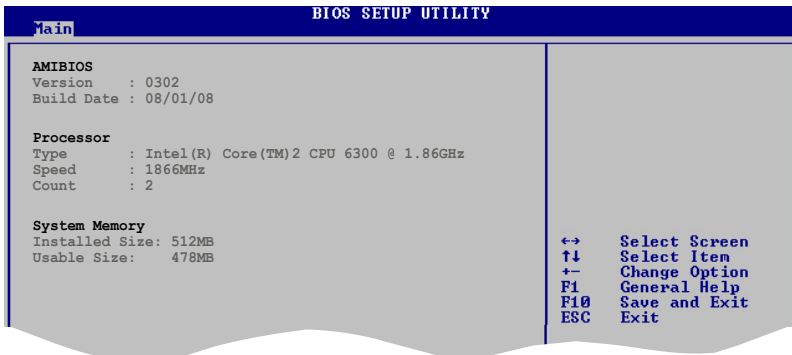

AMI BIOS

Displays the auto-detected BIOS information.

Processor

Displays the auto-detected CPU specification.

System Memory

Displays the auto-detected system memory.

5.4 Advanced menu

The Advanced menu items allow you to change the settings for the CPU and other system devices.



Take caution when changing the settings of the Advanced menu items. Incorrect field values can cause the system to malfunction.

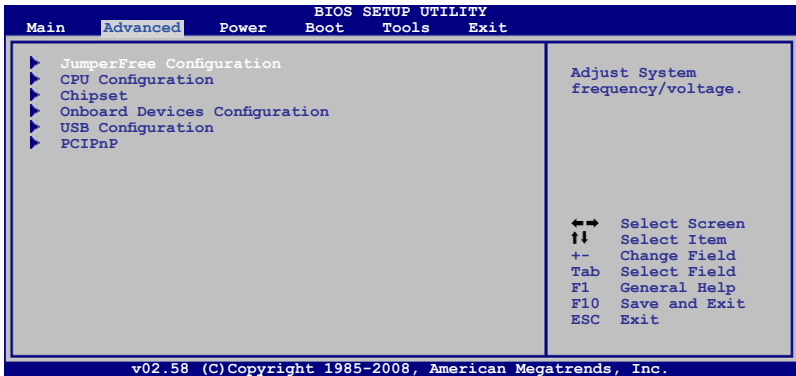

5.4.1 Jumperfree Configuration

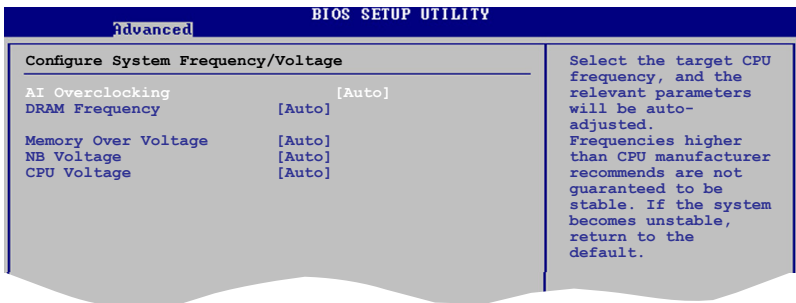

AI Overclocking [Auto]

Allows selection of CPU overclocking options to achieve desired CPU internal frequency. Select either one of the preset overclocking configuration options:

Manual - allows you to individually set overclocking parameters.

Auto - loads the optimal settings for the system.

Overclock Profile - loads overclocking profiles with optimal parameters for stability when overclocking.



The following item appears only when you set the **AI Overclocking** item to **[Manual]**.

CPU Frequency [xxx]

Displays the frequency sent by the clock generator to the system bus and PCI bus. The value of this item is auto-detected by the BIOS. Use the <+> and <-> keys to adjust the CPU frequency. You can also type the desired CPU frequency using the numeric keypad. The values range from 200 to 600. Refer to the table below for the correct Front Side Bus and CPU External Frequency settings.

FSB / CPU External Frequency Synchronization

Front Side Bus	CPU External Frequency
FSB 1333	333 MHz
FSB 1066	266 MHz
FSB 800	200 MHz



The following item appears only when you set the AI Overclocking item to **[Overclock Profile]**.

Overclock Options [Overclock 5%]

Allows you to select the overclock options. Configuration options: [Overclock 5%] [Overclock 10%] [Overclock 15%] [Overclock 20%] [Overclock 30%]

DRAM Frequency [Auto]

Allows you to set the DDR2 operating frequency. Configuration options: [Auto] [667 MHz] [800 MHz] [1067MHz]



The following table shows the DRAM Frequency options that appear when the FSB value is 1333, 1066, and 800.

FSB	DRAM Frequency							
	Auto	667MHz	800MHz	960MHz	1000MHz	1067MHz	1100MHz	1200MHz
1333	v	v	v		v		v	
1066	v	v	v			v		
800	v	v	v					



Selecting a very high DRAM frequency may cause the system to become unstable! If this happens, revert to the default setting.

Memory Over Voltage [Auto]

Allows you to adjust Memory Over voltage and each step is 6.25mV

NB Voltage [Auto]

Allows you to set the NB voltage. Configuration options: [Auto] [1.1V] [1.198V] [1.3V] [1.388V]



Setting a very high voltage may damage the component permanently, and setting a very low voltage may cause the system to become unstable.

CPU Voltage [Auto]

Allows you to set the CPU VCore voltage. The values range from 0.8500V to 1.55V with a 0.00625V interval. Configuration options: [Auto]



Setting a very high voltage may damage the component permanently, and setting a very low voltage may cause the system to become unstable.

5.4.2 CPU Configuration

The items in this menu show the CPU-related information that the BIOS automatically detects.

The screenshot shows the BIOS Setup Utility interface. At the top, it says "BIOS SETUP UTILITY" and "Advanced" is selected. The main menu is "Configure advanced CPU settings" with a sub-menu "Module version: 3D.06". The CPU information is displayed as follows:

Manufacturer:	Intel
Brand String:	Intel(R) Core(TM)2 CPU 6300 @ 1.86GHz
Frequency:	1.86GHz
FSB Speed:	1066MHz
Cache L1:	64 KB
Cache L2:	2048 KB
Ratio Status:	Unlocked (Max:07.0, Min:06.0)
Ratio Actual Value:	7
CPUID:	6F2

Below this, the CPU Ratio Setting is set to [Auto]. Other options include C1E Support [Enabled], Max CPUID Value Limit [Disabled], Vanderpool Technology [Enabled], CPU TM function [Enabled], Execute Disable Bit [Enabled], and Intel(R) SpeedStep(TM) Tech. [Enabled].

On the right side of the screen, there is a note: "Sets the ratio between CPU Core Clock and the FSB Frequency. NOTE: If an invalid ratio is set in CMOS then actual and setpoint values may differ. NOTE: Please Key in ratio numbers directly!"

At the bottom right, there is a legend for navigation keys:

↔	Select Screen
↑↓	Select Item
+ -	Change Option
F1	General Help
F10	Save and Exit
ESC	Exit

CPU Ratio Setting [Auto]

Sets the ratio between CPU Core Clock and the FSB frequency. Configuration options: [Auto].



If an invalid ratio is set in CMOS then actual and setpoint values may differ.



Key in ratio numbers directly.

C1E Support [Enabled]

Allows you to enable or disable Inter CPU Enhanced Halt (C1E) function, a CPU power-saving function in system halt state. When enabled, the CPU core frequency and voltage will be reduced during the system halt state to decrease power consumption. Configuration options: [Disabled] [Enabled]

Max CPUID Value Limit [Disabled]

Allows you to determine whether to limit CPUID maximum value. Set this item to **[Disabled]** for Windows XP operating system; set this item to **[Enabled]** for legacy operating system such as Windows NT4.0. (Default: Disabled)
Configuration options: [Disabled] [Enabled]

Vanderpool Technology [Enabled]

Enables or disables Intel® Virtualization Technology. Virtualization enhanced by Intel® Virtualization Technology allows a platform to run multiple operating systems and applications in independent partitions. With virtualization, one computer system can function as multiple virtual systems. Configuration options: [Enabled] [Disabled]

CPU TM function [Enabled]

Enables or disables Intel® CPU Thermal Monitor (TM) function, a CPU overheating protection function. When enabled, the CPU core frequency and voltage are reduced when the CPU overheats. Configuration options: [Disabled] [Enabled]

Execute Disable Bit [Enabled]

Enables or disables Intel® Execute Disable Bit function. This function enhances protection of your computer, reducing exposure to viruses and malicious buffer overflow attacks when working with its supporting software and system. Configuration options: [Disabled] [Enabled]



The following item appears only when you installed an Intel® Pentium® 4 or later CPU that supports the Enhanced Intel SpeedStep® Technology (EIST).

Intel® SpeedStep™ Technology [Enabled]

Allows you to use the Enhanced Intel® SpeedStep® Technology. When set to **[Enabled]**, you can adjust the system power settings in the operating system to use the EIST feature. Set this item to **[Disabled]** if you do not want to use the EIST. Configuration options: [Enabled] [Disabled]

5.4.3 Chipset

The Chipset menu allows you to change the advanced chipset settings. Select an item then press <Enter> to display the sub-menu.

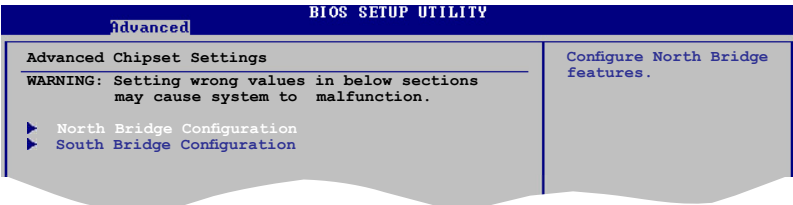

North Bridge Configuration

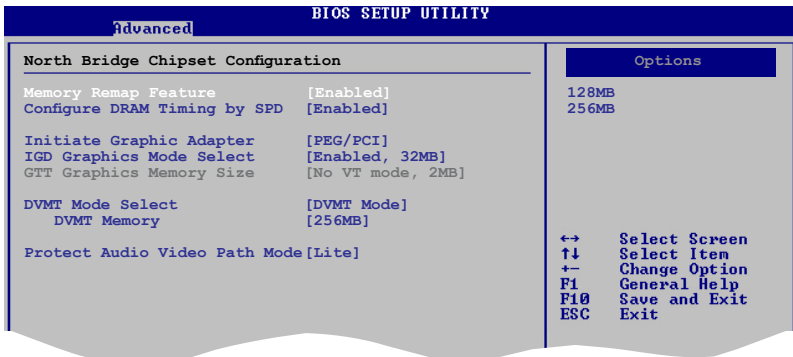

Memory Remap Feature [Disabled]

Allows you to enable or disable the remapping of overlapped PCI memory above the total physical memory. We recommend that you set this item to **Enabled** when you install 4GB memory. Configuration options: [Enabled] [Disabled]

Configure DRAM Timing by SPD [Enabled]

Allows you to enable or disable configuring DRAM Timing by SPD. Configuration options: [Enabled] [Disabled]

Initiate Graphic Adapter [PEG/PCI]

Allows you to select the graphics controller as the primary boot device.
Configuration options: [IGD] [PCI/IGD] [PCI/PEG] [PEG/IGD][PEG/PCI]

IGD Graphics Mode Select [Enabled, 32MB]

Sets the IGD graphics mode.
Configuration options: [Disabled] [Enabled, 32MB] [Enabled, 64MB] [Enabled, 128MB]

DVMT Mode Select [DVMT Mode]

Allows you to select the graphics memory type.
Configuration options: [DVMT Mode]

DVMT Memory [256MB]
Configuration options: [128MB] [256MB] [Maximum DVMT]



This option only appears when installing 1GB DDR2 DIMMs into the DIMM sockets.

Protect Audio Video Path Mode [Lite]

Allows you to set PAVP mode.
Configuration options: [Disabled] [Lite] [Paranoid]

To use the High-Bandwidth Digital Content Protection (HDCP) function, set this option to either **[Lite]** or **[Paranoid]**. If you select Paranoid Mode, the system reserves 96MB for playing and storing the decrypted contents. The operation system and other programs cannot use this reserved memory, and Vista Aero (DWM) is disabled.

Feature	PAVP Lite	PAVP Paranoid
Compressed video buffer is encrypted	Yes	Yes
HW 128-bit AES decryption	Yes	Yes
Protected memory (96MB reserved during boot)	No	Yes

South Bridge Configuration

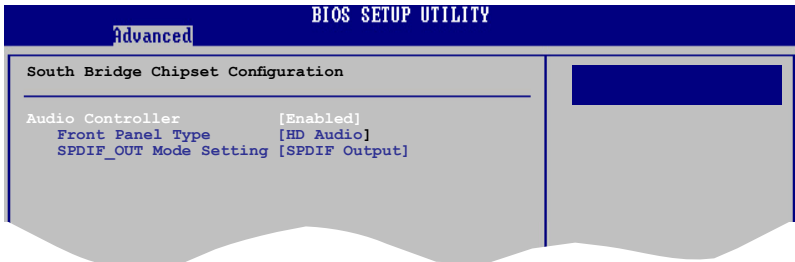

Audio Controller [Enabled]

Allows you to set the audio controller. Configuration options: [Enabled] [Disabled]

Front Panel Support Type [HD Audio]

Allows you to select the front panel support type. If High Definition Audio Front Panel used, please set HD Audio mode. Configuration options: [AC97] [HD Audio]

SPDIF_OUT Mode Setting [SPDIF Output]

Allows you to select SPDIF_OUT mode setting. Configuration options: [HDMI Output] [SPDIF Output]

5.4.4 Onboard Devices Configuration

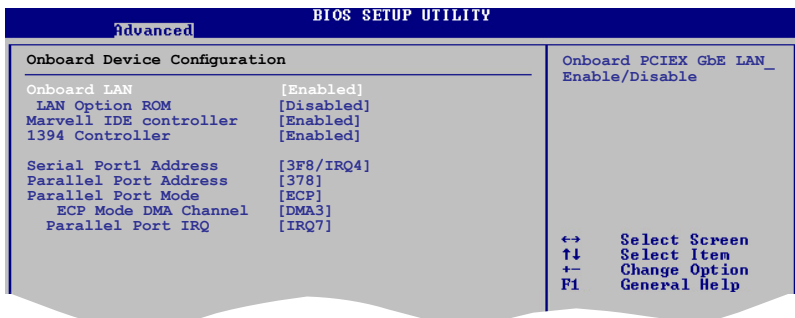

Onboard LAN [Enabled]

Allows you to enable or disable the onboard LAN controller.

Configuration options: [Enabled] [Disabled]

LAN Option ROM [Disabled]

Allows you to enable or disable the LAN option ROM in the onboard LAN controller. This item appears only when the Onboard LAN item is set to Enabled. Configuration options: [Disabled] [Enabled]

Marvell IDE controller [Enabled]

Allows you to enable or disable Marvell IDE controller.

Configuration options: [Enabled] [Disabled]

1394 controller [Enabled]

Allows you to enable or disable 1394 controller.

Configuration options: [Enabled] [Disabled]

Serial Port1 Address [3F8/IRQ4]

Allows you to select the Serial Port1 base address.

Configuration options: [Disabled] [3F8/IRQ4] [2F8/IRQ3] [3E8/IRQ4] [2E8/IRQ3]

Parallel Port Address [378]

Allows you to select the Parallel Port base addresses. Configuration options: [Disabled] [378] [278] [3BC]

Parallel Port Mode [ECP]

Allows you to select the Parallel Port mode. Configuration options: [Normal] [Bi-Directional] [EPP] [ECP]

ECP Mode DMA Channel [DMA3]

Appears only when the Parallel Port Mode is set to [ECP]. This item allows you to set the Parallel Port ECP DMA. Configuration options: [DMA0] [DMA1] [DMA3]

Parallel Port IRQ [IRQ7]

Allows you to select parallel port IRQ. Configuration options: [IRQ5] [IRQ7]

5.4.5 USB Configuration

The items in this menu allows you to change the USB-related features. Select an item then press <Enter> to display the configuration options.

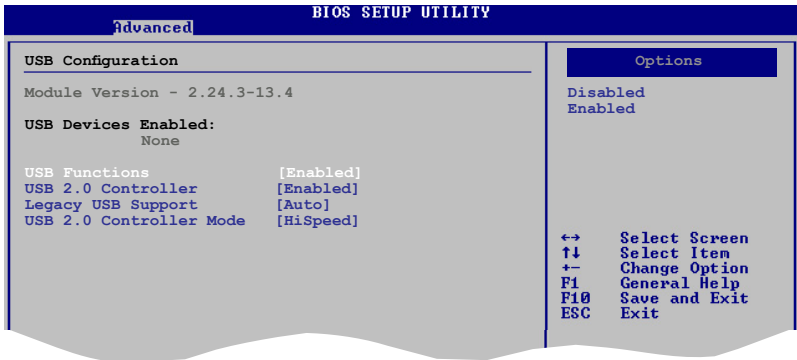

The Module Version and USB Devices Enabled items show the auto-detected values. If no USB device is detected, the item shows **None**.

USB Functions [Enabled]

Allows you to disable or select the different values of the USB functions.
Configuration options: [Disabled] [Enabled]

USB 2.0 Controller [Enabled]

Allows you to enable or disable USB 2.0 controller.
Configuration options: [Enabled] [Disabled]

Legacy USB Support [Auto]

Allows you to enable or disable support for Legacy USB storage devices, including USB flash drives and USB hard drives. Setting to **[Auto]** allows the system to detect the presence of USB devices at startup. If detected, the USB controller legacy mode is enabled. If no USB device is detected, the legacy USB support is disabled. Configuration options: [Disabled] [Enabled] [Auto]

USB 2.0 Controller Mode [HiSpeed]

Allows you to configure the USB 2.0 controller in HiSpeed (480 Mbps) or Full Speed (12 Mbps). Configuration options: [FullSpeed] [HiSpeed]

5.4.6 PCI PnP

The PCI PnP menu items allow you to change the advanced settings for PCI/PnP devices. The menu includes setting IRQ and DMA channel resources for either PCI/PnP or legacy ISA devices, and setting the memory size block for legacy ISA devices.



Take caution when changing the settings of the PCI PnP menu items. Incorrect field values can cause the system to malfunction.

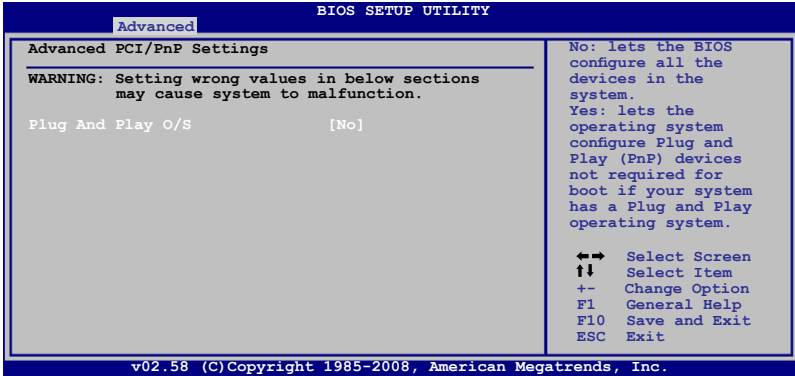

Plug and Play O/S [No]

When set to [No], BIOS configures all the devices in the system. When set to [Yes] and if you install a Plug and Play operating system, the operating system configures the Plug and Play devices not required for boot. Configuration options: [No] [Yes]

5.5 Power menu

The Power menu items allow you to change the settings for the Advanced Power Management (APM). Select an item then press <Enter> to display the configuration options.

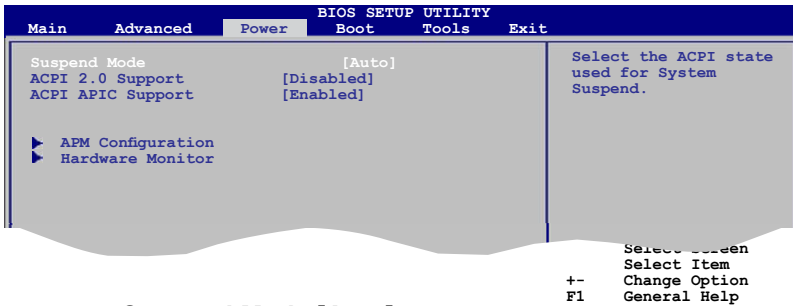

5.5.1 Suspend Mode [Auto]

Allows you to select the Advanced Configuration and Power Interface (ACPI) state to be used for system suspend. Configuration options: [S1 (POS) Only] [S3 Only] [Auto]

[S1(POS) Only] - Enables the system to enter the ACPI S1 (Power on Suspend) sleep state. In S1 sleep state, the system appears suspended and stays in a low power mode. The system can be resumed at any time.

[S3 Only] - Enables the system to enter the ACPI S3 (Suspend to RAM) sleep state (default). In S3 sleep state, the system appears to be off and consumes less power than in the S1 state. When signaled by a wake-up device or event, the system resumes to its working state exactly where it was left off.

[Auto] - Detected by OS.

5.5.2 ACPI 2.0 Support [Disabled]

Allows you to add more tables for Advanced Configuration and Power Interface (ACPI) 2.0 specifications. Configuration options: [Disabled] [Enabled]

5.5.3 ACPI APIC Support [Enabled]

Allows you to enable or disable the Advanced Configuration and Power Interface (ACPI) support in the Application-Specific Integrated Circuit (ASIC). When set to Enabled, the ACPI APIC table pointer is included in the RSDT pointer list. Configuration options: [Disabled] [Enabled]

5.5.4 APM Configuration

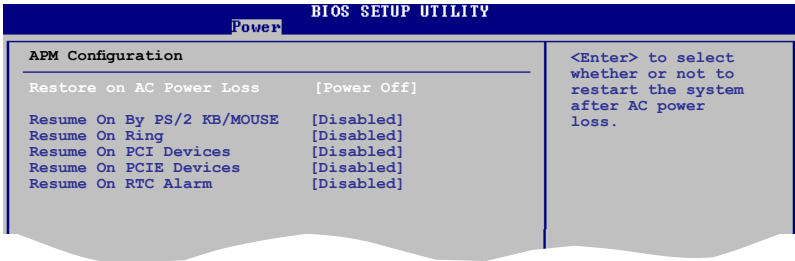

Restore on AC Power Loss [Power Off]

When set to **[Power Off]**, the system goes into off state after an AC power loss. When set to **[Power On]**, the system goes on after an AC power loss. When set to **[Last State]**, the system goes into either off or on state, whatever the system state was before the AC power loss. Configuration options: [Power Off] [Power On] [Last State]

Power On By PS/2 KB/Mouse [Disabled]

When set to [Enabled], this parameter allows you to use the PS/2 KB/mouse to turn on the system. This feature requires an ATX power supply that provides at least 1A on the +5VSB lead. Configuration options: [Disabled] [Enabled]

Resume On Ring [Disabled]

Allows you to enable or disable RI to generate a wake event. Configuration options: [Disabled] [Enabled]

Resume On PCI Devices [Disabled]

When set to [Enabled], this parameter allows you to wake the system through a PCI LAN or modem card. This feature requires an ATX power supply that provides at least 1A on the +5VSB lead. Configuration options: [Disabled] [Enabled]

Resume On PCIE Devices [Disabled]

When set to [Enabled], this parameter allows you to wake the system through a PCI Express card. This feature requires an ATX power supply that provides at least 1A on the +5VSB lead. Configuration options: [Disabled] [Enabled]

Resume On RTC Alarm [Disabled]

Allows you to enable or disable RTC to generate a wake event. When this item is set to Enabled, the items RTC Alarm Date, RTC Alarm Hour, RTC Alarm Minute, and RTC Alarm Second appear with set values. Configuration options: [Disabled] [Enabled]

5.5.5 Hardware Monitor

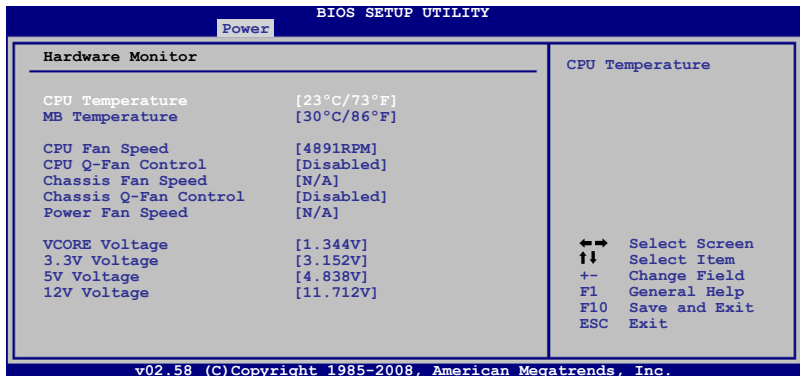

CPU Temperature [xxx°C/xxx°F] or [Ignored]

MB Temperature [xxx°C/xxx°F] or [Ignored]

The onboard hardware monitor automatically detects and displays the motherboard and CPU temperatures. Select **Ignored** if you do not wish to display the detected temperatures.

CPU Fan Speed (RPM) [xxxxRPM] or [Ignored]

The onboard hardware monitor automatically detects and displays the CPU fan speed in rotations per minute (RPM). If the fan is not connected to the motherboard, the field shows **N/A**. Select Ignored if you do not wish to display the detected speed.

CPU Q-Fan Control [Disabled]

Allows you to enable or disable the Q-Fan control. Configuration options: [Disabled] [Enabled]

Chassis Fan Speed [Ignored] or [N/A]

The onboard hardware monitor automatically detects and displays the Chassis fan speed in rotations per minute (RPM). If the fan is not connected to the motherboard, the field shows **N/A**. Select Ignored if you do not wish to display the detected speed.

Chassis Q-Fan Control [Disabled]

Allows you to enable or disable the Chassis Q-Fan control. Configuration options: [Disabled] [Enabled]

Power Fan Speed [Ignored] or [N/A]

The onboard hardware monitor automatically detects and displays the Power fan speed in rotations per minute (RPM). If the fan is not connected to the motherboard, the field shows **N/A**. Select Ignored if you do not wish to display the detected speed.

VCORE Voltage, 3.3V Voltage, 5V Voltage, 12V Voltage [xxxV] or [Ignored]

The onboard hardware monitor automatically detects the voltage output through the onboard voltage regulators.

5.6 Boot menu

The Boot menu items allow you to change the system boot options. Select an item then press **<Enter>** to display the sub-menu.

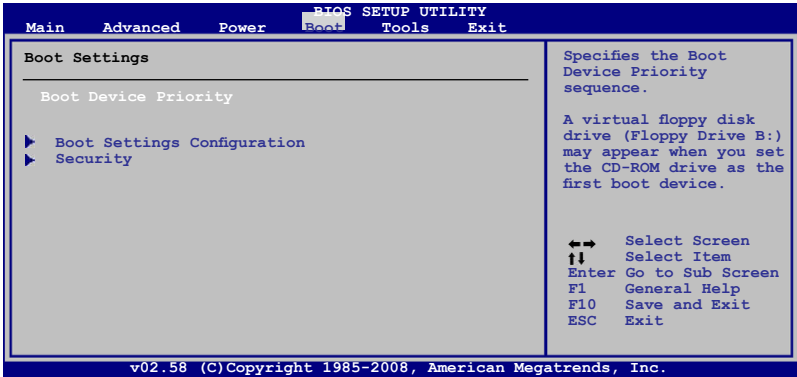

5.6.1 Boot Device Priority

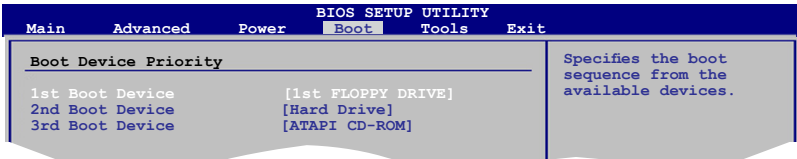

1st ~ xxth Boot Device [XX Drive]

These items specify the boot device priority sequence from the available devices. The number of device items that appears on the screen depends on the number of devices installed in the system. Configuration options: [xx Drive] [Disabled]

5.6.2 Boot Settings Configuration

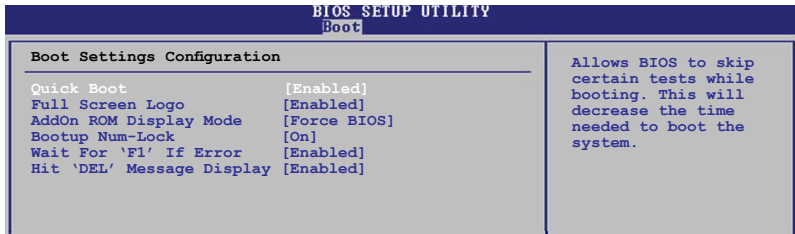

Quick Boot [Enabled]

Enabling this item allows the BIOS to skip some power on self tests (POST) while booting to decrease the time needed to boot the system. When set to [Disabled], BIOS performs all the POST items. Configuration options: [Disabled] [Enabled]

Full Screen Logo [Enabled]

This allows you to enable or disable the full screen logo display feature. Configuration options: [Disabled] [Enabled]



Set this item to **[Enabled]** to use the ASUS MyLogo2™ feature.

AddOn ROM Display Mode [Force BIOS]

Allows you to set display mode for Option ROM. Configuration options: [Force BIOS] [Keep Current]

Bootup Num-Lock [On]

Allows you to select the power-on state for the NumLock. Configuration options: [Off] [On]

Wait for 'F1' If Error [Enabled]

When set to Enabled, the system waits for the **F1** key to be pressed when error occurs. Configuration options: [Disabled] [Enabled]

Hit 'DEL' Message Display [Enabled]

When set to Enabled, the system displays the message "**Press DEL to run Setup**" during POST. Configuration options: [Disabled] [Enabled]

5.6.3 Security

The Security menu items allow you to change the system security settings. Select an item then press **<Enter>** to display the configuration options.

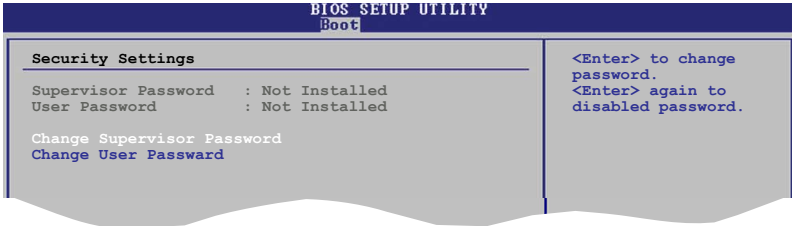

Change Supervisor Password

Select this item to set or change the supervisor password. The **Supervisor Password** item on top of the screen shows the default **Not Installed**. After you set a password, this item shows **Installed**.

To set a Supervisor Password:

1. Select the **Change Supervisor Password** item and press **<Enter>**.
2. From the password box, type a password composed of at least six letters and/or numbers, then press **<Enter>**.
3. Confirm the password when prompted.

The message **"Password Installed"** appears after you successfully set your password.

To change the supervisor password, follow the same steps as in setting a supervisor password.

To clear the supervisor password, select the **Change Supervisor Password** then press **<Enter>**. The message **"Password uninstalled"** appears.



If you forget your BIOS password, you can clear it by erasing the CMOS Real Time Clock (RTC) RAM. See section "4.6 Jumpers" for information on how to erase the RTC RAM.

After you have set a supervisor password, the other items appear to allow you to change other security settings.

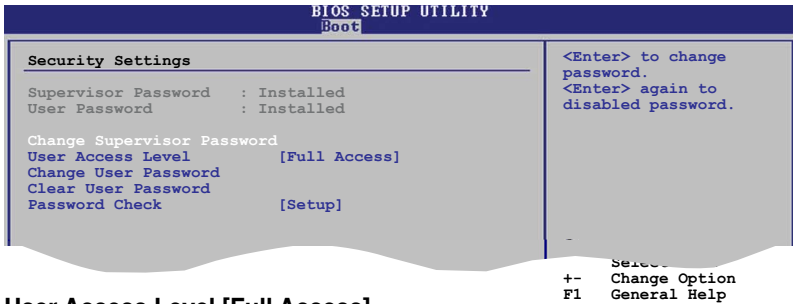

User Access Level [Full Access]

This item allows you to select the access restriction to the Setup items.
Configuration options: [No Access] [View Only] [Limited] [Full Access]

No Access prevents user access to the Setup utility.

View Only allows access but does not allow change to any field.

Limited allows changes only to selected fields, such as Date and Time.

Full Access allows viewing and changing all the fields in the Setup utility.

Change User Password

Select this item to set or change the user password. The **User Password** item on top of the screen shows the default **Not Installed**. After you set a password, this item shows **Installed**.

To set a User Password:

1. Select the **Change User Password** item and press **<Enter>**.
2. On the password box that appears, type a password composed of at least six letters and/or numbers, then press **<Enter>**.
3. Confirm the password when prompted.

The message “**Password Installed**” appears after you set your password successfully.

To change the user password, follow the same steps as in setting a user password.

Clear User Password

Select this item to clear the user password.

Password Check [Setup]

When set to **[Setup]**, BIOS checks for user password when accessing the Setup utility. When set to **[Always]**, BIOS checks for user password both when accessing Setup and booting the system. Configuration options: [Setup] [Always]

5.7 Tools menu

The Tools menu items allow you to launch special functions. Select an item then press **<Enter>** to display the sub-menu.

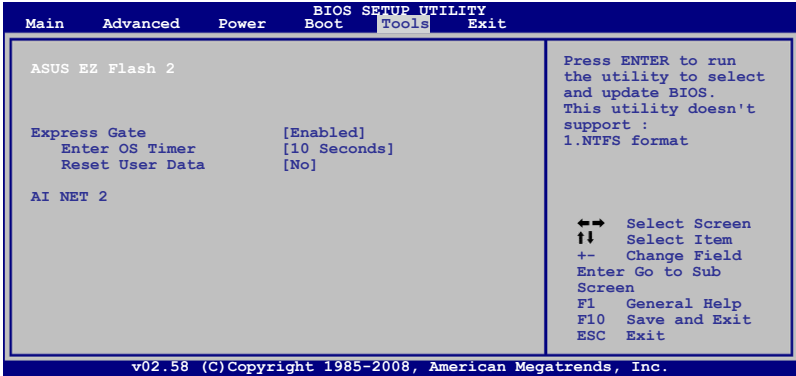

5.7.1 ASUS EZ Flash 2

Allows you to run ASUS EZ Flash 2. When you press **<Enter>**, a confirmation message appears. Use the left/right arrow key to select between **[Yes]** or **[No]**, then press **<Enter>** to confirm your choice.

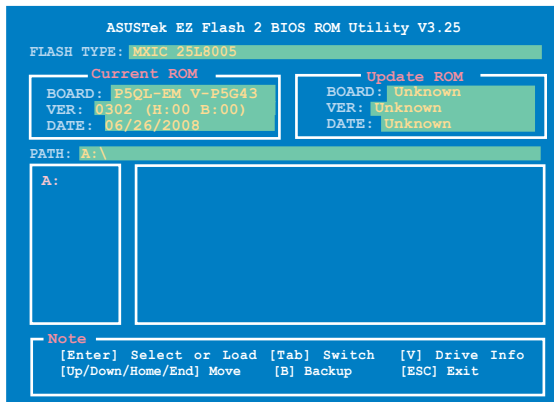

This function only supports FAT 32/16 format.

5.7.2 Express Gate [Enabled]

Allows you to enable or disable the ASUS Express Gate feature. The ASUS Express Gate feature is a unique instant-on environment that provides quick access to the Internet browser and Skype. Configuration options: [Enabled] [Disabled]

Enter OS Timer [10 Seconds]

Sets countdown duration that the system waits at the Express Gate's first screen before starting Windows or other installed OS. Choose **[Prompt User]** to stay at the first screen of Express Gate for user action.

Configuration options: [Prompt User] [1 second] [3 seconds] [5 seconds] [10 seconds] [15 seconds] [20 seconds] [30 seconds]

Reset User Data [No]

Allows you to clear Express Gate's user data.

Configuration options: [No] [Reset]

When setting this item to **[Reset]**, make sure to save the setting to the BIOS so that the user data will be cleared the next time you enter the Express Gate. User data includes the Express Gate's settings as well as any personal information stored by the web browser (bookmarks, cookies, browsing history, etc.). This is useful in the rare case where corrupt settings prevent the Express Gate environment from launching properly.



The first time wizard will run again when you enter the Express Gate environment after clearing its settings.

5.7.3 AI NET 2

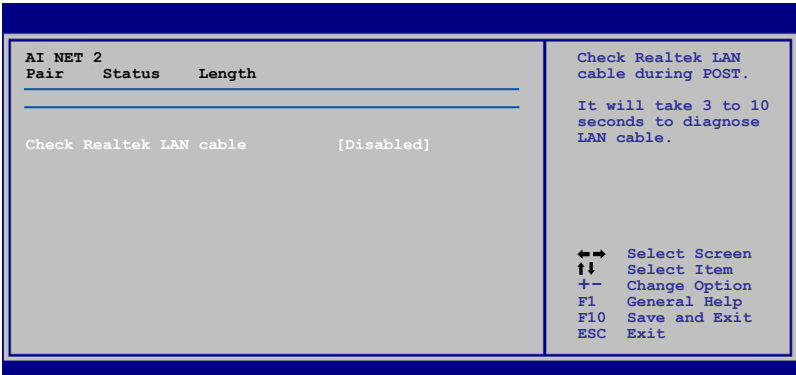

Check Realtek LAN cable [Disabled]

Enables or disables checking of the Realtek LAN cable during the Power-On Self-Test (POST).

Configuration options: [Disabled] [Enabled]

5.8 Exit menu

The Exit menu items allow you to load the optimal or failsafe default values for the BIOS items, and save or discard your changes to the BIOS items.

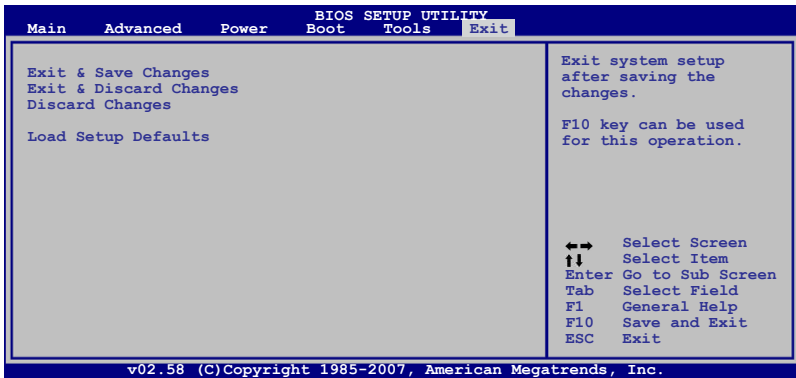

Pressing <Esc> does not immediately exit this menu. Select one of the options from this menu or <F10> from the legend bar to exit.

Exit & Save Changes

Once you are finished making your selections, choose this option from the Exit menu to ensure the values you selected are saved to the CMOS RAM. An onboard backup battery sustains the CMOS RAM so it stays on even when the PC is turned off. When you select this option, a confirmation window appears. Select YES to save changes and exit.



If you attempt to exit the Setup program without saving your changes, the program prompts you with a message asking if you want to save your changes before exiting. Press <Enter> to save the changes while exiting.

Exit & Discard Changes

Select this option only if you do not want to save the changes that you made to the Setup program. If you made changes to fields other than System Date, System Time, and Password, the BIOS asks for a confirmation before exiting.

Discard Changes

This option allows you to discard the selections you made and restore the previously saved values. After selecting this option, a confirmation appears. Select YES to discard any changes and load the previously saved values.

Load Setup Defaults

This option allows you to load the default values for each of the parameters on the Setup menus. When you select this option or if you press <F5>, a confirmation window appears. Select YES to load default values. Select Exit & Save Changes or make other changes before saving the values to the non-volatile RAM.

