

# P5LD2-VM



# Motherboard

**E2281**

**Revision 2**  
**Sep. 2005**

**Copyright © 2005 ASUSTeK COMPUTER INC. All Rights Reserved.**

No part of this manual, including the products and software described in it, may be reproduced, transmitted, transcribed, stored in a retrieval system, or translated into any language in any form or by any means, except documentation kept by the purchaser for backup purposes, without the express written permission of ASUSTeK COMPUTER INC. ("ASUS").

Product warranty or service will not be extended if: (1) the product is repaired, modified or altered, unless such repair, modification or alteration is authorized in writing by ASUS; or (2) the serial number of the product is defaced or missing.

ASUS PROVIDES THIS MANUAL "AS IS" WITHOUT WARRANTY OF ANY KIND, EITHER EXPRESS OR IMPLIED, INCLUDING BUT NOT LIMITED TO THE IMPLIED WARRANTIES OR CONDITIONS OF MERCHANTABILITY OR FITNESS FOR A PARTICULAR PURPOSE. IN NO EVENT SHALL ASUS, ITS DIRECTORS, OFFICERS, EMPLOYEES OR AGENTS BE LIABLE FOR ANY INDIRECT, SPECIAL, INCIDENTAL, OR CONSEQUENTIAL DAMAGES (INCLUDING DAMAGES FOR LOSS OF PROFITS, LOSS OF BUSINESS, LOSS OF USE OR DATA, INTERRUPTION OF BUSINESS AND THE LIKE), EVEN IF ASUS HAS BEEN ADVISED OF THE POSSIBILITY OF SUCH DAMAGES ARISING FROM ANY DEFECT OR ERROR IN THIS MANUAL OR PRODUCT.

SPECIFICATIONS AND INFORMATION CONTAINED IN THIS MANUAL ARE FURNISHED FOR INFORMATIONAL USE ONLY, AND ARE SUBJECT TO CHANGE AT ANY TIME WITHOUT NOTICE, AND SHOULD NOT BE CONSTRUED AS A COMMITMENT BY ASUS. ASUS ASSUMES NO RESPONSIBILITY OR LIABILITY FOR ANY ERRORS OR INACCURACIES THAT MAY APPEAR IN THIS MANUAL, INCLUDING THE PRODUCTS AND SOFTWARE DESCRIBED IN IT.

Products and corporate names appearing in this manual may or may not be registered trademarks or copyrights of their respective companies, and are used only for identification or explanation and to the owners' benefit, without intent to infringe.

# Contents

Notices .....	vi
Safety information .....	vii
About this guide .....	viii
Typography .....	ix
P5LD2-VM specifications summary .....	x

## Chapter 1: Product introduction

1.1	Welcome! .....	1-2
1.2	Package contents .....	1-2
1.3	Special features .....	1-2
	1.3.1 Product highlights .....	1-2
	1.3.2 Innovative ASUS features .....	1-4
1.4	Before you proceed .....	1-5
1.5	Motherboard overview .....	1-6
	1.5.1 Placement direction .....	1-6
	1.5.2 Screw holes .....	1-6
	1.5.3 Motherboard layout .....	1-7
1.6	Central Processing Unit (CPU) .....	1-8
	1.6.1 Installing the CPU .....	1-8
	1.6.2 Installing the CPU heatsink and fan .....	1-11
	1.6.3 Uninstalling the CPU heatsink and fan .....	1-13
1.7	System memory .....	1-15
	1.7.1 Overview .....	1-15
	1.7.2 Memory configurations .....	1-15
	1.7.3 DDR2 Qualified Vendors List .....	1-16
	1.7.4 Installing a DIMM .....	1-17
	1.7.5 Removing a DIMM .....	1-17
1.8	Expansion slots .....	1-18
	1.8.1 Installing an expansion card .....	1-18
	1.8.2 Configuring an expansion card .....	1-18
	1.8.3 Interrupt assignments .....	1-19
	1.8.4 PCI slots .....	1-20
	1.8.5 PCI Express x16 .....	1-20
	1.8.6 PCI Express x1 .....	1-20
1.9	Jumpers .....	1-21

## Contents

1.10	Connectors .....	1-22
1.10.1	Rear panel connectors .....	1-22
1.10.2	Internal connectors .....	1-24

### Chapter 2: BIOS setup

2.1	Managing and updating your BIOS .....	2-2
2.1.1	Creating a bootable floppy disk .....	2-2
2.1.2	ASUS EZ Flash utility .....	2-3
2.1.3	AFUDOS utility .....	2-4
2.1.4	ASUS CrashFree BIOS 2 utility .....	2-6
2.1.5	ASUS Update utility .....	2-8
2.2	BIOS setup program .....	2-11
2.2.1	BIOS menu screen .....	2-12
2.2.2	Menu bar .....	2-12
2.2.3	Navigation keys .....	2-12
2.2.4	Menu items .....	2-13
2.2.5	Sub-menu items .....	2-13
2.2.6	Configuration fields .....	2-13
2.2.7	Pop-up window .....	2-13
2.2.8	Scroll bar .....	2-13
2.2.9	General help .....	2-13
2.3	Main menu .....	2-14
2.3.1	System Time .....	2-14
2.3.2	System Date .....	2-14
2.3.3	Legacy Diskette A .....	2-14
2.3.4	Primary, Third and Fourth IDE Master/Slave .....	2-15
2.3.5	IDE Configuration .....	2-16
2.3.6	System Information .....	2-18
2.4	Advanced menu .....	2-19
2.4.1	JumperFree Configuration .....	2-19
2.4.2	USB Configuration .....	2-22
2.4.3	CPU Configuration .....	2-23
2.4.4	Chipset .....	2-25
2.4.5	Onboard Devices Configuration .....	2-26
2.4.6	PCI PnP .....	2-28

## Contents

2.5	Power menu .....	2-29
2.5.1	Suspend Mode .....	2-29
2.5.2	ACPI 2.0 Support .....	2-29
2.5.3	ACPI APIC Support .....	2-29
2.5.4	APM Configuration .....	2-30
2.5.5	Hardware Monitor .....	2-32
2.6	Boot menu .....	2-34
2.6.1	Boot Device Priority .....	2-34
2.6.2	Boot Settings Configuration .....	2-35
2.6.3	Security .....	2-36
2.7	Exit menu .....	2-38

### Chapter 3: Software support

3.1	Installing an operating system .....	3-2
3.2	Support CD information .....	3-2
3.2.1	Running the support CD .....	3-2
3.2.2	Drivers menu .....	3-3
3.2.3	Utilities menu .....	3-4
3.2.4	Manuals menu .....	3-5
3.2.5	ASUS Contact information .....	3-6

### Appendix: CPU features

A.1	Intel® EM64T .....	A-2
	Using the Intel® EM64T feature .....	A-2
A.2	Enhanced Intel SpeedStep® Technology (EIST) .....	A-2
A.2.1	System requirements .....	A-2
A.2.2	Using the EIST .....	A-3
A.3	Intel® Hyper-Threading Technology .....	A-4
	Using the Hyper-Threading Technology .....	A-4

## Notices

### Federal Communications Commission Statement

This device complies with Part 15 of the FCC Rules. Operation is subject to the following two conditions:

- This device may not cause harmful interference, and
- This device must accept any interference received including interference that may cause undesired operation.

This equipment has been tested and found to comply with the limits for a Class B digital device, pursuant to Part 15 of the FCC Rules. These limits are designed to provide reasonable protection against harmful interference in a residential installation. This equipment generates, uses and can radiate radio frequency energy and, if not installed and used in accordance with manufacturer's instructions, may cause harmful interference to radio communications. However, there is no guarantee that interference will not occur in a particular installation. If this equipment does cause harmful interference to radio or television reception, which can be determined by turning the equipment off and on, the user is encouraged to try to correct the interference by one or more of the following measures:

- Reorient or relocate the receiving antenna.
- Increase the separation between the equipment and receiver.
- Connect the equipment to an outlet on a circuit different from that to which the receiver is connected.
- Consult the dealer or an experienced radio/TV technician for help.



---

The use of shielded cables for connection of the monitor to the graphics card is required to assure compliance with FCC regulations. Changes or modifications to this unit not expressly approved by the party responsible for compliance could void the user's authority to operate this equipment.

---

### Canadian Department of Communications Statement

This digital apparatus does not exceed the Class B limits for radio noise emissions from digital apparatus set out in the Radio Interference Regulations of the Canadian Department of Communications.

**This class B digital apparatus complies with Canadian ICES-003.**

## Safety information

### Electrical safety

- To prevent electrical shock hazard, disconnect the power cable from the electrical outlet before relocating the system.
- When adding or removing devices to or from the system, ensure that the power cables for the devices are unplugged before the signal cables are connected. If possible, disconnect all power cables from the existing system before you add a device.
- Before connecting or removing signal cables from the motherboard, ensure that all power cables are unplugged.
- Seek professional assistance before using an adapter or extension cord. These devices could interrupt the grounding circuit.
- Make sure that your power supply is set to the correct voltage in your area. If you are not sure about the voltage of the electrical outlet you are using, contact your local power company.
- If the power supply is broken, do not try to fix it by yourself. Contact a qualified service technician or your retailer.

### Operation safety

- Before installing the motherboard and adding devices on it, carefully read all the manuals that came with the package.
- Before using the product, make sure all cables are correctly connected and the power cables are not damaged. If you detect any damage, contact your dealer immediately.
- To avoid short circuits, keep paper clips, screws, and staples away from connectors, slots, sockets and circuitry.
- Avoid dust, humidity, and temperature extremes. Do not place the product in any area where it may become wet.
- Place the product on a stable surface.
- If you encounter technical problems with the product, contact a qualified service technician or your retailer.

## About this guide

This user guide contains the information you need when installing and configuring the motherboard.

### How this guide is organized

This manual contains the following parts:

- **Chapter 1: Product introduction**

This chapter describes the features of the motherboard and the new technology it supports. This chapter also lists the hardware setup procedures that you have to perform when installing system components. It includes description of the jumpers and connectors on the motherboard.

- **Chapter 2: BIOS setup**

This chapter tells how to change system settings through the BIOS Setup menus. Detailed descriptions of the BIOS parameters are also provided.

- **Chapter 3: Software support**

This chapter describes the contents of the support CD that comes with the motherboard package.

### Where to find more information

Refer to the following sources for additional information and for product and software updates.

1. **ASUS websites**

The ASUS website provides updated information on ASUS hardware and software products. Refer to the ASUS contact information.

2. **Optional documentation**

Your product package may include optional documentation, such as warranty flyers, that may have been added by your dealer. These documents are not part of the standard package.



## Conventions used in this guide

To make sure that you perform certain tasks properly, take note of the following symbols used throughout this manual.



**DANGER/WARNING:** Information to prevent injury to yourself when trying to complete a task.



**CAUTION:** Information to prevent damage to the components when trying to complete a task.



**IMPORTANT:** Instructions that you **MUST** follow to complete a task.



**NOTE:** Tips and additional information to help you complete a task.

## Typography

### **Bold text**

Indicates a menu or an item to select

*Italics*

Used to emphasize a word or a phrase

<Key>

Keys enclosed in the less-than and greater-than sign means that you must press the enclosed key

Example: <Enter> means that you must press the Enter or Return key

<Key1+Key2+Key3>

If you must press two or more keys simultaneously, the key names are linked with a plus sign (+)

Example: <Ctrl+Alt+D>

### **Command**

Means that you must type the command exactly as shown, then supply the required item or value enclosed in brackets

Example: At the DOS prompt, type the command line:

```
afudos /i[filename]  
afudos /iP5LD2VM.ROM
```

## P5LD2-VM specifications summary

<b>CPU</b>	LGA775 socket for Intel® Pentium® D/Intel® Pentium® 4 or Intel® Celeron® processors Compatible with Intel® PCG 05B/05A and 04B/04A processors Supports Intel® Enhanced Memory 64 Technology (EM64T) Supports Enhanced Intel SpeedStep® Technology (EIST) Supports Intel® Hyper-Threading Technology
<b>Chipset</b>	Northbridge: Intel® 945G Southbridge: Intel® ICH7
<b>Front Side Bus</b>	1066/800/533 MHz
<b>Memory</b>	Dual-channel memory architecture 4 x 240-pin DIMM sockets support up to 4GB of unbuffered non-ECC 667/533 MHz DDR2 DIMMs
<b>VGA</b>	Integrated Intel® Graphics Media Accelerator 950
<b>Expansion slots</b>	1 x PCI Express x16 slot for discrete graphics cards 1 x PCI Express x1 2 x PCI slots
<b>Storage</b>	Intel® ICH7 SouthBridge supports: - 1 x Ultra DMA 100/66/33 - 4 x Serial ATA 3Gb/s ports ITE IDE controller supports: - 1 x UltraDMA 133/100
<b>Audio</b>	Realtek® ALC882 8-channel High-Definition audio CODEC S/PDIF out interface support Universal Audio Jack (UAJ®) Sensing Technology support
<b>LAN</b>	Intel® Gigabit LAN controller
<b>USB</b>	Supports up to 8 USB 2.0 ports
<b>Rear panel</b>	1 x Parallel port 1 x LAN (RJ-45) port 4 x USB 2.0 ports 1 x VGA port 1 x Serial port (COM) 1 x PS/2 keyboard port 1 x PS/2 mouse port 8-channel high-definition audio I/O ports

*(continued on the next page)*

## P5LD2-VM specifications summary

<b>BIOS features</b>	4 Mb Flash ROM, AMI BIOS, PnP, WfM2.0, DMI2.0, SM BIOS 2.3, ASUS EZ Flash, CrashFree BIOS2, C.P.R. (CPU Parameter Recall)
<b>Special features</b>	ASUS AI Overclocking ASUS EZ Flash ASUS CrashFree BIOS 2 ASUS MyLogo2™ ASUS CPR (CPU Parameter Recall)
<b>Industry standard</b>	PCI 2.2, USB 2.0
<b>Manageability</b>	WfM 2.0, DMI 2.0, WOL by PME, WOR by PME, Chassis Intrusion
<b>Internal connectors</b>	2 x USB 2.0 connectors for 4 additional USB 2.0 ports 1 x CPU fan connector 1 x Chassis fan connector 1 x Power fan connector 1 x 24-pin EATX power connector 1 x 4-pin ATX 12 V power connector 1 x CD in connector 1 x Chassis intrusion connector 1 x Front panel high-definition audio connector 1 x S/PDIF out connector
<b>Power Requirement</b>	ATX power supply (with 24-pin and 4-pin 12 V plugs)
<b>Form Factor</b>	Micro-ATX form factor: 9.6 in x 9.6 in
<b>Support CD contents</b>	Device drivers ASUS PC Probe II ASUS Live Update utility Anti-virus software (OEM version)

*\*Specifications are subject to change without notice.*



This chapter describes the motherboard features and the new technologies it supports.

# 1 Product introduction

## 1.1 Welcome!

### Thank you for buying an ASUS® P5LD2-VM motherboard!

The motherboard delivers a host of new features and latest technologies, making it another standout in the long line of ASUS quality motherboards!

Before you start installing the motherboard, and hardware devices on it, check the items in your package with the list below.

## 1.2 Package contents

Check your motherboard package for the following items.

<b>Motherboard</b>	ASUS P5LD2-VM motherboard
<b>Cables</b>	2 x Serial ATA signal cables 1 x Ultra DMA 133 cable 1 x Floppy disk drive cable
<b>Accessories</b>	I/O shield
<b>Application CDs</b>	ASUS motherboard support CD
<b>Documentation</b>	User guide



If any of the above items is damaged or missing, contact your retailer.

## 1.3 Special features

### 1.3.1 Product highlights

#### Latest processor technology

The motherboard comes with a 775-pin surface mount Land Grid Array (LGA) socket designed for the Intel® Pentium® D, Intel® Pentium® 4 or Intel® Celeron® processor in the 775-land package. The motherboard supports the Intel® Pentium® 4 or Intel® Pentium® D processor with 1066/800/533 MHz Front Side Bus (FSB). The motherboard also supports the Intel® Hyper-Threading Technology and is fully compatible with Intel® PCG 04B/04A and 05B/05A processors. See page 1-8 for details.

#### Intel® Dual-Core Technology CPU support

The motherboard supports dual-core processors containing two physical CPU cores with dedicated L2 caches to meet demands for more powerful processing. See page 1-8 for details.

## Intel® 945G chipset



The Intel® 945G graphics memory controller hub (GMCH) and the ICH7 I/O controller hub provide the vital interfaces for the motherboard. The GMCH features the Intel® Graphics Media Accelerator 950, an integrated graphics engine for enhanced 3D, 2D, and video capabilities. The GMCH provides the interface for a processor in the 775-land package with 533/800/1066 MHz front side bus (FSB), dual channel DDR2 at speeds of up to 667 MHz, and PCI Express x16 graphics card.

The Intel® ICH7 Southbridge represents the seventh generation I/O controller hub that provides the interface for PCI Express and 8-channel high definition audio.



## DDR2 memory support

The motherboard supports DDR2 memory which features data transfer rates of 600 MHz (FSB 800) or 533 MHz (FSB 1066/800) to meet the higher bandwidth requirements of the latest 3D graphics, multimedia, and Internet applications. The dual-channel DDR2 architecture doubles the bandwidth of your system memory to boost system performance, eliminating bottlenecks with peak bandwidths of up to 8.5 GB/s. See pages 1-15 to 1-17 for details.

## PCI Express™ interface



The motherboard fully supports PCI Express, the latest I/O interconnect technology that speeds up the PCI bus. PCI Express features point-to-point serial interconnections between devices and allows higher clockspeeds by carrying data in packets. This high speed interface is software compatible with existing PCI specifications. See page 1-20 for details.

## 64-bit CPU support



The motherboard supports 64-bit processors that provides high-performance computing and faster memory access required for memory and data intensive applications.

## AI Overclocking

This feature allows convenient overclocking up to 30 percent (depending on the installed CPU and DRAM) to enhance system performance while still maintaining system stability. See section “2.4.1 JumperFree Configuration” to set the BIOS items for overclocking.

## Serial ATA technology



The motherboard supports the Serial ATA technology through the Serial ATA interfaces and the Intel® ICH7 chipset. The SATA specification allows for thinner, more flexible cables with lower pin count, reduced voltage requirement, and up to 300 MB/s data transfer rate.

## 8-channel high definition audio



The onboard Realtek® ALC882 8-channel high-definition audio CODEC provides 192 KHz/ 24-bit audio output, jack-sensing and re-tasking functions. With the 8-channel audio ports and S/PDIF interfaces, you can connect your computer to home theater decoders to produce crystal-clear digital audio.

## S/PDIF digital sound ready



The motherboard supports the S/PDIF Out function through the S/PDIF interfaces at midboard. The S/PDIF technology turns your computer into a high-end entertainment system with digital connectivity to powerful audio and speaker systems. See page 1-27 for details.

## Temperature, fan, and voltage monitoring

The CPU temperature is monitored by the ASIC (integrated in the Winbond Super I/O) to prevent overheating and damage. The system fan rotations per minute (RPM) is monitored for timely failure detection. The ASIC monitors the voltage levels to ensure stable supply of current for critical components. See pages 2-32 and 2-33 for details.

## 1.3.2 Innovative ASUS features

### CrashFree BIOS 2



This feature allows you to restore the original BIOS data from the support CD in case when the BIOS codes and data are corrupted. This protection eliminates the need to buy a replacement ROM chip. See details on page 2-6.

### ASUS MyLogo2™



This new feature present in the motherboard allows you to personalize and add style to your system with customizable boot logos. See page 2-35.

### ASUS EZ Flash BIOS



With the ASUS EZ Flash, you can easily update the system BIOS even before loading the operating system. No need to use a DOS-based utility or boot from a floppy disk. See page 2-3 for details.

### C.P.R. (CPU Parameter Recall)



The C.P.R. feature of the motherboard BIOS allows automatic re-setting to the BIOS default settings in case the system hangs due to overclocking. When the system hangs due to overclocking, C.P.R. eliminates the need to open the system chassis and clear the RTC data. Simply shut down and reboot the system, and the BIOS automatically restores the CPU default setting for each parameter.



## 1.4 Before you proceed

Take note of the following precautions before you install motherboard components or change any motherboard settings.



- Unplug the power cord from the wall socket before touching any component.
- Use a grounded wrist strap or touch a safely grounded object or to a metal object, such as the power supply case, before handling components to avoid damaging them due to static electricity
- Hold components by the edges to avoid touching the ICs on them.
- Whenever you uninstall any component, place it on a grounded antistatic pad or in the bag that came with the component.
- **Before you install or remove any component, ensure that the ATX power supply is switched off or the power cord is detached from the power supply.** Failure to do so may cause severe damage to the motherboard, peripherals, and/or components.

### Onboard LED

The motherboard comes with a standby power LED that lights up to indicate that the system is ON, in sleep mode, or in soft-off mode. This is a reminder that you should shut down the system and unplug the power cable before removing or plugging in any motherboard component. The illustration below shows the location of the onboard LED.

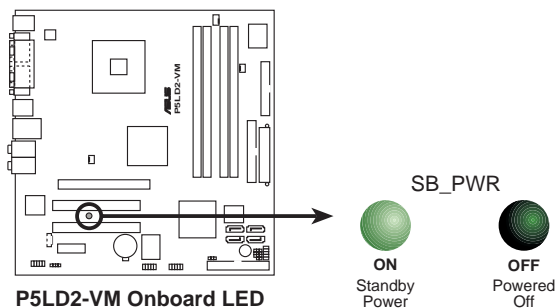

## 1.5 Motherboard overview

Before you install the motherboard, study the configuration of your chassis to ensure that the motherboard fits into it.



Make sure to unplug the power cord before installing or removing the motherboard. Failure to do so can cause you physical injury and damage motherboard components.

### 1.5.1 Placement direction

When installing the motherboard, make sure that you place it into the chassis in the correct orientation. The edge with external ports goes to the rear part of the chassis as indicated in the image below.

### 1.5.2 Screw holes

Place eight (8) screws into the holes indicated by circles to secure the motherboard to the chassis.



Do not overtighten the screws! Doing so can damage the motherboard.

Place this side towards  
the rear of the chassis

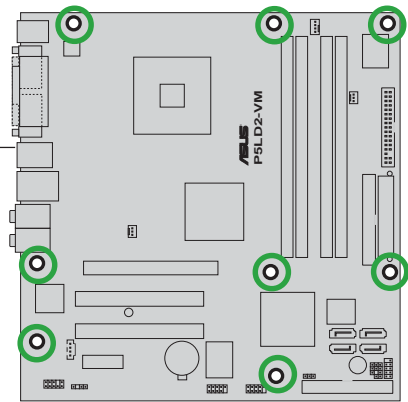

### 1.5.3 Motherboard layout

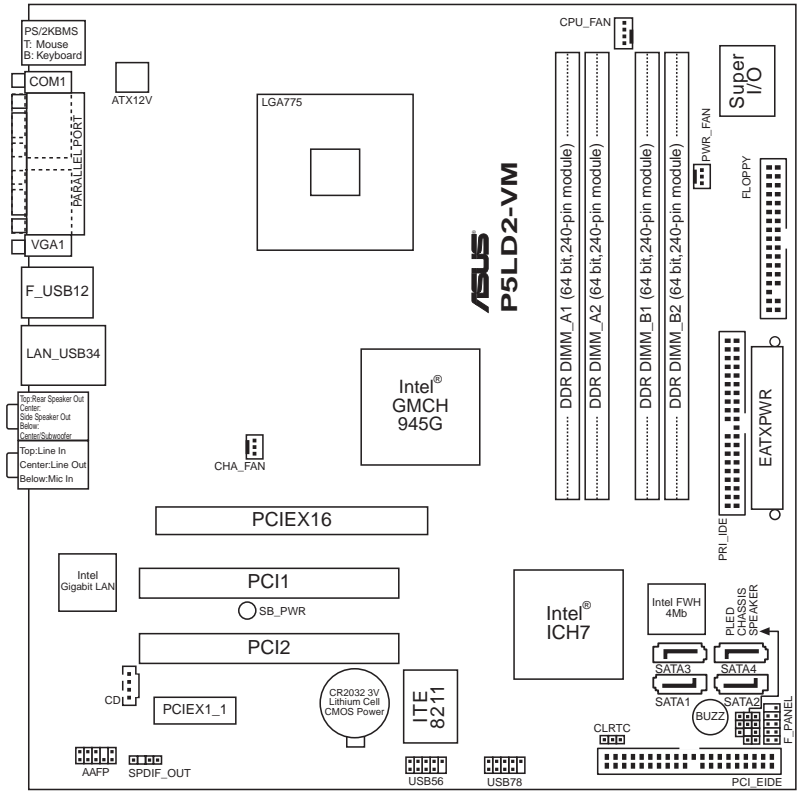

## 1.6 Central Processing Unit (CPU)

The motherboard comes with a surface mount LGA775 socket designed for the Intel® Pentium® 4 processor in the 775-land package.



- Your boxed Intel® Pentium® 4 LGA775 processor package should come with installation instructions for the CPU, fan and heatsink assembly. If the instructions in this section do not match the CPU documentation, follow the latter.
- Upon purchase of the motherboard, make sure that the PnP cap is on the socket and the socket pins are not bent. Contact your retailer immediately if the PnP cap is missing, or if you see any damage to the PnP cap/socket pins/motherboard components. ASUS will shoulder the cost of repair only if the damage is shipment/transit-related.
- Keep the cap after installing the motherboard. ASUS will process Return Merchandise Authorization (RMA) requests only if the motherboard comes with the cap on the LGA775 socket.
- The product warranty does not cover damage to the socket pins resulting from incorrect CPU installation/removal, or misplacement/loss/incorrect removal of the PnP cap.

### 1.6.1 Installing the CPU

To install a CPU:

1. Locate the CPU socket on the motherboard.

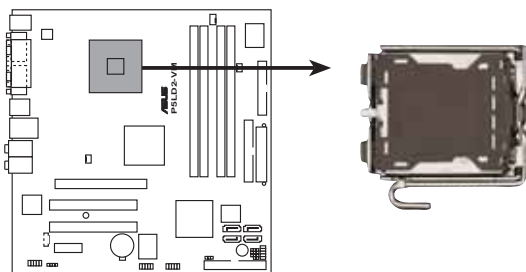

**P5LD2-VM CPU Socket 775**



Before installing the CPU, make sure that the socket box is facing towards you and the load lever is on your left.

2. Press the load lever with your thumb (A) and move it to the left (B) until it is released from the retention tab.

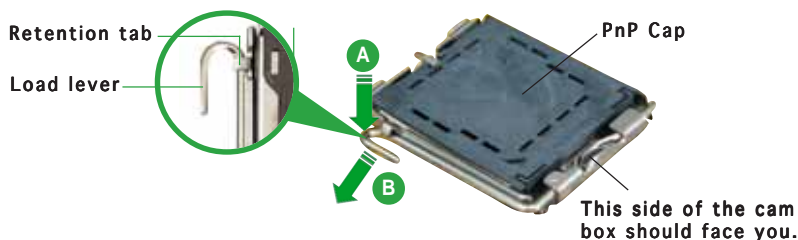

To prevent damage to the socket pins, do not remove the PnP cap unless you are installing a CPU.

3. Lift the load lever in the direction of the arrow to a 135° angle.

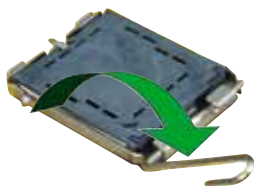

4. Lift the load plate with your thumb and forefinger to a 100° angle (A), then push the PnP cap from the load plate window to remove (B).

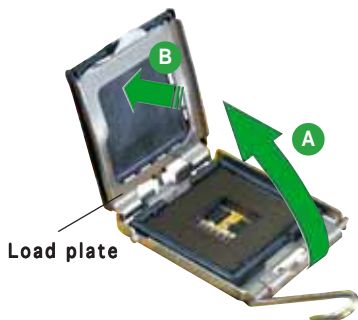

5. Position the CPU over the socket, making sure that the gold triangle is on the bottom-left corner of the socket. The socket alignment key should fit into the CPU notch.

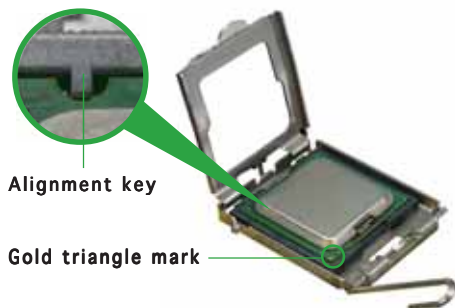

6. Close the load plate (A), then push the load lever (B) until it snaps into the retention tab.

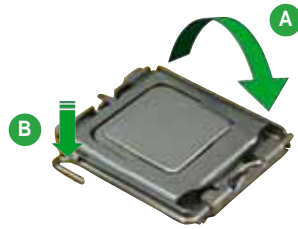

---

The CPU fits in only one correct orientation. DO NOT force the CPU into the socket to prevent bending the connectors on the socket and damaging the CPU!

---



---

The motherboard supports Intel® Pentium® D or Intel® Pentium® 4 LGA775 processors with the Intel® Enhanced Memory 64 Technology (EM64T), Enhanced Intel SpeedStep® Technology (EIST), and Hyper-Threading Technology. Refer to the Appendix for more information on these CPU features.

---

## 1.6.2 Installing the CPU heatsink and fan

The Intel® Pentium® 4 LGA775 processor requires a specially designed heatsink and fan assembly to ensure optimum thermal condition and performance.



- Install the motherboard to the chassis before you install the CPU fan and heatsink assembly
- When you buy a boxed Intel® Pentium® 4 processor, the package includes the CPU fan and heatsink assembly. If you buy a CPU separately, make sure that you use only Intel®-certified multi-directional heatsink and fan.
- Your Intel® Pentium® 4 LGA775 heatsink and fan assembly comes in a push-pin design and requires no tool to install.



If you purchased a separate CPU heatsink and fan assembly, make sure that a Thermal Interface Material is properly applied to the CPU heatsink or CPU before you install the heatsink and fan assembly.

To install the CPU heatsink and fan:

1. Place the heatsink on top of the installed CPU, making sure that the four fasteners match the holes on the motherboard.

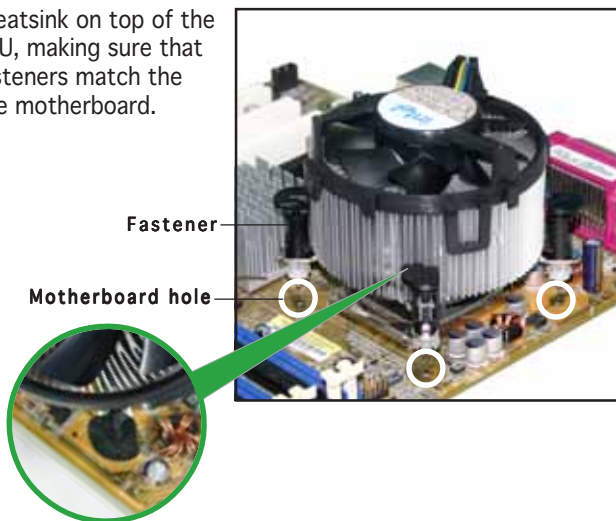

Make sure each fastener is oriented as shown, with the narrow groove directed outward.

2. Push down two fasteners at a time in a diagonal sequence to secure the heatsink and fan assembly in place.

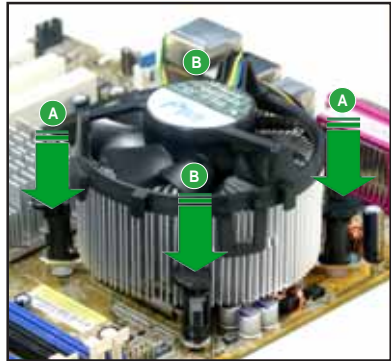
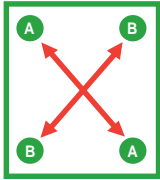

3. When the fan and heatsink assembly is in place, connect the CPU fan cable to the connector on the motherboard labeled CPU\_FAN.

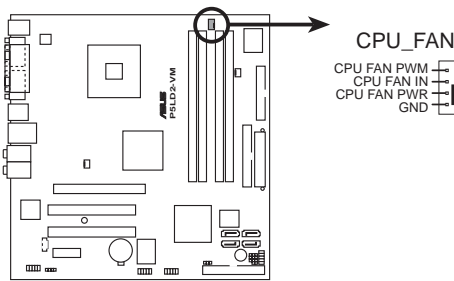

**P5LD2-VM CPU fan connector**



Do not forget to connect the CPU fan connector! Hardware monitoring errors can occur if you fail to plug this connector.



### 1.6.3 Uninstalling the CPU heatsink and fan

To uninstall the CPU heatsink and fan:

1. Disconnect the CPU fan cable from the connector on the motherboard.
2. Rotate each fastener counterclockwise.



3. Pull up two fasteners at a time in a diagonal sequence to disengage the heatsink and fan assembly from the motherboard.

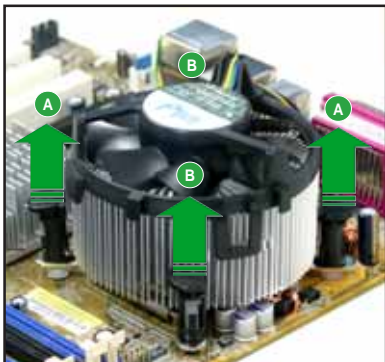
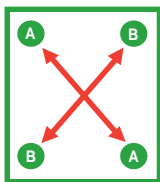

4. Remove the heatsink and fan assembly from the motherboard.



5. Rotate each fastener clockwise to reset the orientation.

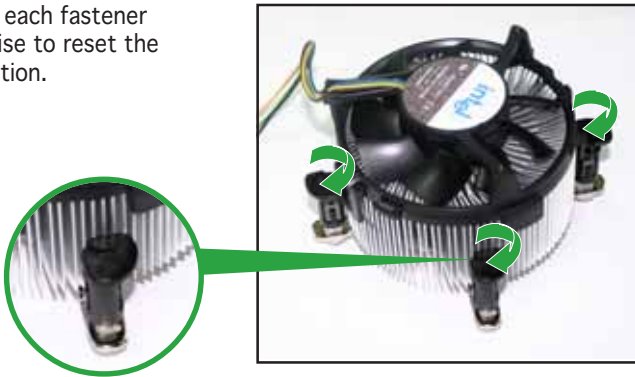

**Narrow end of the groove**



The narrow end of the groove should point outward after resetting. (The photo shows the groove shaded for emphasis.)



## 1.7 System memory

### 1.7.1 Overview

The motherboard comes with four Double Data Rate 2 (DDR2) Dual Inline Memory Modules (DIMM) sockets.

A DDR2 module has the same physical dimensions as a DDR DIMM but has a 240-pin footprint compared to the 184-pin DDR DIMM. DDR2 DIMMs are notched differently to prevent installation on a DDR DIMM socket.

The figure illustrates the location of the DDR2 DIMM sockets:

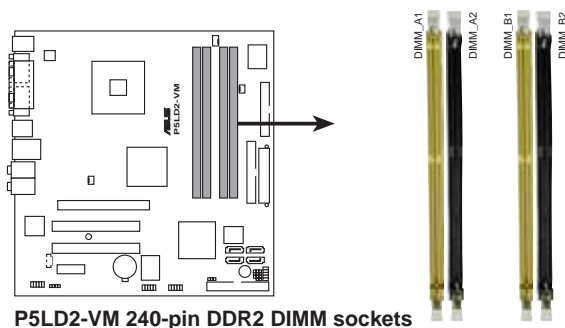

Channel	Sockets
Channel A	DIMM_A1 and DIMM_A2
Channel B	DIMM_B1 and DIMM_B2

### 1.7.2 Memory configurations

You may install 256 MB, 512 MB and 1 GB unbuffered non-ECC DDR2 DIMMs into the DIMM sockets.



- For dual-channel configuration, the total size of memory module(s) installed per channel must be the same (DIMM\_A1 + DIMM\_A2 = DIMM\_B1 + DIMM\_B2).
- Always install DIMMs with the same CAS latency. For optimum compatibility, it is recommended that you obtain memory modules from the same vendor. Refer to the DDR2 Qualified Vendors List on the next page for details.
- Due to chipset resource allocation, the system may detect less than 4 GB system memory when you installed four 1 GB DDR2 memory modules.
- This motherboard does not support memory modules made up of 128 Mb chips or double sided x16 memory modules.

### 1.7.3 DDR2 Qualified Vendors List

The following table lists the memory modules that have been tested and qualified for use with this motherboard. Visit the ASUS website ([www.asus.com](http://www.asus.com)) for the latest DDR2 DIMM modules for this motherboard.

#### DDR2 533 Qualified Vendors List

Size	Vendor	Model	Brand	Side(s)	Component	DIMM support		
						A	B	C
512MB	SAMSUNG	M378T6553BG0-CD5	N/A	SS	K4T51083QB-GCD5	•	•	•
256MB	SAMSUNG	M378T3253FG0-CD5	N/A	SS	K4T56083QF-GCD5	•	•	•
512MB	SAMSUNG	M378T6453FG0-CD5	N/A	DS	K4T56083QF-GCD5	•	•	•
512MB	Infineon	HYS64T64000GU-3.7-A	Infineon	SS	HYB18T512800AC37	•	•	•
256MB	Infineon	HYS64T32000HU-3.7-A	Infineon	SS	HYB18T512160AF-3.7	•	•	•
1024MB	Infineon	HYS64T128020HU-3.7-A	Infineon	DS	HYB18T512800AF37	•	•	•
512MB	Infineon	HYS64T64000HU-3.7-A	Infineon	SS	HYB18T512800AF37	•	•	•
512MB	CORSAIR	CM2X512-4200	N/A	DS	N/A	•	•	•
512MB	MICRON	MT16HTF6464AG-53EB2	MICRON	DS	4FBII9BQM	•	•	•
1024MB	MICRON	MT16HTF12864AY-53EA1	MICRON	DS	4JAIID9CRZ	•	•	•
256MB	MICRON	MT8HTF3264AY-53EB3	MICRON	SS	4FBII9CHM	•	•	•
512MB	MICRON	MT16HTF6464AY-53EB2	MICRON	DS	4FBII9CHM	•	•	•
1024MB	Kingston	D6408TE7BL-37	N/A	DS	E5108AB-5C-E	•	•	•
256MB	Kingston	E5116AB-5C-E	N/A	SS	HYB18T512160AC-3.7	•	•	•
512MB	Kingston	HYSP56821F-C4	ELPIDA	SS	E5108AB-5C-E	•	•	•
512MB	Hynix	HYMP564U64B-C4	N/A	SS	HY5PS12821F-C4	•	•	•
512MB	Hynix	HY5PS1282AFP-C3	N/A	SS	HYMP564U64APB-C3	•	•	•
1024MB	Hynix	HYMP512U64B-C4	N/A	DS	HY5PS12821FP-C4	•	•	•
512MB	ELPIDA	EBE51UD8ABFA-5C	ELPIDA	DS	E5108AB-5C-E	•	•	•
1024MB	ELPIDA	EBE11UD8ABFA-5C-E	ELPIDA	DS	E5108AB-5C-E	•	•	•

#### DDR2 667 Qualified Vendors List

Size	Vendor	Model	Brand	Side(s)	Component	DIMM support		
						A	B	C
512MB	Hynix	HYMP564U64APB-Y5	Hynix	SS	HY5PS12821AFP-Y5	•	•	•
1024MB	Hynix	HYMP512U64APB-Y4	Hynix	DS	HY5PS12821AFP-Y4	•	•	•
512MB	Hynix	HYMP564U64APB-Y4	Hynix	SS	HY5PS12821AFP-Y4	•	•	•
256MB	MICRON	MT8HTF3264AY-667B5	MICRON	SS	4SB42D9C2M	•	•	•
256MB	MICRON	MT8HTF3264AY-667B6	MICRON	SS	5FB42D9DPN	•	•	•
512MB	Infineon	HYS64T64000HU-3S-A	Infineon	SS	HYB18T512800AF3S	•	•	•
256MB	Infineon	HYS64T32000HU-3S-A	Infineon	SS	HYB18T512160AF-3S	•	•	•
1024MB	Infineon	HYS64T128020HU-3S-A	Infineon	DS	HYB18T512800AF3S	•	•	•
256MB	ELPIDA	EBE25UC8ABFA-6E-E	ELPIDA	SS	E2508AB-GE-E	•	•	•
512MB	ELPIDA	EBE51UD8AEFA-6E-E	ELPIDA	SS	E5108AE-GE-E	•	•	•
1024MB	ELPIDA	EBE11UD8AEFA-6E-E	N/A	DS	N/A	•	•	•

**Side(s):** SS - Single Sided

DS - Double Sided

#### DIMM Support:

**A** - supports one module inserted into either slot, in a Single-channel memory configuration.

**B** - supports on pair of modules inserted into either the yellow slots or the black slots as one pair of Dual-channel memory configuration.

**C** - support for 4 modules inserted into the yellow and black slots as two pairs of Dual-channel memory configuration.

### 1.7.4 Installing a DIMM



Unplug the power supply before adding or removing DIMMs or other system components. Failure to do so can cause severe damage to both the motherboard and the components.

To install a DIMM:

1. Unlock a DIMM socket by pressing the retaining clips outward.
2. Align a DIMM on the socket such that the notch on the DIMM matches the break on the socket.
3. Firmly insert the DIMM into the socket until the retaining clips snap back in place and the DIMM is properly seated.

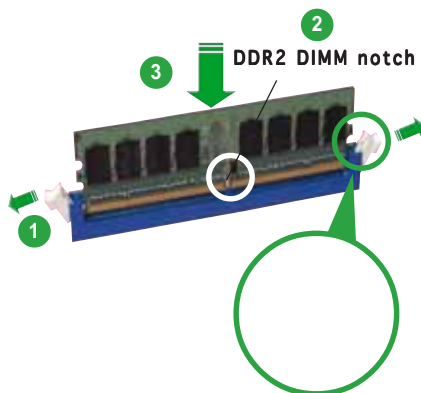

Unlocked retaining clip



- A DDR2 DIMM is keyed with a notch so that it fits in only one direction. Do not force a DIMM into a socket to avoid damaging the DIMM.
- The DDR2 DIMM sockets do not support DDR DIMMs. DO not install DDR DIMMs to the DDR2 DIMM sockets.

### 1.7.5 Removing a DIMM

Follow these steps to remove a DIMM.

1. Simultaneously press the retaining clips outward to unlock the DIMM.



Support the DIMM lightly with your fingers when pressing the retaining clips. The DIMM might get damaged when it flips out with extra force.

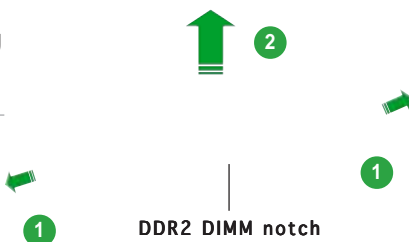

2. Remove the DIMM from the socket.

## 1.8 Expansion slots

In the future, you may need to install expansion cards. The following sub-sections describe the slots and the expansion cards that they support.



---

Make sure to unplug the power cord before adding or removing expansion cards. Failure to do so may cause you physical injury and damage motherboard components.

---

### 1.8.1 Installing an expansion card

To install an expansion card:

1. Before installing the expansion card, read the documentation that came with it and make the necessary hardware settings for the card.
2. Remove the system unit cover (if your motherboard is already installed in a chassis).
3. Remove the bracket opposite the slot that you intend to use. Keep the screw for later use.
4. Align the card connector with the slot and press firmly until the card is completely seated on the slot.
5. Secure the card to the chassis with the screw you removed earlier.
6. Replace the system cover.

### 1.8.2 Configuring an expansion card

After installing the expansion card, configure it by adjusting the software settings.

1. Turn on the system and change the necessary BIOS settings, if any. See Chapter 2 for information on BIOS setup.
2. Assign an IRQ to the card. Refer to the tables on the next page.
3. Install the software drivers for the expansion card.

## 1.8.3 Interrupt assignments

### Standard interrupt assignments

IRQ	Standard Function
0	System Timer
1	Keyboard Controller
2	Re-direct to IRQ#9
4	Communications Port (COM1)*
5	IRQ holder for PCI steering*
6	Floppy Disk Controller
7	Printer Port (LPT1)*
8	System CMOS/Real Time Clock
9	IRQ holder for PCI steering*
10	IRQ holder for PCI steering*
11	IRQ holder for PCI steering*
12	PS/2 Compatible Mouse Port*
13	Numeric Data Processor
14	Primary IDE Channel

\* These IRQs are usually available for ISA or PCI devices.

### IRQ assignments for this motherboard

	A	B	C	D	E	F	G	H
PCI slot 1	—	—	—	—	—	shared	—	—
PCI slot 2	—	—	—	—	—	—	shared	—
PCI Express x16 slot	shared	—	—	—	—	—	—	—
PCI Express x1 slot	shared	—	—	—	—	—	—	—
Onboard USB controller 1	—	—	—	—	shared	—	—	—
Onboard USB controller 2	—	shared	—	—	—	—	—	—
Onboard USB controller 3	—	—	shared	—	—	—	—	—
Onboard USB controller 4	—	—	—	shared	—	—	—	—
Onboard USB 2.0 controller	—	—	—	—	shared	—	—	—
Onboard IDE port	—	—	—	shared	—	—	—	—
Onboard HD audio	—	—	—	shared	—	—	—	—
Onboard LAN	—	shared	—	—	—	—	—	—



When using PCI cards on shared slots, ensure that the drivers support “Share IRQ” or that the cards do not need IRQ assignments. Otherwise, conflicts will arise between the two PCI groups, making the system unstable and the card inoperable.

### 1.8.4 PCI slots

The PCI slots support cards such as a LAN card, SCSI card, USB card, and other cards that comply with PCI specifications. The figure shows a LAN card installed on a PCI slot.

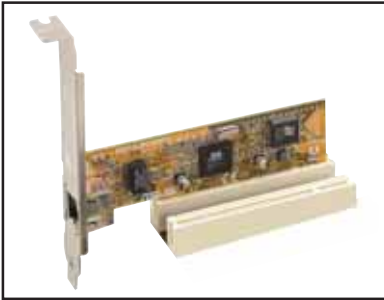

### 1.8.5 PCI Express x16

This motherboard supports one PCI Express x16 graphics card. The figure shows a graphics card installed on the PCI Express x16 slot.



### 1.8.6 PCI Express x1

This motherboard supports PCI Express x1 network cards, SCSI cards and other cards that comply with the PCI Express specifications. The figure shows a network card installed on the PCI Express x1 slot.

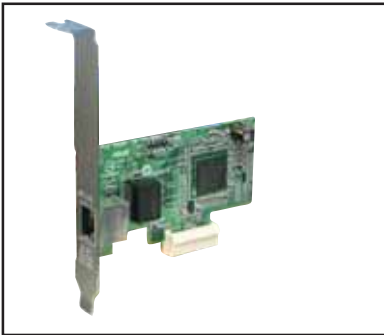



## 1.9 Jumpers

### 1. Clear RTC RAM (CLRRTC)

This jumper allows you to clear the Real Time Clock (RTC) RAM in CMOS. You can clear the CMOS memory of date, time, and system setup parameters by erasing the CMOS RTC RAM data. The onboard button cell battery powers the RAM data in CMOS, which include system setup information such as system passwords.

To erase the RTC RAM:

1. Turn OFF the computer and unplug the power cord.
2. Remove the onboard battery.
3. Move the jumper cap from pins 1-2 (default) to pins 2-3. Keep the cap on pins 2-3 for about 5~10 seconds, then move the cap back to pins 1-2.
4. Re-install the battery.
5. Plug the power cord and turn ON the computer.
6. Hold down the <Del> key during the boot process and enter BIOS setup to re-enter data.



Except when clearing the RTC RAM, never remove the cap on CLRRTC jumper default position. Removing the cap will cause system boot failure!

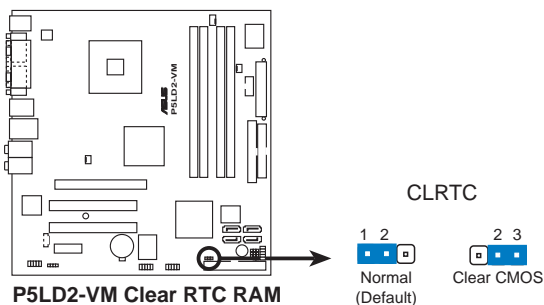

You do not need to clear the RTC when the system hangs due to overclocking. For system failure due to overclocking, use the C.P.R. (CPU Parameter Recall) feature. Shut down and reboot the system so the BIOS can automatically reset parameter settings to default values.

## 1.10 Connectors

### 1.10.1 Rear panel connectors

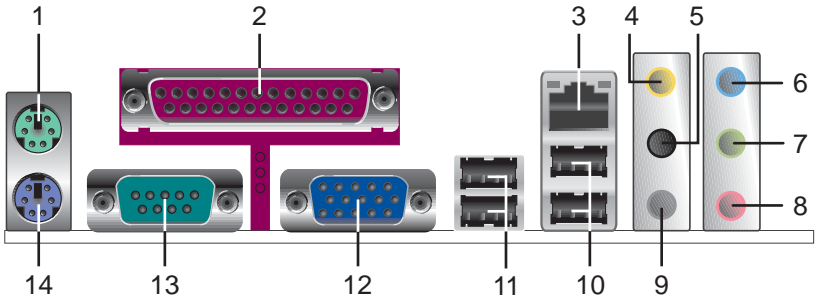

- 1. PS/2 mouse port (green).** This port is for a PS/2 mouse.
- 2. Parallel port.** This 25-pin port connects a parallel printer, a scanner, or other devices.
- 3. LAN (RJ-45) port.** This port allows Gigabit connection to a Local Area Network (LAN) through a network hub. Refer to the table below for the LAN port LED indications.

#### LAN port LED indications

ACT/LINK LED		SPEED LED	
Status	Description	Status	Description
OFF	No link	OFF	10 Mbps connection
GREEN	Linked	ORANGE	100 Mbps connection
BLINKING	Data activity	GREEN	1 Gbps connection

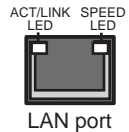

- 4. Rear Speaker Out port (orange).** This port connects the rear speakers on a 4-channel, 6-channel, or 8-channel audio configuration.
- 5. Side Speaker Out port (black).** This port connects the side speakers in an 8-channel audio configuration.
- 6. Line In port (light blue).** This port connects a tape, CD, DVD player, or other audio sources.
- 7. Line Out port (lime).** This port connects a headphone or a speaker. In 4-channel, 6-channel, and 8-channel configuration, the function of this port becomes Front Speaker Out.

8. **Microphone port (pink).** This port connects a microphone.
9. **Center/Subwoofer port (gray).** This port connects the center/subwoofer speakers.



---

Refer to the audio configuration table below for the function of the audio ports in 2, 4, 6, or 8-channel configuration.

---

### Audio 2, 4, 6, or 8-channel configuration

Port	2-channel (Headset)	4-channel	6-channel	8-channel
<b>Light Blue</b>	Line In	Line In	Line In	Line In
<b>Lime</b>	Line Out	Front Speaker Out	Front Speaker Out	Front Speaker Out
<b>Pink</b>	Mic In	Mic In	Mic In	Mic In
<b>Orange</b>	—	Rear Speaker Out	Rear Speaker Out	Rear Speaker Out
<b>Black</b>	—	—	—	Side Speaker Out
<b>Gray</b>	—	—	Center/Subwoofer	Center/Subwoofer

10. **USB 2.0 ports 3 and 4.** These two 4-pin Universal Serial Bus (USB) ports are available for connecting USB 2.0 devices.
11. **USB 2.0 ports 1 and 2.** These two 4-pin Universal Serial Bus (USB) ports are available for connecting USB 2.0 devices.
12. **VGA port.** This 15-pin VGA port connects to a VGA monitor.
13. **Serial connector.** This 9-pin COM1 port is for serial devices.
14. **PS/2 keyboard port (purple).** This port is for a PS/2 keyboard.

## 1.10.2 Internal connectors

### 1. Floppy disk drive connector (34-1 pin FLOPPY)

This connector is for the provided floppy disk drive (FDD) signal cable. Insert one end of the cable to this connector, then connect the other end to the signal connector at the back of the floppy disk drive.



Pin 5 on the connector is removed to prevent incorrect cable connection when using an FDD cable with a covered Pin 5.

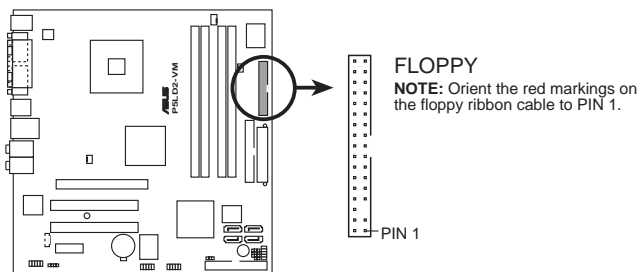

**P5LD2-VM Floppy disk drive connector**

### 2. Primary IDE connector (40-1 pin PRI\_IDE)

These connectors are for Ultra DMA 100/66 signal cables. The Ultra DMA 100/66 signal cable has three connectors: a blue connector for the primary IDE connector on the motherboard, a black connector for an Ultra DMA 100/66 IDE slave device (optical drive/hard disk drive), and a gray connector for an Ultra DMA 100/66 IDE master device (hard disk drive). If you install two hard disk drives, you must configure the second drive as a slave device by setting its jumper accordingly. Refer to the hard disk documentation for the jumper settings.



- Pin 20 on the IDE connector is removed to match the covered hole on the Ultra DMA cable connector. This prevents incorrect insertion when you connect the IDE cable.
- Use the 80-conductor IDE cable for Ultra DMA 100/66 IDE devices.

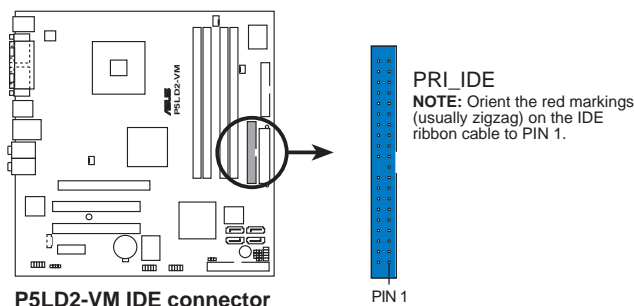

**P5LD2-VM IDE connector**

### 3. ITE IDE connector (40-1 pin PRI\_EIDE [red])

Supported by the ITE8211F controller, this connector is for Ultra ATA 133/100/66 signal cables. This connector supports two IDE hard disk drives for easier data storage.

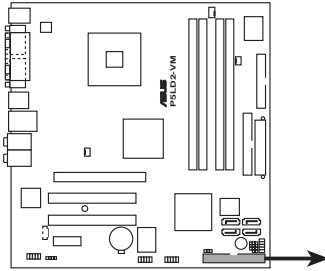

**P5LD2-VM PRI\_EIDE connector**



**NOTE:** Orient the red markings (usually zigzag) on the IDE cable to PIN 1.

### 4. Serial ATA connectors (7-pin SATA1, SATA2, SATA3, SATA4)

These connectors are for the Serial ATA signal cables for Serial ATA hard disk drives.

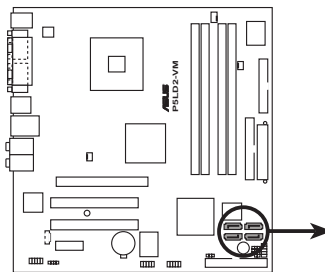

**P5LD2-VM SATA connectors**

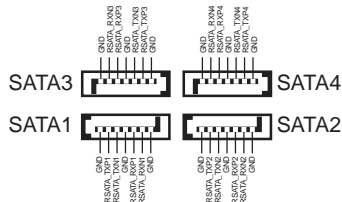

Install the Windows® 2000 Service Pack 4 or the Windows® XP Service Pack1 or later before using Serial ATA.

### 5. Speaker connector (4-pin SPEAKER)

This 4-pin connector is for the chassis-mounted system warning speaker. The speaker allows you to hear system beeps and warnings.

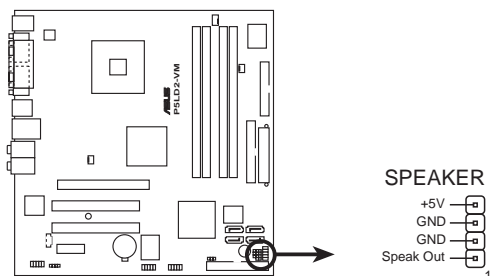

**P5LD2-VM Speaker out connector**

### 6. CPU, Power and Chassis fan connectors (4-pin CPU\_FAN, 3-pin PWR\_FAN, 3-pin CHA\_FAN)

The fan connectors support cooling fans of 350mA~740mA (8.88W max.) or a total of 1A~2.22A (26.64W max.) at +12V. Connect the fan cables to the fan connectors on the motherboard, making sure that the black wire of each cable matches the ground pin of the connector.



Do not forget to connect the fan cables to the fan connectors. Insufficient air flow inside the system may damage the motherboard components. These are not jumpers! DO NOT place jumper caps on the fan connectors.

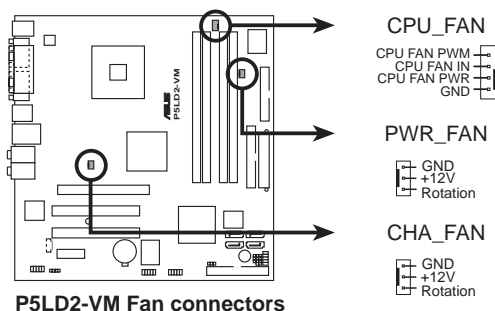

**P5LD2-VM Fan connectors**

### 7. Digital Audio connector (4-1 pin SPDIF\_OUT)

This connector is for the S/PDIF audio module to allow digital sound output. Connect one end of the S/PDIF audio cable to this connector and the other end to the S/PDIF module.

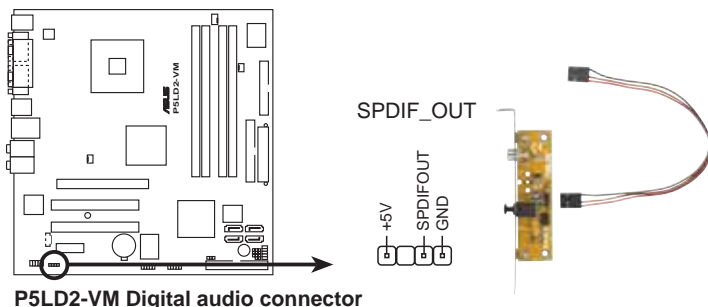

The S/PDIF out module is purchased separately.

### 8. Power LED connector (3-pin PLED)

This 3-pin connector is for the system power LED. The system power LED lights up when you turn on the system power, and blinks when the system is in sleep mode.

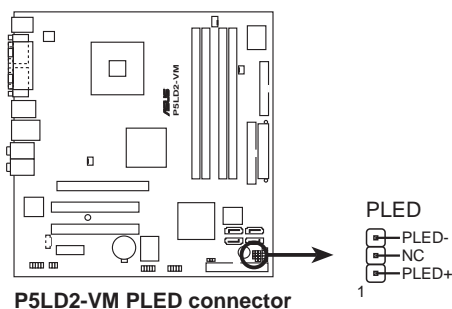

## 9. ATX power connectors (24-pin EATXPWR and 4-pin ATX12V)

These connectors are for ATX power supply plugs. The power supply plugs are designed to fit these connectors in only one orientation. Find the proper orientation and push down firmly until the connectors completely fit.



- Do not forget to connect the 4-pin ATX +12 V power plug; otherwise, the system will not boot.
- Use of a PSU with a higher power output is recommended when configuring a system with more power-consuming devices. The system may become unstable or may not boot up if the power is inadequate.
- Make sure that your power supply unit (PSU) can provide at least the minimum power required by your system. See the table below for details.

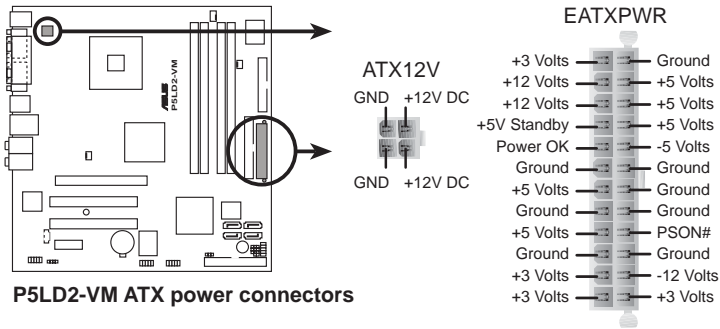



### 10. Optical drive audio connector (4-pin CD)

This connector is for the 4-pin audio cable that connects to the audio connector at the back of the optical drive.

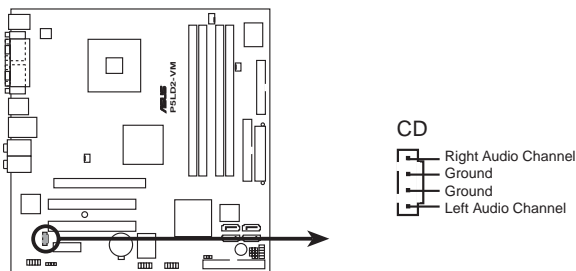

**P5LD2-VM CD audio connector**



Enable the CD-IN function in the audio utility when using this connector.

### 11. USB connectors (10-1 pin USB56, USB78)

These connectors are for USB 2.0 ports. Connect the optional USB module cable to any of these connectors, then install the module to a slot opening at the back of the system chassis. These USB connectors comply with USB 2.0 specification that supports up to 480 Mbps connection speed.

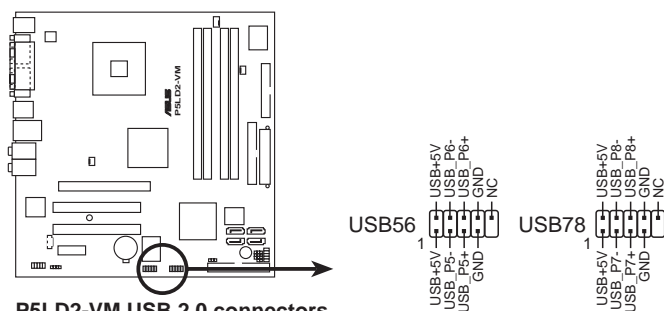

**P5LD2-VM USB 2.0 connectors**

## 12. Front panel audio connector (10-1 pin AAFP)

This connector is for a chassis-mounted front panel audio I/O module that supports either HD Audio or legacy AC'97 audio standard.

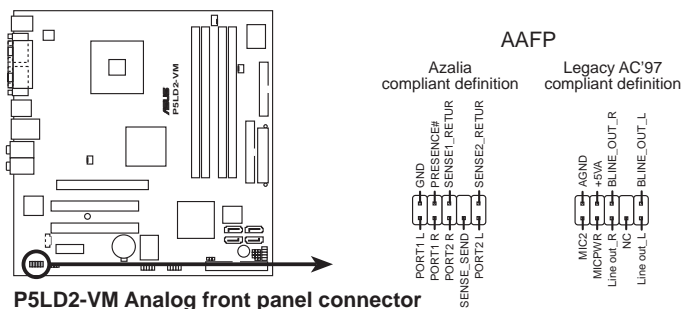

It is recommended that you connect a high-definition front panel audio module to this connector to avail of the motherboard's high-definition audio capability.

## 13. Chassis intrusion connector (4-1 pin CHASSIS)

This connector is for a chassis-mounted intrusion detection sensor or switch. Connect one end of the chassis intrusion sensor or switch cable to this connector. The chassis intrusion sensor or switch sends a high-level signal to this connector when a chassis component is removed or replaced. The signal is then generated as a chassis intrusion event.

By default, the pins labeled "Chassis Signal" and "Ground" are shorted with a jumper cap. Remove the jumper caps only when you intend to use the chassis intrusion detection feature.

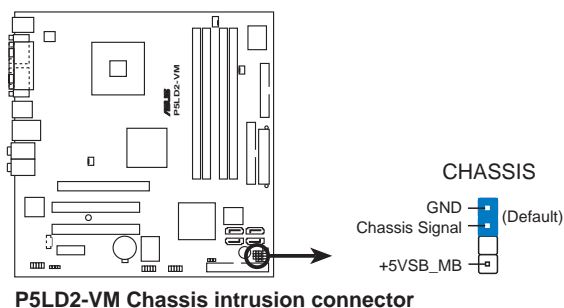

## 14. System panel connector (10-1 pin F\_PANEL)

This connector supports several chassis-mounted functions.

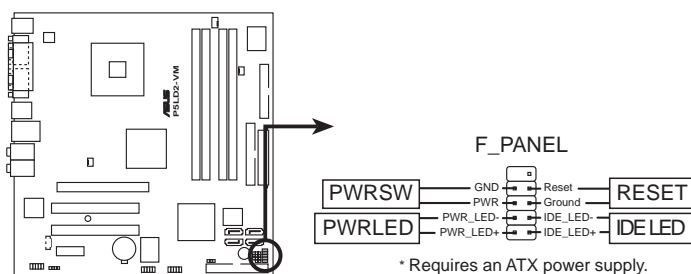

**P5LD2-VM System panel connector**



The system panel connector is color-coded for easy connection. Refer to the connector description below for details.

- Power/Soft-off button (Black 2-pin PWRSW)**  
 This connector is for the system power button. Pressing the power button turns the system ON or puts the system in SLEEP or SOFT-OFF mode depending on the BIOS settings. Pressing the power switch for more than four seconds while the system is ON turns the system OFF.
- System Power LED connector (2-pin PWRLED)**  
 This 2-pin connector is for the system power LED. The system power LED lights up when you turn on the system power, and blinks when the system is in sleep mode.
- Reset button (Blue 2-pin RESET)**  
 This 2-pin connector is for the chassis-mounted reset button for system reboot without turning off the system power.
- Hard disk drive activity (Red 2-pin IDELED)**  
 This 2-pin connector is for the HDD Activity LED. Connect the HDD Activity LED cable to this connector. The IDE LED lights up or flashes when data is read from or written to the HDD.



This chapter tells how to change the system settings through the BIOS Setup menus. Detailed descriptions of the BIOS parameters are also provided.

# BIOS setup

## 2.1 Managing and updating your BIOS

The following utilities allow you to manage and update the motherboard Basic Input/Output System (BIOS) setup.

1. **ASUS AFUDOS** (Updates the BIOS in DOS mode using a bootable floppy disk.)
2. **ASUS EZ Flash** (Updates the BIOS using a floppy disk during POST.)
3. **ASUS CrashFree BIOS 2** (Updates the BIOS using a bootable floppy disk or the motherboard support CD when the BIOS file fails or gets corrupted.)
4. **ASUS Update** (Updates the BIOS in Windows® environment.)

Refer to the corresponding sections for details on these utilities.



---

Save a copy of the original motherboard BIOS file to a bootable floppy disk in case you need to restore the BIOS in the future. Copy the original motherboard BIOS using the ASUS Update or AFUDOS utilities.

---

### 2.1.1 Creating a bootable floppy disk

1. Do either one of the following to create a bootable floppy disk.

#### DOS environment

- a. Insert a 1.44MB floppy disk into the drive.
- b. At the DOS prompt, type `format A:/S` then press <Enter>.

#### Windows® XP environment

- a. Insert a 1.44 MB floppy disk to the floppy disk drive.
- b. Click **Start** from the Windows® desktop, then select **My Computer**.
- c. Select the 3 1/2 Floppy Drive icon.
- d. Click **File** from the menu, then select **Format**. A **Format 3 1/2 Floppy Disk** window appears.
- e. Select **Create an MS-DOS startup disk** from the format options field, then click **Start**.

#### Windows® 2000 environment

To create a set of boot disks for Windows® 2000:

- a. Insert a formatted, high density 1.44 MB floppy disk into the drive.
- b. Insert the Windows® 2000 CD to the optical drive.
- c. Click **Start**, then select **Run**.

- d. From the Open field, type  
D:\bootdisk\makeboot a:  
assuming that D: is your optical drive.
  - e. Press <Enter>, then follow screen instructions to continue.
2. Copy the original or the latest motherboard BIOS file to the bootable floppy disk.

## 2.1.2 ASUS EZ Flash utility

The ASUS EZ Flash feature allows you to update the BIOS without having to go through the long process of booting from a floppy disk and using a DOS-based utility. The EZ Flash utility is built-in the BIOS chip so it is accessible by pressing <Alt> + <F2> during the Power-On Self Tests (POST).

To update the BIOS using EZ Flash:

1. Visit the ASUS website ([www.asus.com](http://www.asus.com)) to download the latest BIOS file for the motherboard and rename the same to **P5LD2VM.ROM**.
2. Save the BIOS file to a floppy disk, then restart the system.
3. Press <Alt> + <F2> during POST to display the following.

```
EZFlash starting BIOS update
Checking for floppy...
```

4. Insert the floppy disk that contains the BIOS file to the floppy disk drive. When the correct BIOS file is found, EZ Flash performs the BIOS update process and automatically reboots the system when done.

```
EZFlash starting BIOS update
Checking for floppy...
Floppy found!
Reading file "P5LD2VM.ROM". Completed.
Start erasing.....|
Start programming...|
Flashed successfully. Rebooting.
```



- Do not shutdown or reset the system while updating the BIOS to prevent system boot failure!
- A "Floppy not found!" error message appears if there is no floppy disk in the drive. A "P5LD2VM.ROM not found!" error message appears if the correct BIOS file is not found in the floppy disk. Make sure that you rename the BIOS file to P5LD2VM.ROM.

### 2.1.3 AFUDOS utility

The AFUDOS utility allows you to update the BIOS file in DOS environment using a bootable floppy disk with the updated BIOS file. This utility also allows you to copy the current BIOS file that you can use as backup when the BIOS fails or gets corrupted during the updating process.

#### Copying the current BIOS

To copy the current BIOS file using the AFUDOS utility:



- 
- Make sure that the floppy disk is not write-protected and has at least 600 KB free space to save the file.
  - The succeeding BIOS screens are for reference only. The actual BIOS screen displays may not be exactly the same as shown.
- 

1. Copy the AFUDOS utility (afudos.exe) from the motherboard support CD to the bootable floppy disk you created earlier.
2. Boot the system in DOS mode, then at the prompt type:

```
afudos /o[filename]
```

where the [filename] is any user-assigned filename not more than eight alphanumeric characters for the main filename and three alphanumeric characters for the extension name.

```
A:\>afudos /oOLDBIOS1.ROM
```

Main filename      Extension name

3. Press <Enter>. The utility copies the current BIOS file to the floppy disk.

```
A:\>afudos /oOLDBIOS1.ROM
AMI Firmware Update Utility - Version 1.10
Copyright (C) 2002 American Megatrends, Inc. All rights reserved.
Reading flash ..... done
A:\>
```

The utility returns to the DOS prompt after copying the current BIOS file.



## Updating the BIOS file

To update the BIOS file using the AFUDOS utility:

1. Visit the ASUS website ([www.asus.com](http://www.asus.com)) and download the latest BIOS file for the motherboard. Save the BIOS file to a bootable floppy disk.



---

Write the BIOS filename on a piece of paper. You need to type the exact BIOS filename at the DOS prompt.

---

2. Copy the AFUDOS utility (afudos.exe) from the motherboard support CD to the bootable floppy disk you created earlier.
3. Boot the system in DOS mode, then at the prompt type:

```
afudos /i[filename]
```

where [filename] is the latest or the original BIOS file on the bootable floppy disk.

```
A:\>afudos /iP5LD2VM.ROM
```

4. The utility verifies the file and starts updating the BIOS.

```
A:\>afudos /iP5LD2VM.ROM
AMI Firmware Update Utility - Version 1.10
Copyright (C) 2002 American Megatrends, Inc. All rights reserved.
  Reading file ..... done
  Erasing flash .... done
  Writing flash .... 0x0008CC00 (9%)
```



---

Do not shut down or reset the system while updating the BIOS to prevent system boot failure!

---

5. The utility returns to the DOS prompt after the BIOS update process is completed. Reboot the system from the hard disk drive.

```
A:\>afudos /iP5LD2VM.ROM
AMI Firmware Update Utility - Version 1.10
Copyright (C) 2002 American Megatrends, Inc. All rights reserved.
  Reading file ..... done
  Erasing flash .... done
  Writing flash .... 0x0008CC00 (9%)
  Verifying flash .. done
A:\>
```

## 2.1.4 ASUS CrashFree BIOS 2 utility

The ASUS CrashFree BIOS 2 is an auto recovery tool that allows you to restore the BIOS file when it fails or gets corrupted during the updating process. You can update a corrupted BIOS file using the motherboard support CD or the floppy disk that contains the updated BIOS file.



- Prepare the motherboard support CD or the floppy disk containing the updated motherboard BIOS before using this utility.
- Make sure that you rename the original or updated BIOS file in the floppy disk to **P5LD2VM.ROM**.

### Recovering the BIOS from a floppy disk

To recover the BIOS from a floppy disk:

1. Turn on the system.
2. Insert the floppy disk with the original or updated BIOS file to the floppy disk drive.
3. The utility displays the following message and automatically checks the floppy disk for the original or updated BIOS file.

```
Bad BIOS checksum. Starting BIOS recovery...
Checking for floppy...
```

When found, the utility reads the BIOS file and starts flashing the corrupted BIOS file.

```
Bad BIOS checksum. Starting BIOS recovery...
Checking for floppy...
Floppy found!
Reading file "P5LD2VM.ROM". Completed.
Start flashing...
```



DO NOT shut down or reset the system while updating the BIOS! Doing so can cause system boot failure!

4. Restart the system after the utility completes the updating process.

## Recovering the BIOS from the support CD

To recover the BIOS from the support CD:

1. Remove any floppy disk from the floppy disk drive, then turn on the system.
2. Insert the support CD to the optical drive.
3. The utility displays the following message and automatically checks the floppy disk for the original or updated BIOS file.

```
Bad BIOS checksum. Starting BIOS recovery...  
Checking for floppy...
```

When no floppy disk is found, the utility automatically checks the optical drive for the original or updated BIOS file. The utility then updates the corrupted BIOS file.

```
Bad BIOS checksum. Starting BIOS recovery...  
Checking for floppy...  
Floppy not found!  
Checking for CD-ROM...  
CD-ROM found!  
Reading file "P5LD2VM.ROM". Completed.  
Start flashing...
```



---

DO NOT shut down or reset the system while updating the BIOS! Doing so can cause system boot failure!

---

4. Restart the system after the utility completes the updating process.



---

The recovered BIOS may not be the latest BIOS version for this motherboard. Visit the ASUS website ([www.asus.com](http://www.asus.com)) to download the latest BIOS file.

---

## 2.1.5 ASUS Update utility

The ASUS Update is a utility that allows you to manage, save, and update the motherboard BIOS in Windows® environment. The ASUS Update utility allows you to:

- Save the current BIOS file
- Download the latest BIOS file from the Internet
- Update the BIOS from an updated BIOS file
- Update the BIOS directly from the Internet, and
- View the BIOS version information.

This utility is available in the support CD that comes with the motherboard package.



---

ASUS Update requires an Internet connection either through a network or an Internet Service Provider (ISP).

---

### Installing ASUS Update

To install ASUS Update:

1. Place the support CD in the optical drive. The **Drivers** menu appears.
2. Click the **Utilities** tab, then click **Install ASUS Update VX.XX.XX**. See page 3-4 for the **Utilities** screen menu.
3. The ASUS Update utility is copied to your system.



---

Quit all Windows® applications before you update the BIOS using this utility.

---

## Updating the BIOS through the Internet

To update the BIOS through the Internet:

1. Launch the ASUS Update utility from the Windows® desktop by clicking **Start > Programs > ASUS > ASUSUpdate > ASUSUpdate**. The ASUS Update main window appears.



2. Select **Update BIOS from the Internet** option from the drop-down menu, then click **Next**.



3. Select the ASUS FTP site nearest you to avoid network traffic, or click **Auto Select**. Click **Next**.

- From the FTP site, select the BIOS version that you wish to download. Click Next.
- Follow the screen instructions to complete the update process.



The ASUS Update utility is capable of updating itself through the Internet. Always update the utility to avail all its features.



### Updating the BIOS through a BIOS file

To update the BIOS through a BIOS file:

- Launch the ASUS Update utility from the Windows® desktop by clicking **Start > Programs > ASUS > ASUSUpdate > ASUSUpdate**. The ASUS Update main window appears.
- Select **Update BIOS from a file** option from the drop-down menu, then click **Next**.



- Locate the BIOS file from the **Open** window, then click **Save**.
- Follow the screen instructions to complete the update process.



## 2.2 BIOS setup program

This motherboard supports a programmable firmware chip that you can update using the provided utility described in section “2.1 Managing and updating your BIOS.”

Use the BIOS Setup program when you are installing a motherboard, reconfiguring your system, or prompted to “Run Setup”. This section explains how to configure your system using this utility.

Even if you are not prompted to use the Setup program, you can change the configuration of your computer in the future. For example, you can enable the security password feature or change the power management settings. This requires you to reconfigure your system using the BIOS Setup program so that the computer can recognize these changes and record them in the CMOS RAM of the firmware hub.

The firmware hub on the motherboard stores the Setup utility. When you start up the computer, the system provides you with the opportunity to run this program. Press <Del> during the Power-On-Self-Test (POST) to enter the Setup utility; otherwise, POST continues with its test routines.

If you wish to enter Setup after POST, restart the system by pressing <Ctrl+Alt+Delete>, or by pressing the reset button on the system chassis. You can also restart by turning the system off and then back on. Do this last option only if the first two failed.

The Setup program is designed to make it as easy to use as possible. Being a menu-driven program, it lets you scroll through the various sub-menus and make your selections from the available options using the navigation keys.



- 
- The default BIOS settings for this motherboard apply for most conditions to ensure optimum performance. If the system becomes unstable after changing any BIOS settings, load the default settings to ensure system compatibility and stability. Select the **Load Default Settings** item under the Exit Menu. See section “2.7 Exit Menu.”
  - The BIOS setup screens shown in this section are for reference purposes only, and may not exactly match what you see on your screen.
  - Visit the ASUS website ([www.asus.com](http://www.asus.com)) to download the latest BIOS file for this motherboard and .
-

## 2.2.1 BIOS menu screen

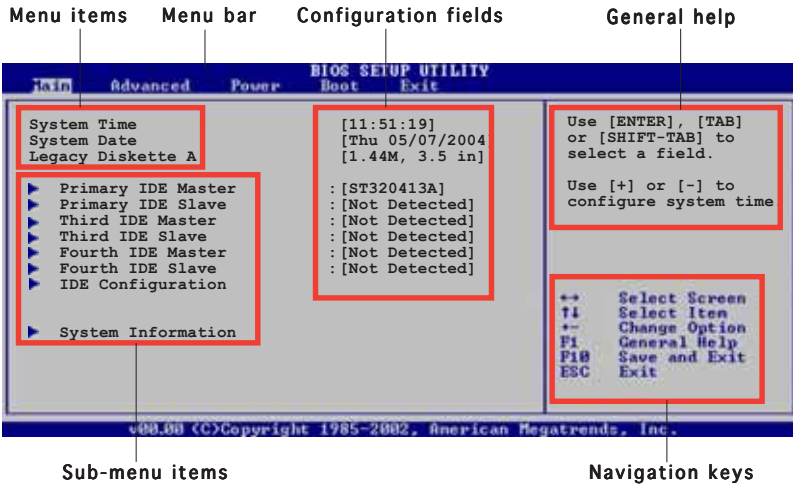

## 2.2.2 Menu bar

The menu bar on top of the screen has the following main items:

- Main** For changing the basic system configuration
- Advanced** For changing the advanced system settings
- Power** For changing the advanced power management (APM) configuration
- Boot** For changing the system boot configuration
- Exit** For selecting the exit options and loading default settings

To select an item on the menu bar, press the right or left arrow key on the keyboard until the desired item is highlighted.

## 2.2.3 Navigation keys

At the bottom right corner of a menu screen are the navigation keys for that particular menu. Use the navigation keys to select items in the menu and change the settings.



Some of the navigation keys differ from one screen to another.



## 2.2.4 Menu items

The highlighted item on the menu bar displays the specific items for that menu. For example, selecting **Main** shows the Main menu items.

The other items (Advanced, Power, Boot, and Exit) on the menu bar have their respective menu items.

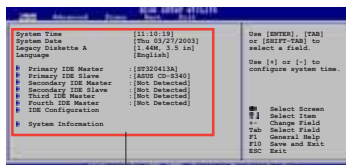

Main menu items

## 2.2.5 Sub-menu items

A solid triangle before each item on any menu screen means that the item has a sub-menu. To display the sub-menu, select the item and press <Enter>.

## 2.2.6 Configuration fields

These fields show the values for the menu items. If an item is user-configurable, you can change the value of the field opposite the item. You cannot select an item that is not user-configurable.

A configurable field is enclosed in brackets, and is highlighted when selected. To change the value of a field, select it then press <Enter> to display a list of options. Refer to “2.2.7 Pop-up window.”

## 2.2.7 Pop-up window

Select a menu item then press <Enter> to display a pop-up window with the configuration options for that item.

## 2.2.8 Scroll bar

A scroll bar appears on the right side of a menu screen when there are items that do not fit on the screen. Press the Up/Down arrow keys or <Page Up> / <Page Down> keys to display the other items on the screen.

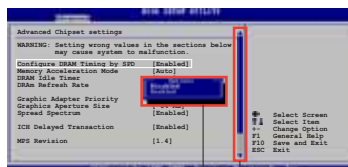

Pop-up window

Scroll bar

## 2.2.9 General help

At the top right corner of the menu screen is a brief description of the selected item.

## 2.3 Main menu

When you enter the BIOS Setup program, the Main menu screen appears, giving you an overview of the basic system information.



Refer to section “2.2.1 BIOS menu screen” for information on the menu screen items and how to navigate through them.



### 2.3.1 System Time [xx:xx:xxxx]

Allows you to set the system time.

### 2.3.2 System Date [Day xx/xx/xxxx]

Allows you to set the system date.

### 2.3.3 Legacy Diskette A [1.44M, 3.5 in.]

Sets the type of floppy drive installed. Configuration options: [Disabled] [360K, 5.25 in.] [1.2M, 5.25 in.] [720K, 3.5 in.] [1.44M, 3.5 in.] [2.88M, 3.5 in.]

### 2.3.4 Primary, Third and Fourth IDE Master/Slave

While entering Setup, the BIOS automatically detects the presence of IDE devices. There is a separate sub-menu for each IDE device. Select a device item then press <Enter> to display the IDE device information.

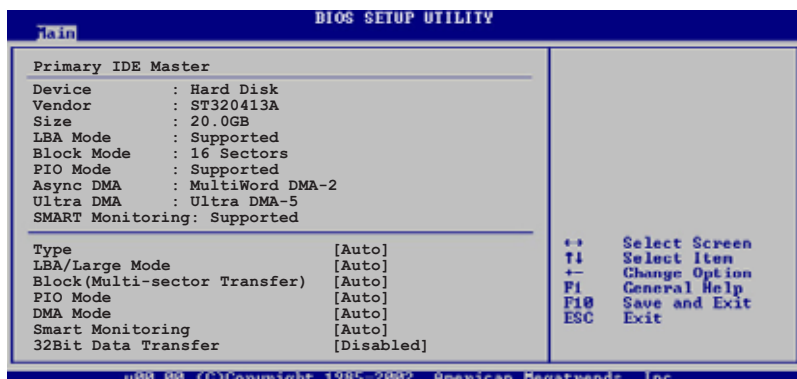

The BIOS automatically detects the values opposite the dimmed items (Device, Vendor, Size, LBA Mode, Block Mode, PIO Mode, Async DMA, Ultra DMA, and SMART monitoring). These values are not user-configurable. These items show N/A if no IDE device is installed in the system.

#### Type [Auto]

Selects the type of IDE drive. Setting to Auto allows automatic selection of the appropriate IDE device type. Select CDROM if you are specifically configuring a CD-ROM drive. Select ARMD (ATAPI Removable Media Device) if your device is either a ZIP, LS-120, or MO drive. Configuration options: [Not Installed] [Auto] [CDROM] [ARMD]

#### LBA/Large Mode [Auto]

Enables or disables the LBA mode. Setting to Auto enables the LBA mode if the device supports this mode, and if the device was not previously formatted with LBA mode disabled. Configuration options: [Disabled] [Auto]

#### Block (Multi-sector Transfer) [Auto]

Enables or disables data multi-sectors transfers. When set to Auto, the data transfer from and to the device occurs multiple sectors at a time if the device supports multi-sector transfer feature. When set to [Disabled], the data transfer from and to the device occurs one sector at a time. Configuration options: [Disabled] [Auto]

### PIO Mode [Auto]

Selects the PIO mode.

Configuration options: [Auto] [0] [1] [2] [3] [4]

### DMA Mode [Auto]

Selects the DMA mode. Configuration options: [Auto] [SWDMA0] [SWDMA1] [SWDMA2] [MWDMA0] [MWDMA1] [MWDMA2] [UDMA0] [UDMA1] [UDMA2] [UDMA3] [UDMA4] [UDMA5]

### SMART Monitoring [Auto]

Sets the Smart Monitoring, Analysis, and Reporting Technology.

Configuration options: [Auto] [Disabled] [Enabled]

### 32Bit Data Transfer [Disabled]

Enables or disables 32-bit data transfer.

Configuration options: [Disabled] [Enabled]

## 2.3.5 IDE Configuration

The items in this menu allow you to set or change the configurations for the IDE devices installed in the system. Select an item then press <Enter> if you wish to configure the item.

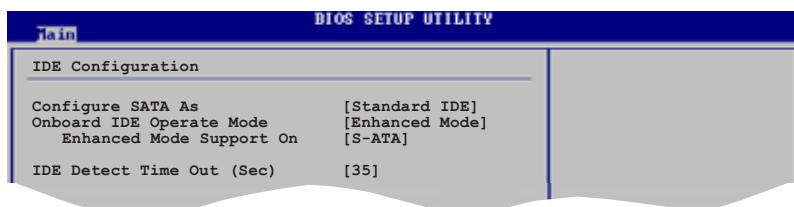

### Configure SATA As [Standard IDE]

Sets the Serial ATA configuration.

If you want to use your Serial ATA like a Parallel ATA physical storage interface, select the Standard IDE option.

Configuration options: [Standard IDE]

### Onboard IDE Operate Mode [Enhanced Mode]

Disables or allows selection of the IDE operation mode depending on the operating system (OS) that you installed. Set to Enhanced Mode if you are using native OS, such as Windows® 2000/XP/2003 Server.

Configuration options: [Disabled] [Compatible Mode] [Enhanced Mode]

Enhanced Mode Support On [S-ATA]

The default setting S-ATA allows you to use native OS on Serial ATA and Parallel ATA ports. We recommend that you do not change the default setting for better OS compatibility. In this setting, you may use legacy OS on the Parallel ATA ports **only if** you did not install any Serial ATA device.

The P-ATA+S-ATA and P-ATA options are for advanced users only. If you set to any of these options and encounter problems, revert to the default setting **S-ATA**. Configuration options: [P-ATA+S-ATA] [S-ATA] [P-ATA]

**IDE Detect Time Out [35]**

Selects the time out value for detecting ATA/ATAPI devices.  
Configuration options: [0] [5] [10] [15] [20] [25] [30] [35]

### 2.3.6 System Information

This menu gives you an overview of the general system specifications. The BIOS automatically detects the items in this menu.

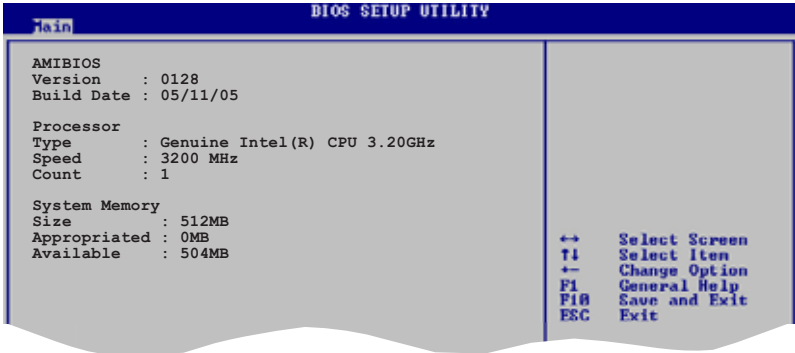

#### AMI BIOS

Displays the auto-detected BIOS information

#### Processor

Displays the auto-detected CPU specification

#### System Memory

Displays the auto-detected system memory

## 2.4 Advanced menu

The Advanced menu items allow you to change the settings for the CPU and other system devices.



Take caution when changing the settings of the Advanced menu items. Incorrect field values can cause the system to malfunction.



### 2.4.1 JumperFree Configuration

Configure System Frequency/Voltage

AI Overclocking [Auto]

Select the target CPU frequency, and the relevant parameters will be auto-adjusted. Frequencies higher than CPU manufacturer recommends are not guaranteed to be stable. If the system

#### AI Overclocking [Auto]

Allows selection of CPU overclocking options to achieve desired CPU internal frequency. Select either one of the preset overclocking configuration options:

**Manual** - allows you to individually set overclocking parameters.

**Auto** - loads the optimal settings for the system.

**Standard** - loads the standard settings for the system.

**Overclock Profile** - loads overclocking profiles with optimal parameters for stability when overclocking.



The following item appears only when you set the **AI Overclocking** item to [Manual].

## CPU Frequency [XXX]

Displays the frequency sent by the clock generator to the system bus and PCI bus. The value of this item is auto-detected by the BIOS. Use the <+> and <-> keys to adjust the CPU frequency. You can also type the desired CPU frequency using the numeric keypad. The values range from 100 to 400. Refer to the table below for the correct Front Side Bus and CPU External Frequency settings.

### FSB/CPU External Frequency Synchronization

Front Side Bus	CPU External Frequency
FSB 1066	266 MHz
FSB 800	200 MHz
FSB 533	133 MHz

## DRAM Frequency [Auto]

Allows you to set the DDR2 operating frequency.

Configuration options: [Auto] [DDR2-400MHz] [DDR2-533MHz] [DDR-667MHz]



Selecting a very high DRAM frequency may cause the system to become unstable! If this happens, revert to the default setting.

## PCI Express Frequency [Auto]

Allows you to set the PCI Express frequency. This item is set to [Auto] by default. Configuration options: [Auto] [90]...[150]

## PCI Clock Synchronization Mode [To PCI Express]

Allows you to synchronize the PCI frequency with the PCI Express or CPU frequency. Configuration options: [To PCI Express] [Fixed 33.3MHz] [Fixed 36.3MHz] [Fixed 40.0MHz]

## Memory Voltage [Auto]

Allows you to select the DDR2 reference voltage.

Configuration options: [Auto] [1.812V] [1.904V]



Refer to the DDR2 documentation before adjusting the memory voltage. Setting a very high memory voltage may damage the memory module(s)!



## MCH Chipset Voltage [Auto]

Allows you to select the memory controller hub (MCH) voltage.

Configuration options: [Auto] [1.50V] [1.60V] [1.70V]

## CPU VCore Voltage [Auto]

Sets the operating VCore voltage. Configuration options: [Auto]

[1.7000V] [1.6875V] [1.6750V] [1.6625V] [1.6500V] [1.6375V]  
[1.6250V] [1.6125V] [1.6000V] [1.5875V] [1.5750V] [1.5625V]  
[1.5500V] [1.5375V] [1.5250V] [1.5125V] [1.5000V] [1.4875V]  
[1.4750V] [1.4625V] [1.4500V] [1.4375V] [1.4250V] [1.4125V]  
[1.4000V] [1.3875V] [1.3750V] [1.3625V] [1.3500V] [1.3375V]  
[1.3250V] [1.3125V] [1.3000V] [1.2875V]



- Setting to a very high CPU VCore voltage can damage the CPU or may cause the system to become unstable. If this happens, revert to default settings.
- The following item appears only when the **AI Overclocking** item is set to [Overclock Profile].

## Overclock Options [Overclock 5%]

Allows you to overclock the CPU speed through the available preset values.

Configuration options: [Overclock 5%] [Overclock 10%] [Overclock 15%]  
[Overclock 20%] [Overclock 30%]

## 2.4.2 USB Configuration

The items in this menu allows you to change the USB-related features. Select an item then press <Enter> to display the configuration options.

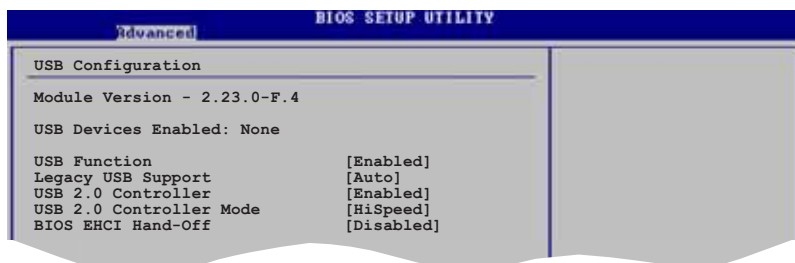

The Module Version and USB Devices Enabled items show the auto-detected values. If no USB device is detected, the item shows None.

### USB Function [Enabled]

Allows you to enable or disable the USB function.

Configuration options: [Disabled] [Enabled]

### Legacy USB Support [Auto]

Allows you to enable or disable support for USB devices on legacy operating systems (OS). Setting to Auto allows the system to detect the presence of USB devices at startup. If detected, the USB controller legacy mode is enabled. If no USB device is detected, the legacy USB support is disabled. Configuration options: [Disabled] [Enabled] [Auto]

### USB 2.0 Controller [Enabled]

Allows you to enable or disable the USB 2.0 controller.

Configuration options: [Disabled] [Enabled]

### USB 2.0 Controller Mode [HiSpeed]

Allows you to configure the USB 2.0 controller in HiSpeed (480 Mbps) or Full Speed (12 Mbps). Configuration options: [HiSpeed] [Full Speed]

### BIOS EHCI Hand-off [Disabled]

Allows you to enable support for operating systems without an EHCI hand-off feature. Configuration options: [Enabled] [Disabled]



Do not disable the BIOS EHCI Hand-Off option if you are running a Windows® operating system with USB device.

## 2.4.3 CPU Configuration

The items in this menu show the CPU-related information that the BIOS automatically detects.

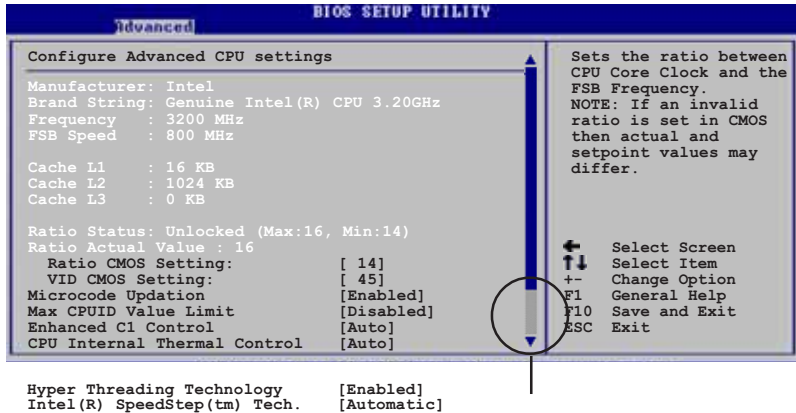

### CPU Lock Free [Auto]

Allows you to adjust the CPU multiplier to 14x. Setting this item to [Auto] allows the motherboard to automatically reduce the CPU multiplier value for more flexibility when increasing the external FSB. This item appears only when you install a processor with CPU Lock Free feature.

Configuration options: [Auto] [Disabled] [Enabled]

### Ratio CMOS Setting [ 14]

Sets the ratio between the CPU Core Clock and the Front Side Bus frequency. The default value of this item is auto-detected by BIOS. Use the <+> or <-> keys to adjust the values.

### VID CMOS Setting [ 45]

Allows you to set the VID CMOS setting at which the processor is to run. The BIOS auto-detects the default value of this item. Use the <+> or <-> keys to adjust the values.

### Microcode Updation [Enabled]

Allows you to enable or disable the microcode updation.

Configuration options: [Disabled] [Enabled]

### Max CPUID Value Limit [Disabled]

Enable this item to boot legacy operating systems that cannot support CPUs with extended CPUID functions.

Configuration options: [Disabled] [Enabled]

### Execute Disable Function [Disabled]

Enables or disables the Execute Disable function. This item appears only when you install a processor with the Execute Disable function.

Configuration options: [Disabled] [Enabled]

### Enhanced C1 Control [Auto]

When set to [Auto], the BIOS will automatically check the CPU's capability to enable the C1E support. In C1E mode, the CPU power consumption is lower when idle. Configuration options: [Auto] [Disabled]

### CPU Internal Thermal Control [Auto]

Disables or sets the CPU internal thermal control.

Configuration options: [Disabled] [Auto]

### Hyper-Threading Technology [Enabled]

Allows you to enable or disable the processor Hyper-Threading Technology.

Configuration options: [Disabled] [Enabled]



---

The following item appears only when you installed an Intel® Pentium® D or Intel® Pentium® 4 CPU that supports the Enhanced Intel SpeedStep® Technology (EIST).

---

### Intel(R) SpeedStep Technology [Automatic]

Allows you to use the Enhanced Intel SpeedStep® Technology. When set to [Automatic], you can adjust the system power settings in the operating system to use the EIST feature.

Set this item to [Maximum] or [Disabled] if you do not want to use the EIST. The CPU constantly operates at a lower internal frequency when you set this item to [Minimum].

Configuration options: [Maximum] [Minimum] [Automatic] [Disabled]



- 
- Refer to the Appendix for details on how to use the EIST feature.
  - The motherboard comes with a BIOS file that supports EIST.
-

## 2.4.4 Chipset

The Chipset menu allows you to change the advanced chipset settings. Select an item then press <Enter> to display the sub-menu.

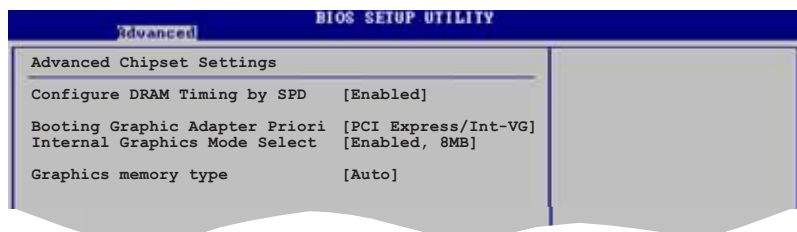

### Advanced Chipset Settings

#### Configure DRAM Timing by SPD [Enabled]

When this item is enabled, the DRAM timing parameters are set according to the DRAM SPD (Serial Presence Detect). When disabled, you can manually set the DRAM timing parameters through the DRAM sub-items. The following sub-items appear when this item is Disabled.

Configuration options: [Disabled] [Enabled]

##### DRAM CAS# Latency [5 Clocks]

Controls the latency between the SDRAM read command and the time the data actually becomes available.

Configuration options: [6 Clocks] [5 Clocks] [4 Clocks] [3 Clocks]

##### DRAM RAS# Precharge [4 Clocks]

Controls the idle clocks after issuing a precharge command to the DDR SDRAM. Configuration options: [2 Clocks] [3 Clocks] [4 Clocks]

[5 Clocks] [6 Clocks]

##### DRAM RAS# to CAS# Delay [4 Clocks]

Controls the latency between the DDR SDRAM active command and the read/write command. Configuration options: [2 Clocks] [3 Clocks]

[4 Clocks] [5 Clocks] [6 Clocks]

##### DRAM RAS# Activate to Precharge [15 Clocks]

Sets the RAS Activate timing to Precharge timing.

Configuration options: [1 Clock] [2 Clocks] ~ [18 Clocks]

##### DRAM Write Recovery Time [4 Clocks]

Sets the DRAM Write Recover Time.

Configuration options: [2 Clocks] [3 Clocks] [4 Clocks] [5 Clocks]

[6 Clocks]

### **Booting Graphic Adapter Priority [PCI Express/Int-VGA]**

Allows selection of the graphics controller to use as primary boot device.  
Configuration options: [Internal VGA] [PCI Express/Int-VGA]  
[PCI Express/PCI] [PCI/PCI Express] [PCI/Int-VGA]

### **Internal Graphics Mode Select [Enabled, 8MB]**

Sets the internal graphics mode.  
Configuration options: [Disabled] [Enabled, 1MB] [Enabled, 8MB]

### **Graphics memory type [Auto]**

Sets the graphics memory type. Configuration options: [Auto] [DVMT]  
[FIX] [DVMT+FIX]

## **2.4.5 Onboard Devices Configuration**

#### **Configure Win627EHF Super IO Chipset**

HD Audio Controller	[Enabled]
Onboard PCIEX GbE LAN	[Enabled]
LAN Option ROM	[Disabled]
ITE8211F Controller	[Enabled]
Detecting Device Time	[Quick Mode]
Serial Port1 Address	[3F8/IRQ4]
Parallel Port Address	[378]
Parallel Port Mode	[ECP]
ECP Mode DMA Channel	[DMA3]
Parallel Port IRQ	[IRQ7]

### **HD Audio Controller [Enabled]**

Enables or disables the Azalia/AC'97 CODEC.  
Configuration options: [Enabled] [Disabled]

### **OnBoard PCIEX GbE LAN [Enabled]**

Allows you to enable or disable the onboard PCI Express Gigabit LAN controller. Configuration options: [Disabled] [Enabled]

#### LAN Option ROM [Disabled]

Allows you to enable or disable the option ROM in the onboard LAN controller. This item appears only when the Onboard LAN item is set to Enabled. Configuration options: [Disabled] [Enabled]

## ITE8211F Controller [Enabled]

Enables or disables the onboard ITE® 8211F IDE controller.

Configuration options: [Enabled] [Disabled]

### *Detecting Device Time [Quick Mode]*

Sets the ITE8211F detecting device time. If the devices installed on the ITE IDE connector cannot be detected, set this item to Standard Mode to enable complete detecting process. This item appears only when the ITE8211F Controller is Enabled.

Configuration options: [Standard Mode] [Quick Mode]

## Serial Port1 Address [3F8/IRQ4]

Allows you to select the Serial Port1 base address.

Configuration options: [Disabled] [3F8/IRQ4] [2F8/IRQ3] [3E8/IRQ4] [2E8/IRQ3]

## Parallel Port Address [378]

Allows you to select the Parallel Port base addresses.

Configuration options: [Disabled] [378] [278] [3BC]

## Parallel Port Mode [ECP]

Allows you to select the Parallel Port mode.

Configuration options: [Normal] [Bi-directional] [EPP] [ECP]

### **ECP Mode DMA Channel [DMA3]**

Appears only when the Parallel Port Mode is set to [ECP]. This item allows you to set the Parallel Port ECP DMA.

Configuration options: [DMA0] [DMA1] [DMA3]

### **EPP Version [1.9]**

Allows selection of the Parallel Port EPP version. This item appears only when the **Parallel Port Mode** is set to **EPP**.

Configuration options: [1.9] [1.7]

### *Parallel Port IRQ [IRQ7]*

Configuration options: [IRQ5] [IRQ7]

## 2.4.6 PCI PnP

The PCI PnP menu items allow you to change the advanced settings for PCI/PnP devices. The menu includes setting IRQ and DMA channel resources for either PCI/PnP or legacy ISA devices, and setting the memory size block for legacy ISA devices.



Take caution when changing the settings of the PCI PnP menu items. Incorrect field values can cause the system to malfunction.



### Plug and Play O/S [No]

When set to [No], BIOS configures all the devices in the system. When set to [Yes] and if you install a Plug and Play operating system, the operating system configures the Plug and Play devices not required for boot. Configuration options: [No] [Yes]

### PCI Latency Timer [64]

Allows you to select the value in units of PCI clocks for the PCI device latency timer register. Configuration options: [32] [64] [96] [128] [160] [192] [224] [248]

### Allocate IRQ to PCI VGA [Yes]

When set to [Yes], BIOS assigns an IRQ to PCI VGA card if the card requests for an IRQ. When set to [No], BIOS does not assign an IRQ to the PCI VGA card even if requested. Configuration options: [No] [Yes]

### Palette Snooping [Disabled]

When set to [Enabled], the palette snooping feature informs the PCI devices that an ISA graphics device is installed in the system so that the latter can function correctly. Configuration options: [Disabled] [Enabled]



## IRQ-xx assigned to [PCI Device]

When set to [PCI Device], the specific IRQ is free for use of PCI/PnP devices. When set to [Reserved], the IRQ is reserved for legacy ISA devices. Configuration options: [PCI Device] [Reserved]

## 2.5 Power menu

The Power menu items allow you to change the settings for the Advanced Configuration and Power Interface (ACPI) and the Advanced Power Management (APM). Select an item then press <Enter> to display the configuration options.

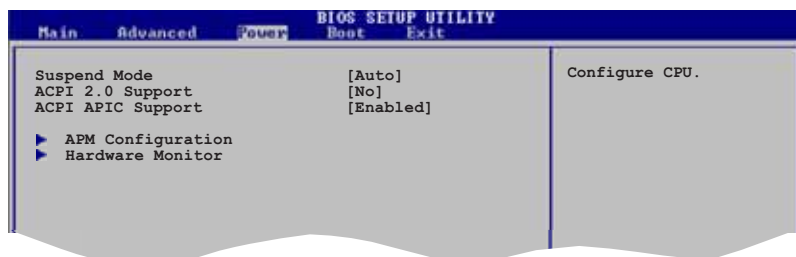

### 2.5.1 Suspend Mode [Auto]

Allows you to select the Advanced Configuration and Power Interface (ACPI) state to be used for system suspend.

Configuration options: [S1 (POS) Only] [S3 Only] [Auto]

### 2.5.2 ACPI 2.0 Support [No]

Allows you to add more tables for Advanced Configuration and Power Interface (ACPI) 2.0 specifications. Configuration options: [No] [Yes]

### 2.5.3 ACPI APIC Support [Enabled]

Allows you to enable or disable the Advanced Configuration and Power Interface (ACPI) support in the Application-Specific Integrated Circuit (ASIC). When set to Enabled, the ACPI APIC table pointer is included in the RSDT pointer list. Configuration options: [Disabled] [Enabled]

## 2.5.4 APM Configuration

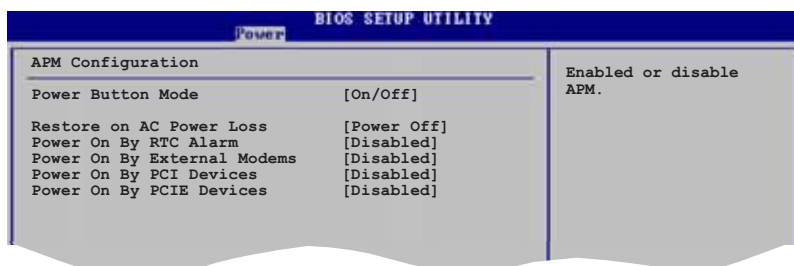

### Power Button Mode [On/Off]

Allows the system to go into On/Off mode or suspend mode when the power button is pressed. Configuration options: [On/Off] [Suspend]

### Restore on AC Power Loss [Power Off]

When set to Power Off, the system goes into off state after an AC power loss. When set to Power On, the system goes on after an AC power loss. When set to Last State, the system goes into either off or on state, whatever the system state was before the AC power loss. Configuration options: [Power Off] [Power On] [Last State]

### Power On By RTC Alarm [Disabled]

Allows you to enable or disable RTC to generate a wake event. When this item is set to Enabled, the items RTC Alarm Date, RTC Alarm Hour, RTC Alarm Minute, and RTC Alarm Second appear with set values. Configuration options: [Disabled] [Enabled]

### Power On By External Modems [Disabled]

This allows either settings of [Enabled] or [Disabled] for powering up the computer when the external modem receives a call while the computer is in Soft-off mode. Configuration options: [Disabled] [Enabled]



---

The computer cannot receive or transmit data until the computer and applications are fully running. Thus, connection cannot be made on the first try. Turning an external modem off and then back on while the computer is off causes an initialization string that turns the system power on.

---

### **Power On By PCI Devices [Disabled]**

When set to [Enabled], this parameter allows you to turn on the system through a PCI LAN or modem card. This feature requires an ATX power supply that provides at least 1A on the +5VSB lead.

Configuration options: [Disabled] [Enabled]

### **Power On By PCIE Devices [Disabled]**

When set to [Enabled], this parameter allows you to turn on the system through a PCI Express LAN card. This feature requires an ATX power supply that provides at least 1A on the +5VSB lead.

Configuration options: [Disabled] [Enabled]

## 2.5.5 Hardware Monitor

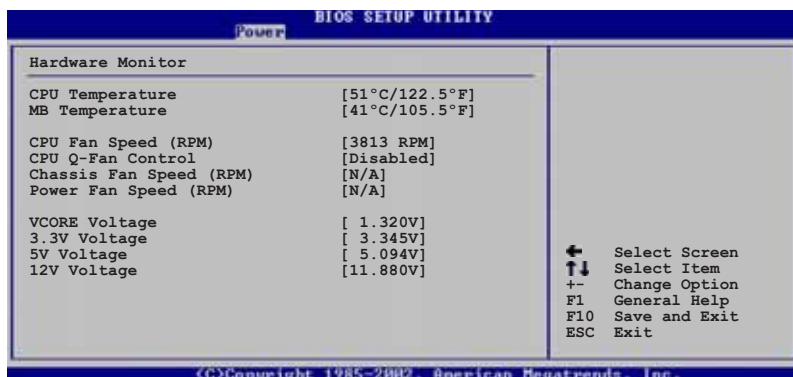

### CPU Temperature [xxxC/xxxF]

### MB Temperature [xxxC/xxxF]

The onboard hardware monitor automatically detects and displays the motherboard and CPU temperatures. Select [Ignored] if you do not wish to display the detected temperatures.

Configuration options: [Ignored] [xxxC/xxxF]

### CPU Fan Speed [xxxxRPM] or [N/A]

The onboard hardware monitor automatically detects and displays the CPU fan speed in rotations per minute (RPM). If the fan is not connected to the motherboard, the field shows N/A.

Configuration options: [Ignored] [xxxRPM]

### CPU Q-Fan Control [Disabled]

Allows you to enable or disable the ASUS Q-Fan feature that smartly adjusts the fan speeds for more efficient system operation.

Configuration options: [Disabled] [Enabled]



---

The **CPU FAN PROFILE MODE** item appears when you enable the **CPU Q-Fan Control** feature.

---

### CPU FAN PROFILE MODE [Optimal]

Sets the CPU fan profile mode.

Configuration options: [Optimal] [Silent Mode] [Performance Mode]

### **Chassis Fan Speed [xxxxRPM] or [N/A]**

The onboard hardware monitor automatically detects and displays the chassis fan speed in rotations per minute (RPM). If the fan is not connected to the chassis, the specific field shows N/A.

Configuration options: [Ignored] [xxxRPM] or [N/A]

### **Power Fan Speed [xxxxRPM] or [N/A]**

The onboard hardware monitor automatically detects and displays the power fan speed in rotations per minute (RPM). If the fan is not connected to the power fan connector, the specific field shows N/A.

Configuration options: [Ignored] [xxxRPM] or [N/A]

### **VCORE Voltage, 3.3V Voltage, 5V Voltage, 12V Voltage**

The onboard hardware monitor automatically detects the voltage output through the onboard voltage regulators.

## 2.6 Boot menu

The Boot menu items allow you to change the system boot options. Select an item then press <Enter> to display the sub-menu.

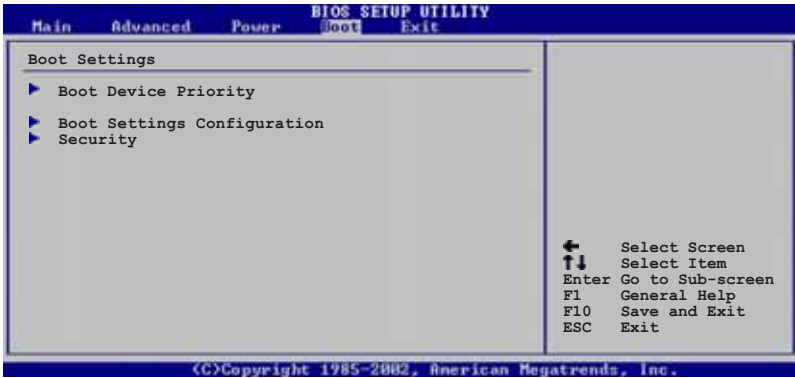

### 2.6.1 Boot Device Priority

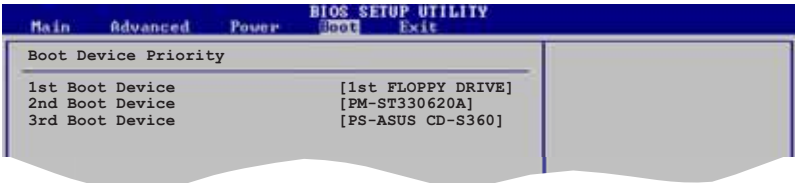

#### 1st ~ xxth Boot Device [1st Floppy Drive]

These items specify the boot device priority sequence from the available devices. The number of device items that appears on the screen depends on the number of devices installed in the system.

Configuration options: [xxxxx Drive] [Disabled]

## 2.6.2 Boot Settings Configuration

BIOS SETUP UTILITY	
Boot	
Boot Settings Configuration	
Quick Boot	[Enabled]
Full Screen Logo	[Enabled]
AddOn ROM Display Mode	[Force BIOS]
Bootup Num-Lock	[On]
PS/2 Mouse Support	[Auto]
Wait For 'F1' If Error	[Enabled]
Hit 'DEL' Message Display	[Enabled]
Interrupt 19 Capture	[Disabled]

Allows BIOS to skip certain tests while booting. This will decrease the time needed to boot the system.

### Quick Boot [Enabled]

Enabling this item allows the BIOS to skip some power on self tests (POST) while booting to decrease the time needed to boot the system. When set to [Disabled], BIOS performs all the POST items.

Configuration options: [Disabled] [Enabled]

### Full Screen Logo [Enabled]

This allows you to enable or disable the full screen logo display feature.

Configuration options: [Disabled] [Enabled]



Set this item to [Enabled] to use the ASUS MyLogo2™ feature.

### Add On ROM Display Mode [Force BIOS]

Sets the display mode for option ROM.

Configuration options: [Force BIOS] [Keep Current]

### Bootup Num-Lock [On]

Allows you to select the power-on state for the NumLock.

Configuration options: [Off] [On]

### PS/2 Mouse Support [Auto]

Allows you to enable or disable support for PS/2 mouse.

Configuration options: [Disabled] [Enabled] [Auto]

### Wait for 'F1' If Error [Enabled]

When set to Enabled, the system waits for the F1 key to be pressed when error occurs. Configuration options: [Disabled] [Enabled]

### Hit 'DEL' Message Display [Enabled]

When set to Enabled, the system displays the message "Press DEL to run Setup" during POST. Configuration options: [Disabled] [Enabled]

## Interrupt 19 Capture [Disabled]

When set to [Enabled], this function allows the option ROMs to trap Interrupt 19. Configuration options: [Disabled] [Enabled]

### 2.6.3 Security

The Security menu items allow you to change the system security settings. Select an item then press <Enter> to display the configuration options.

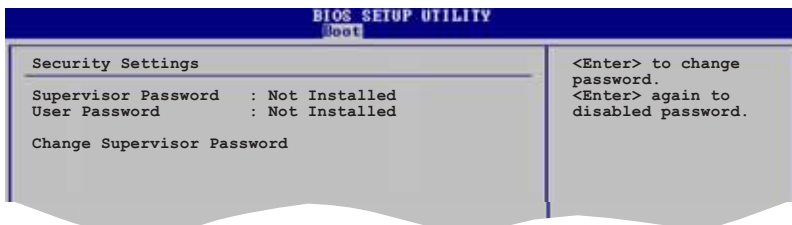

### Change Supervisor Password

Select this item to set or change the supervisor password. The Supervisor Password item on top of the screen shows the default **Not Installed**. After you set a password, this item shows **Installed**.

To set a Supervisor Password:

1. Select the Change Supervisor Password item and press <Enter>.
2. From the password box, type a password composed of at least six letters and/or numbers, then press <Enter>.
3. Confirm the password when prompted.

The message "Password Installed" appears after you successfully set your password.

To change the supervisor password, follow the same steps as in setting a user password.

To clear the supervisor password, select the Change Supervisor Password then press <Enter>. The message "Password Uninstalled" appears.



---

If you forget your BIOS password, you can clear it by erasing the CMOS Real Time Clock (RTC) RAM. See section "2.6 Jumpers" for information on how to erase the RTC RAM.

---



After you have set a supervisor password, the other items appear to allow you to change other security settings.

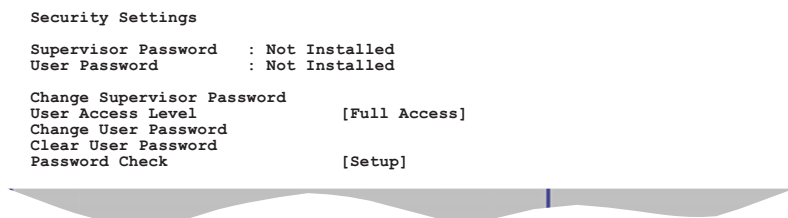

## User Access Level (Full Access)

This item allows you to select the access restriction to the Setup items. Configuration options: [No Access] [View Only] [Limited] [Full Access]

**No Access** prevents user access to the Setup utility.

**View Only** allows access but does not allow change to any field.

**Limited** allows changes only to selected fields, such as Date and Time.

**Full Access** allows viewing and changing all the fields in the Setup utility.

## Change User Password

Select this item to set or change the user password. The User Password item on top of the screen shows the default **Not Installed**. After you set a password, this item shows **Installed**.

To set a User Password:

1. Select the Change User Password item and press <Enter>.
2. On the password box that appears, type a password composed of at least six letters and/or numbers, then press <Enter>.
3. Confirm the password when prompted.

The message "Password Installed" appears after you set your password successfully.

To change the user password, follow the same steps as in setting a user password.

## Clear User Password

Select this item to clear the user password.

## Password Check [Setup]

When set to [Setup], BIOS checks for user password when accessing the Setup utility. When set to [Always], BIOS checks for user password both when accessing Setup and booting the system.

Configuration options: [Setup] [Always]

## 2.7 Exit menu

The Exit menu items allow you to load the optimal or failsafe default values for the BIOS items, and save or discard your changes to the BIOS items.



Pressing <Esc> does not immediately exit this menu. Select one of the options from this menu or <F10> from the legend bar to exit.

### Exit & Save Changes

Once you are finished making your selections, choose this option from the Exit menu to ensure the values you selected are saved to the CMOS RAM. An onboard backup battery sustains the CMOS RAM so it stays on even when the PC is turned off. When you select this option, a confirmation window appears. Select **Ok** to save changes and exit.



If you attempt to exit the Setup program without saving your changes, the program prompts you with a message asking if you want to save your changes before exiting. Press <Enter> to save the changes while exiting.

## Exit & Discard Changes

Select this option only if you do not want to save the changes that you made to the Setup program. If you made changes to fields other than System Date, System Time, and Password, the BIOS asks for a confirmation before exiting.

## Discard Changes

This option allows you to discard the selections you made and restore the previously saved values. After selecting this option, a confirmation appears. Select **Ok** to discard any changes and load the previously saved values.

## Load Setup Defaults

This option allows you to load the default values for each of the parameters on the Setup menus. When you select this option or if you press <F5>, a confirmation window appears. Select **Ok** to load default values. Select **Exit & Save Changes** or make other changes before saving the values to the non-volatile RAM.



This chapter describes the contents of the support CD that comes with the motherboard package.

# Software support

A large, light gray, stylized number '3' is positioned behind the text 'Software support', partially overlapping it.

### 3.1 Installing an operating system

This motherboard supports Windows® 2000/XP/2003 Server operating systems (OS). Always install the latest OS version and corresponding updates to maximize the features of your hardware.



- Motherboard settings and hardware options vary. Use the setup procedures presented in this chapter for reference only. Refer to your OS documentation for detailed information.
- Make sure that you install Windows® 2000 Service Pack 4 or the Windows® XP Service Pack 1 or later versions before installing the drivers for better compatibility and system stability.

### 3.2 Support CD information

The support CD that came with the motherboard package contains the drivers, software applications, and utilities that you can install to avail all motherboard features.



The contents of the support CD are subject to change at any time without notice. Visit the ASUS website(www.asus.com) for updates.

#### 3.2.1 Running the support CD

Place the support CD to the optical drive. The CD automatically displays the **Drivers** menu if Autorun is enabled in your computer.

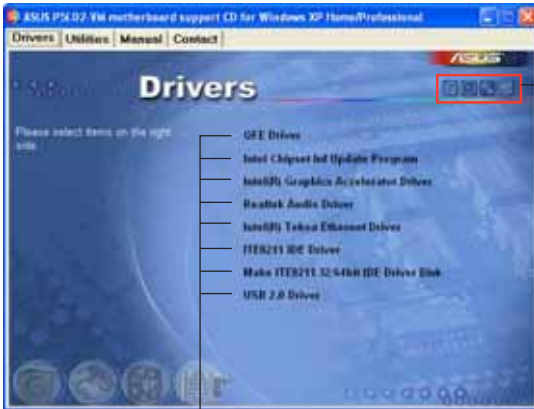

Click an icon to display support CD/motherboard information

Click an item to install



If **Autorun** is NOT enabled in your computer, browse the contents of the support CD to locate the file **ASSETUP.EXE** from the **BIN** folder. Double-click the **ASSETUP.EXE** to run the CD.

### 3.2.2 Drivers menu

The drivers menu shows the available device drivers if the system detects installed devices. Install the necessary drivers to activate the devices.

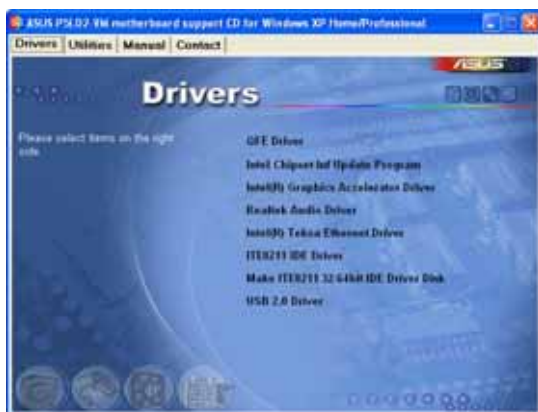

#### QFE Update

Installs the Windows® XP Service Pack 1 component update for the USB 1.1/2.0 drivers. Install this update before you install the Intel® Chipset Inf Update Program.

#### Intel Chipset Inf Update Program

This item installs the Intel® Chipset INF Update Program. This driver enables Plug-n-Play INF support for the Intel® chipset components on the motherboard. When installed to the target system, this driver provides the method for configuring the chipset components.

You can install this utility using three different modes: interactive, silent, or unattended preload. Installing the driver in interactive mode requires user input during installation. User input is not required when installing the driver in silent or unattended preload modes. Refer to the online help or readme file that came with the utility for details.

#### Intel(R) Graphics Accelerator Driver

Installs the Intel® Graphics Accelerator driver.

#### Realtek Audio Driver

Installs the Realtek® ALC882 high-definition audio driver and application.

#### Intel(R) Tekoa Ethernet Driver

Installs the Intel® Tekoa Ethernet driver.

### ITE8211 IDE Driver

Installs the IT8211 IDE drivers.

### Make ITE8211 32/64 bit IDE Driver Disk

Installs the IT8211 driver disk for 32-bit or 64-bit operating systems.

### USB 2.0 Driver

Installs the USB 2.0 driver.

## 3.2.3 Utilities menu

The Utilities menu shows the applications and other software that the motherboard supports.



### ASUS PC Probe II

This smart utility monitors the fan speed, CPU temperature, and system voltages, and alerts you of any detected problems. This utility helps you keep your computer in healthy operating condition.

### ASUS Update

The ASUS Update utility allows you to update the motherboard BIOS in a Windows® environment. This utility requires an Internet connection either through a network or an Internet Service Provider (ISP). See page 2-8 for details.

### ASUS Screen Saver

Installs the ASUS screen saver.



## ADOBE Acrobat Reader V5.0

Installs the Adobe® Acrobat® Reader V5.0.

## Microsoft DirectX 9.0c

Installs the Microsoft® DirectX 9.0c driver.

## Anti-Virus Utility

Installs the PC-cillin anti-virus program. View the online help for detailed information.

### 3.2.4 Manuals menu

The Manuals menu contains a list of supplementary user manuals. Click an item to open the folder of the user manual.



---

Most user manual files are in Portable Document Format (PDF). Install the Adobe® Acrobat® Reader from the **Utilities menu** before opening a user manual file.

---



### 3.2.5 ASUS Contact information

Click the **Contact** tab to display the ASUS contact information. You can also find this information on the inside front cover of this user guide.

