

CdS photoconductive cell Metal package type

Hermetically sealed for high reliability

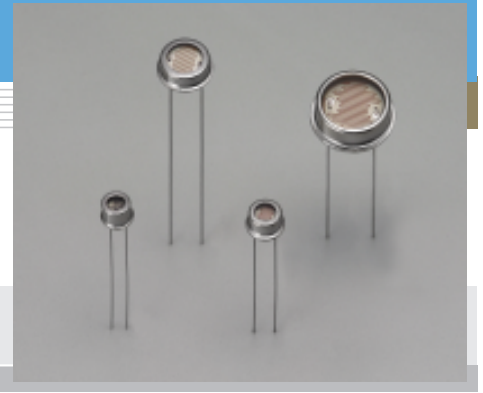

CdS photoconductive cells utilize photoconductive effects in semiconductors that decrease their resistance when illuminated by light. These sensors are non-polar resistive elements with spectral response characteristics close to the human eye (luminous efficiency), thus making their operating circuits simple and small.

Features

- Variety of package size
- Highly resistant to moisture and dust

Applications

- Sensor for office machine
- Safety device for heating system and boiler (flame monitor for oil burner)
- Night/day check sensor and sunlight sensor for air conditioner
- Alarm and safety sensor

■ Absolute maximum ratings / Characteristics (Typ. Ta=25 °C, unless otherwise noted)

Type No.	Dimensional outline	Absolute maximum ratings			Characteristics *1							
		Supply voltage (Vdc)	Power dissipation P (mW)	Ambient temperature Ta (°C)	Peak sensitivity wavelength λp (nm)	Resistance *2			γ ₁₀ ¹⁰⁰ *4	Response time 10 lx *5		
						10 lx, 2856 K	0 lx *3	Min. (kΩ)		Max. (kΩ)	Min. (MΩ)	Rise time tr (ms)
5M type (TO-18)												
P1114-01	①	100	30	-30 to +50	630	13	39	1	0.80	60	25	
P1114-04					570	15	45	10		40	20	
6M type (φ5.5)												
P930	②	150	50	-30 to +70	560	7	23	0.5	0.68	60	90	
8M type (TO-5)												
P201B	③	200	100	-30 to +50	560	21	63	20	0.85	25	20	
P201D				-30 to +60	520	20	60	10	0.90	30	10	
P368			50	-30 to +50	620	14	43	20	0.85	35	20	
P380				-30 to +50	620	4.4	13					
P467			100	100	-30 to +60	520	8	24	5	0.90	50	20
P534					-30 to +80	560	1.3	3.7	0.05	0.55	70	100
12M type (TO-8)												
P621	④	150	300	-30 to +60	570	1.3	3.7	0.3	0.75	80	40	
P3872		400			540	5	15	1.0	0.80	40	30	

*1: All characteristics are measured after exposure to light (100 to 500 lx) for one to two hours.

*2: The light source is a standard tungsten lamp operated at a color temperature of 2856 K.

*3: Measured 10 seconds after removal of light of 10 lx.

*4: Typical gamma characteristics (within ±0.10 variations) between 100 lx to 10 lx

$$\gamma_{10}^{100} = \frac{|\log(R_{100}) - \log(R_{10})|}{|\log(E_{100}) - \log(E_{10})|}$$

E₁₀₀, E₁₀: illuminance 100 lx, 10 lx

R₁₀₀, R₁₀: resistance at 100 lx and 10 lx respectively

*5: The rise time is the time required for the sensor resistance to reach 63 % of the saturated conductance level (resistance when fully illuminated). The fall time is the time required for the sensor resistance to decay from the saturated conductance level to 37 %.

CdS photoconductive cell Metal package type

Dimensional outlines (unit: mm)

① 5M type (TO-18)

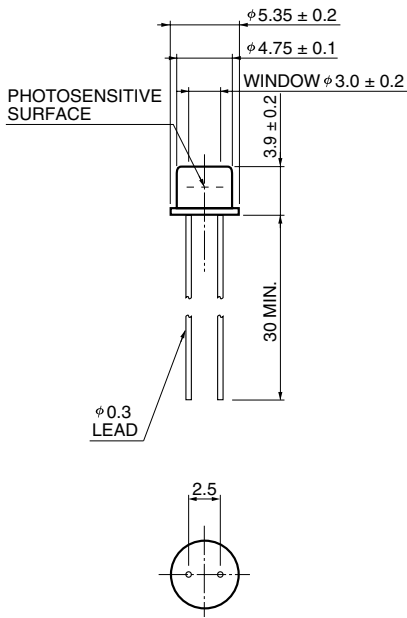

KCDSA0007EB

② 6M type

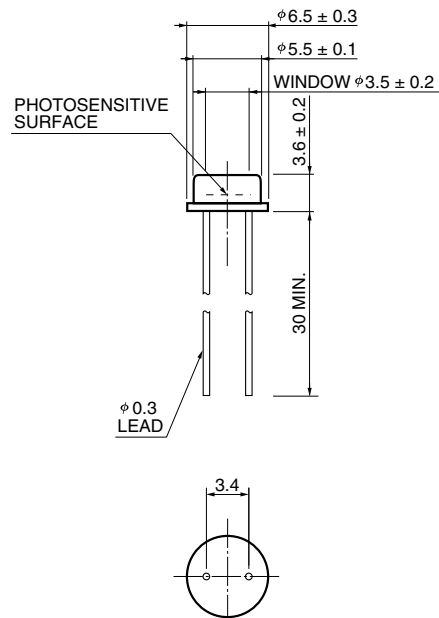

KCDSA0008EA

③ 8M type (TO-5)

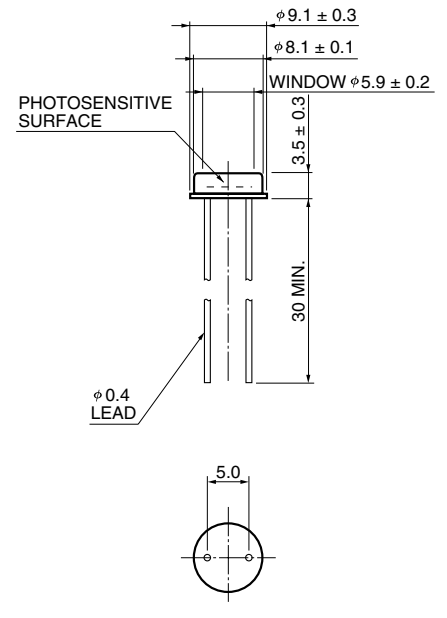

KCDSA0009EB

④ 12M type (TO-8)

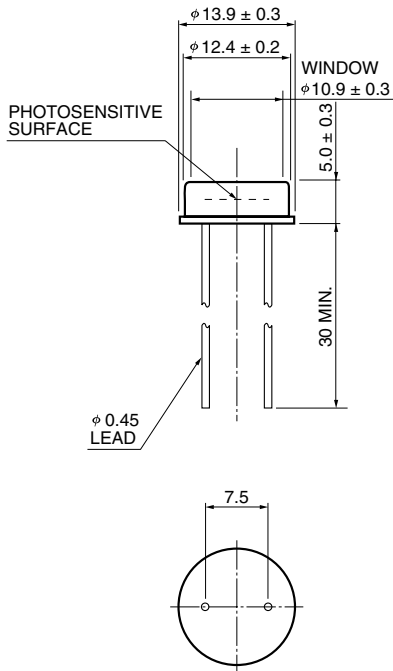

KCDSA0010EA

Resistance vs. illuminance

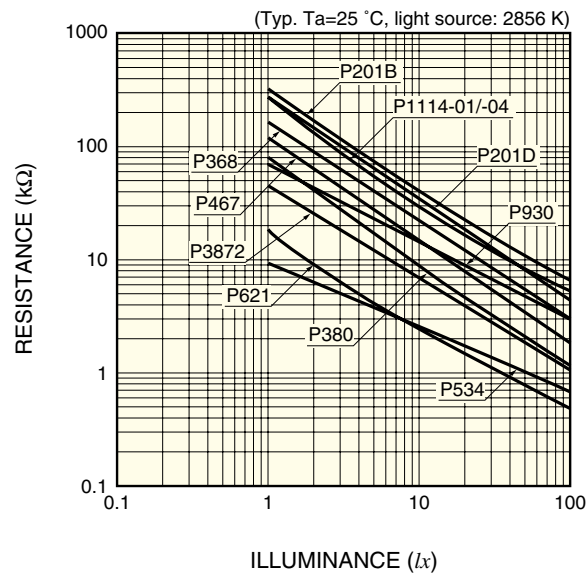

KCDSB0022EB

HAMAMATSU

Information furnished by HAMAMATSU is believed to be reliable. However, no responsibility is assumed for possible inaccuracies or omissions. Specifications are subject to change without notice. No patent rights are granted to any of the circuits described herein. ©2003 Hamamatsu Photonics K.K.

HAMAMATSU PHOTONICS K.K., Solid State Division

1126-1 Ichino-cho, Hamamatsu City, 435-8558 Japan, Telephone: (81) 053-434-3311, Fax: (81) 053-434-5184, <http://www.hamamatsu.com>

U.S.A.: Hamamatsu Corporation: 360 Foothill Road, P.O.Box 6910, Bridgewater, N.J. 08807-0910, U.S.A., Telephone: (1) 908-231-0960, Fax: (1) 908-231-1218

Germany: Hamamatsu Photonics Deutschland GmbH: Arzbergerstr. 10, D-82211 Herrsching am Ammersee, Germany, Telephone: (49) 08152-3750, Fax: (49) 08152-2658

France: Hamamatsu Photonics France S.A.R.L.: 8, Rue du Saule Trapu, Parc du Moulin de Massy, 91882 Massy Cedex, France, Telephone: 33-(1) 69 53 71 00, Fax: 33-(1) 69 53 71 10

United Kingdom: Hamamatsu Photonics UK Limited: 2 Howard Court, 10 Tewin Road, Welwyn Garden City, Hertfordshire AL7 1BW, United Kingdom, Telephone: (44) 1707-294888, Fax: (44) 1707-325777

North Europe: Hamamatsu Photonics Norden AB: Smidsvågen 12, SE-171 41 Solna, Sweden, Telephone: (46) 8-509-031-00, Fax: (46) 8-509-031-01

Italy: Hamamatsu Photonics Italia S.R.L.: Strada della Moia, 1/E, 20020 Arese, (Milano), Italy, Telephone: (39) 02-935-81-733, Fax: (39) 02-935-81-741

Cat. No. KCDS1004E03
Mar. 2003 DN