

Applications

- ❑ Bluetooth™ Class 1
- ❑ USB Dongles
- ❑ Laptops
- ❑ Access Points
- ❑ Cordless Piconets

Features

- ❑ +22.5dBm at 45% Power Added Efficiency
- ❑ Low current 80mA typical @ Pout=+20 dBm
- ❑ Temperature stability better than 1dB
- ❑ Power-control and Power-down modes
- ❑ Single 3.3 V Supply Operation
- ❑ Temperature rating: -40C to +85C
- ❑ Very small plastic package - 6 lead LPCC (1.6mm x 3.0mm)

Product Description

A monolithic, high-efficiency, silicon-germanium power amplifier IC, the PA2423L is designed for class 1 Bluetooth™ 2.4 GHz radio applications. It delivers +22.5 dBm output power with 45% power-added efficiency – making it capable of overcoming insertion losses of up to 2.5 dB between amplifier output and antenna input in class 1 Bluetooth™ applications.

The amplifier features:

- ❑ an analog control input for improving PAE at reduced output power levels;
- ❑ a digital control input for controlling power up and power down modes of operation.

An on-chip ramping circuit provides the turn-on/off switching of amplifier output with less than 3dB overshoot, meeting the Bluetooth™ specification 1.1.

The PA2423L operates at 3.3V DC. At typical output power level (+22.5 dBm), its current consumption is 125 mA.

The silicon/silicon-germanium structure of the PA2423L – and its exposed-die-pad package, soldered to the system PCB – provide high thermal conductivity and a subsequently low junction temperature. This device is capable of operating at a duty cycle of 100 percent.

Ordering Information

Type	Package	Shipping Method
PA2423L	6 - LPCC	Tape and reel Tubes -samples
PA2423L-EV	Evaluation kit	

Functional Block Diagram

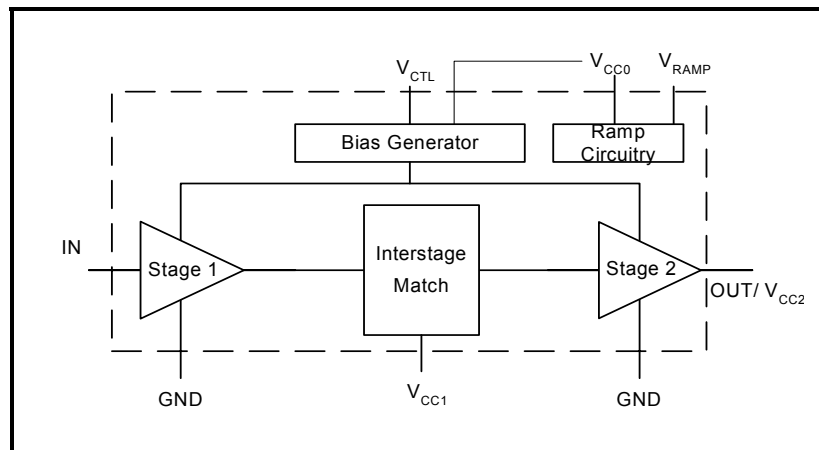

Pin Out Diagram

TOP VIEW

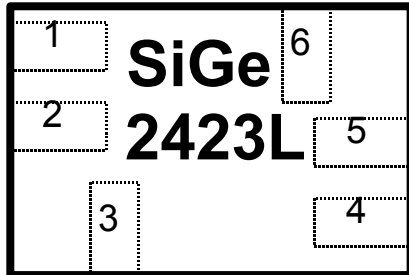

BOTTOM VIEW

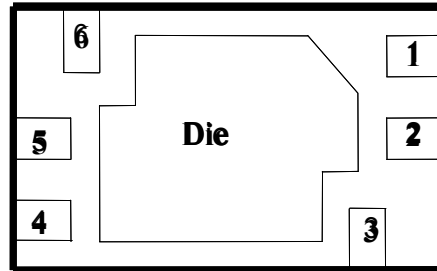

Pin Out Description

Pin No.	Name	Description
1	V _{CTL}	Controls the output level of the power amplifier. An analog control signal between 0V and V _{cc} varies the PA output power between minimum and maximum values
2	V _{RAMP}	Enable/Disable the power amplifier. A digital control signal with V _{cc} logic high (power up) and 0V logic low (power down) is used to turn the device on and off.
3	IN	Power amplifier RF input, external input matching network with DC blocking is required
4	V _{CC0}	Bias supply voltage
5	V _{CC1}	Stage 1 collector supply voltage, external inter-stage matching network is required
6	OUT/V _{CC2}	PA Output and Stage2 collector supply voltage, external output matching network with DC blocking is required
Die Pad	GND	Heatslug Die Pad is ground

Absolute Maximum Ratings

Symbol	Parameter	Min.	Max.	Unit
V _{CC}	Supply Voltage	-0.3	+3.6	V
V _{CTL}	Control Voltage	-0.3	V _{CC}	V
V _{RAMP}	Ramping Voltage	-0.3	V _{CC}	V
I _N	RF Input Power		+8	dBm
T _A	Operating Temperature Range	-40	+85	°C
T _{STG}	Storage Temperature Range	-40	+150	°C
T _j	Maximum Junction Temperature		+150	°C

Operation in excess of any one of above Absolute Maximum Ratings may result in permanent damage. This device is a high performance RF integrated circuit with ESD rating < 600V and is ESD sensitive. Handling and assembly of this device should be at ESD protected workstations.

DC Electrical Characteristics

Conditions: V_{CC0} = V_{CC1} = V_{CC2} = V_{RAMP} = 3.3V, V_{CTL} = 3.3V, P_{IN} = +2dBm, T_A = 25°C, f = 2.45GHz,
 Input and Output externally matched to 50Ω, unless otherwise noted.

Symbol	Note	Parameter	Min.	Typ.	Max.	Unit
V _{CC}		Supply Voltage	3	3.3	3.6	V
I _{CC}	1	Supply Current (I _{CC} = I _{VCC0} + I _{VCC1} + I _{VCC2}), V _{CTL} = 3.3V		125	150	mA
ΔI _{CCtemp}	3	Supply Current variation over temperature from T _A = 25°C (-40°C < T _A < +85°C)		25		%
V _{CTL}		PA Output Power Control Voltage Range	0		V _{CC}	V
I _{CTL}	1	Current sourced by V _{CTL} Pin		200	250	μA
V _{RAMP}	3	Logic High Voltage	2.0			V
	3	Logic Low Voltage			0.8	V
I _{stdby}	1	Leakage Current when V _{ramp} = 0V, V _{ctl} = high		0.5	10	μA

AC Electrical Characteristics

Conditions: $V_{CC0} = V_{CC1} = V_{CC2} = V_{RAMP} = 3.3V$, $V_{CTL} = 3.3V$, $P_{IN} = +2 \text{ dBm}$, $T_A = 25^\circ\text{C}$, $f = 2.45 \text{ GHz}$,
 Input and Output externally matched to 50Ω , unless otherwise noted.

Symbol	Note	Parameter	Min.	Typ.	Max	Unit
f_{L-U}	3	Frequency Range	2400		2500	MHz
P_{out}	1	Output Power @ $P_{IN} = +2 \text{ dBm}$, $V_{CTL} = 3.3V$	20	22.5	23.5	dBm
	1	Output Power @ $P_{IN} = +2 \text{ dBm}$, $V_{CTL} = 0.4V$		-20	0	dBm
ΔP_{temp}	3	Output Power variation over temperature ($-40^\circ\text{C} < T_A < +85^\circ\text{C}$)		1	2	dB
dP_{OUT} / dV_{CTL}	3	Control Voltage Sensitivity			120	dBm/V
PAE		Power Added Efficiency at +22.5 dBm Output Power		45		%
GVAR	3	Gain Variation over band (2400-2500 MHz)		0.7	1.0	dB
2f, 3f, 4f, 5f	3.4	Harmonics		-40	-35	dBc
IS21 IOFF	2	Isolation in "OFF" State, $P_{IN} = +2 \text{ dBm}$, $V_{RAMP} = 0V$	15	20		dB
IS12I	2	Reverse Isolation	32	42		dB
STAB	2	Stability ($P_{IN} = +2 \text{ dBm}$, Load VSWR = 6:1)	All non-harmonically related outputs less than -50 dBc			

- Notes:** (1) Guaranteed by production test at $T_A = 25^\circ\text{C}$.
 (2) Guaranteed by design only
 (3) Guaranteed by design and characterization
 (4) Harmonic levels are greatly affected by topology of external matching networks.

Typical Performance Characteristics

Test Conditions: SiGe PA2423L-EV: $V_{CC0} = V_{CC1} = V_{CC2} = V_{RAMP} = 3.3V$, $V_{CTL} = 3.3V$, $P_{IN} = +2 \text{ dBm}$, $T_A = 25^\circ\text{C}$, $f = 2.45 \text{ GHz}$, Input and Output externally matched to 50Ω , unless otherwise noted.

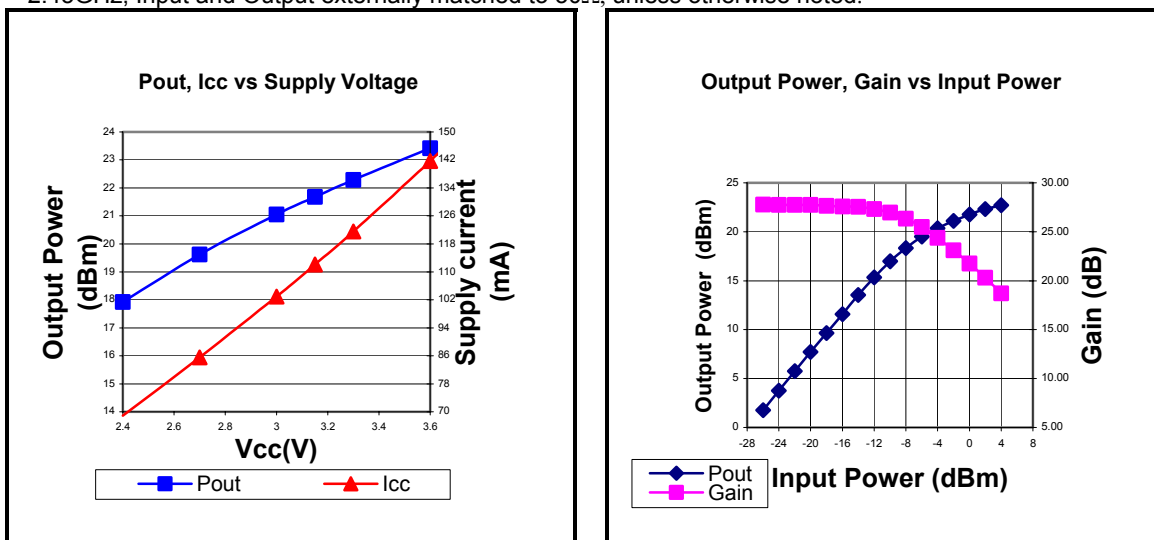

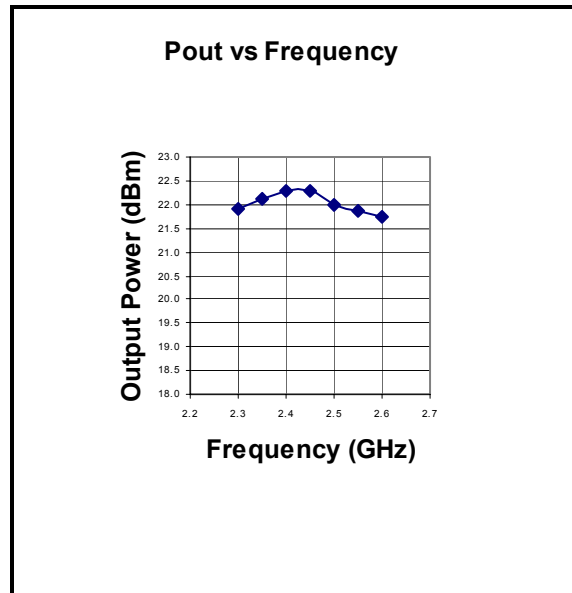
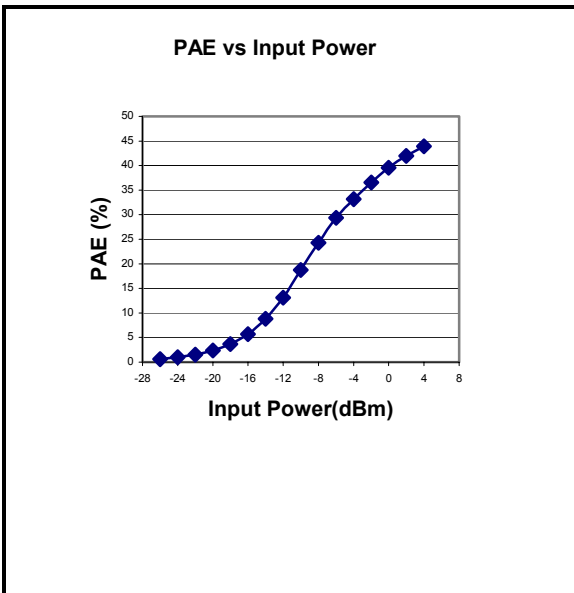
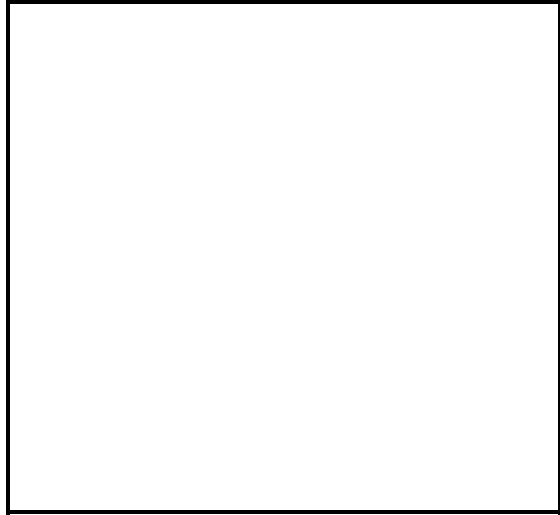
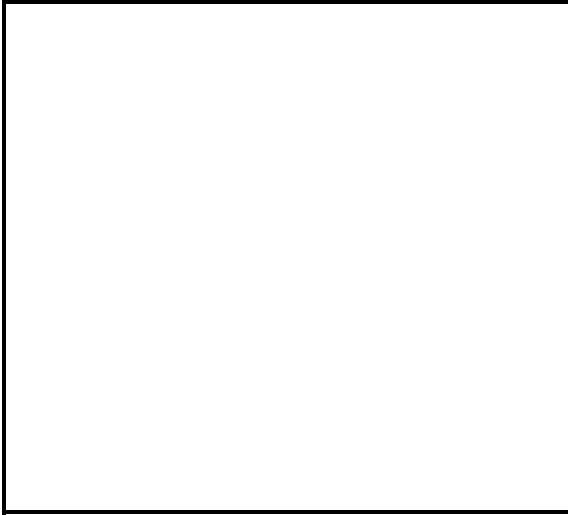

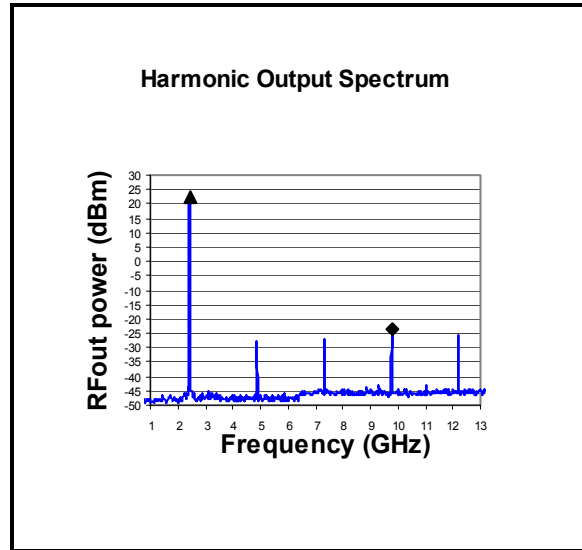
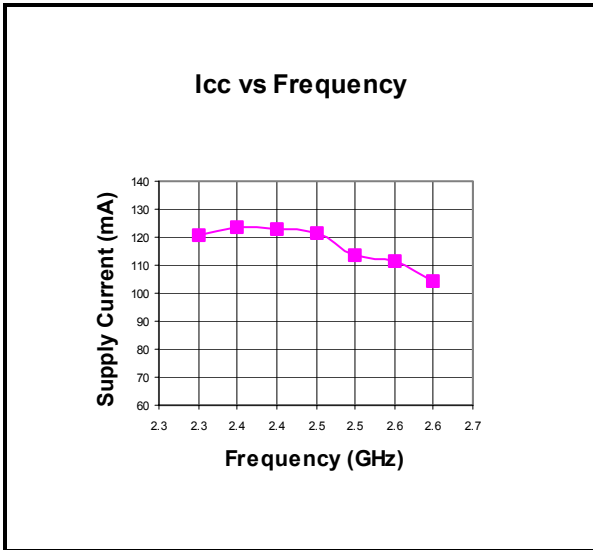
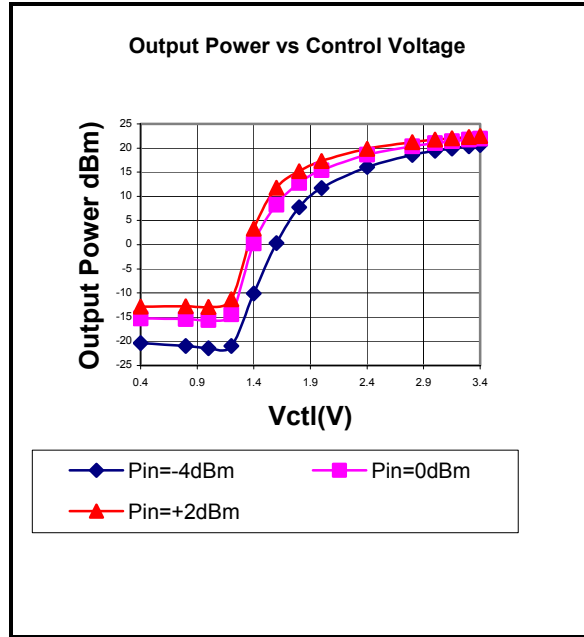
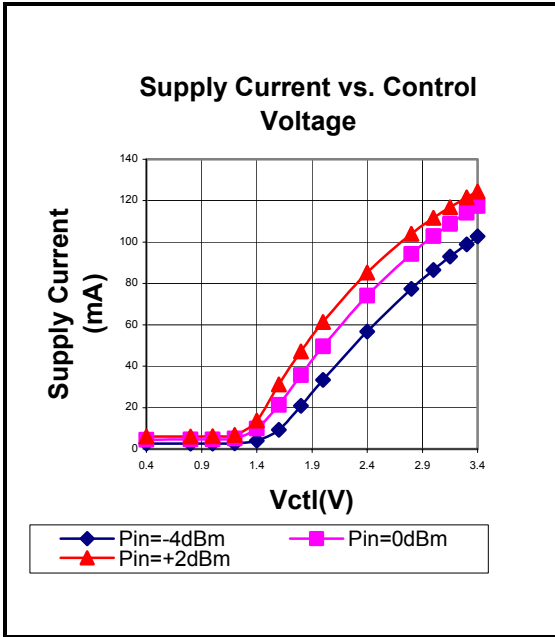

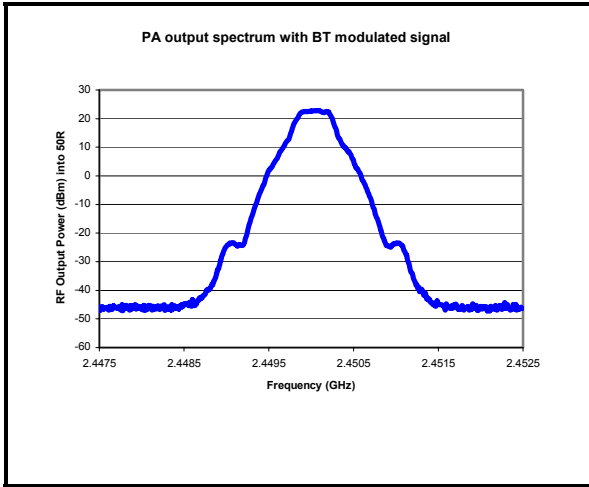

Package Dimensions

The PA2423L is packaged in a 1.6 mm x 3.0 mm 6 lead LPCC package. The underside of the package is an exposed die-pad structure. This allows for direct soldering to the PCB for enhanced thermal conductivity. The package dimensions are shown in the drawing below.

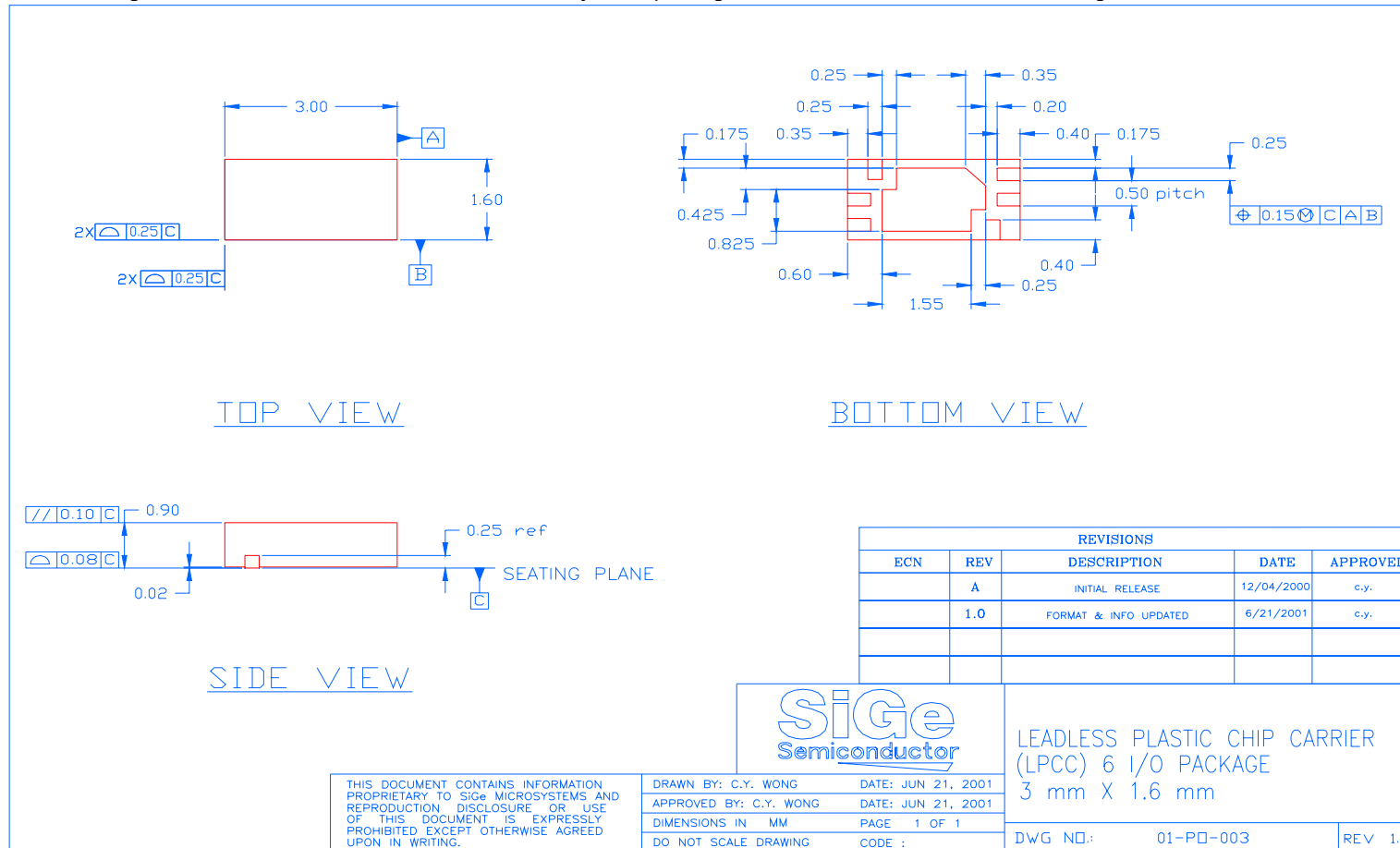

LPCC 6 PCB Footprint Layout

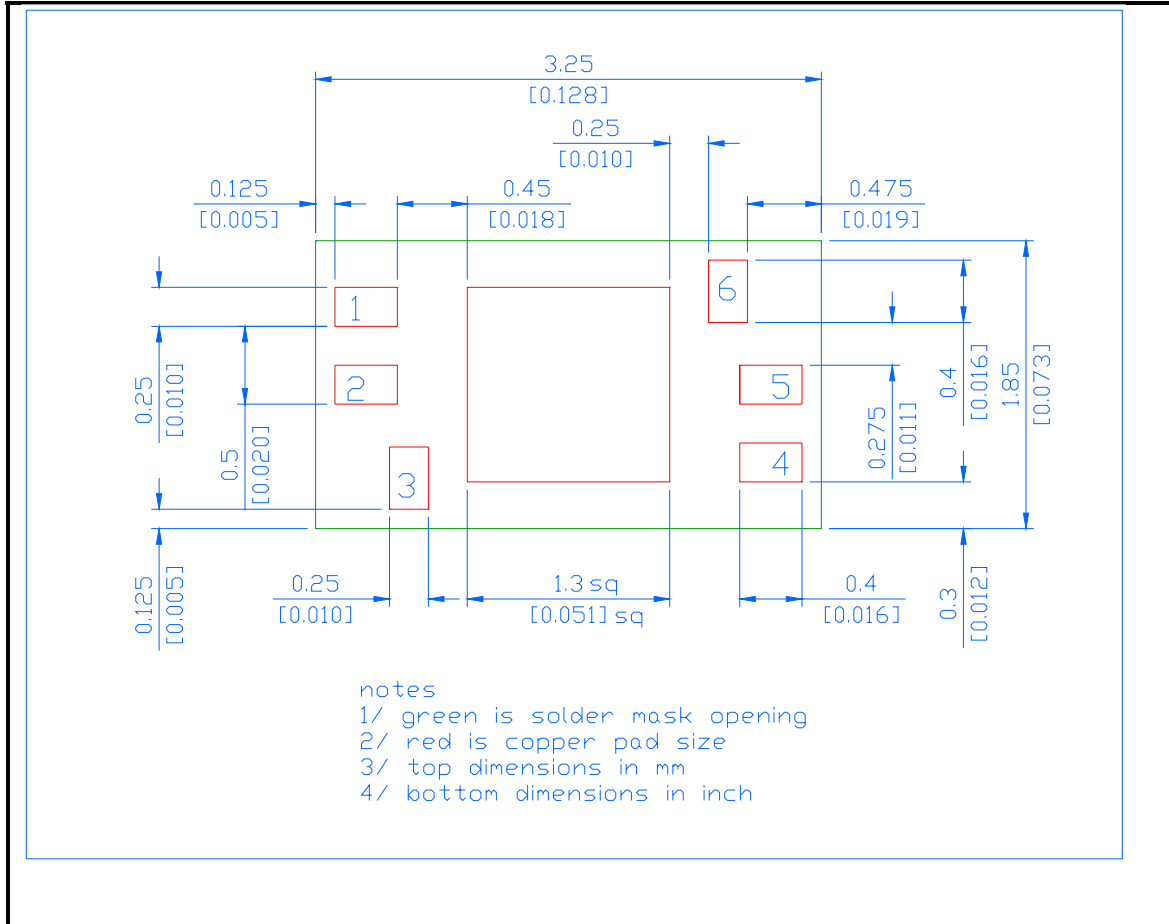

Applications Information

For test and design purposes, SiGe Semiconductor offers an evaluation board for the PA2423L. The order part number for the evaluation board is PA2423L-EV. The evaluation board is intended to simplify the testing with respect to RF performance of this power amplifier.

The application note, 05AN006 provides the supporting information for using the evaluation board. It contains information on the schematic, bill of materials and recommended layout for the power amplifier and the input and output matching networks. To assist in the design process, this layout is available, upon request, in gerber file format.

Using V_{RAMP}

V_{RAMP} is a digital pin used to power-up and power-down the PA2423L in Time Duplex systems such as Bluetooth™ 1.1. During receive mode, V_{RAMP} voltage is pulled down, PA2423L acts as a 25 dB isolation block between the radio and the antenna while consuming a modest 1uA. In transmit mode, V_{RAMP} voltage is pulled to VCC and PA2423L offers 19 dB to 21dB of large signal gain. The rise and fall time are in the order of 1-2usec.

Using V_{CTL}

V_{CTL} is an analog pin that is designed to control the gain of PA2423L. Applying a voltage between 0V and V_{CC} will adjust the gain between -15dB and 21 dB. Used in combination with a variable drive level to PA2423L, the V_{CTL} function can greatly optimize the PAE of the system at all four Bluetooth™ transmitted power levels.

By applying approximately 1.4V to V_{CTL} , for example, a Class1 radio can be modified to a Class2 radio with the PA2423L consuming only 15mA.

By implementing a resistor DAC, the V_{CTL} pin can interface with Bluetooth™ transceivers offering digital and programmable outputs.

<http://www.sige.com>

Headquarters: Canada

Phone: +1 613 820 9244

Fax: +1 613 820 4933

2680 Queensview Drive

Ottawa ON K2B 8J9 Canada

sales@sige.com

U.S.A.

19925 Stevens Creek Blvd.
Suite 135
Cupertino, CA 95014-2358

Phone: +1 408 973 7835

Fax: +1 408 973 7235

United Kingdom

1010 Cambourne Business Park
Cambourne
Cambridge CB3 6DP

Phone: +44 1223 598 444

Fax: +44 1223 598 035

Information furnished is believed to be accurate and reliable and is provided on an "as is" basis. SiGe Semiconductor Inc. assumes no responsibility or liability for the direct or indirect consequences of use of such information nor for any infringement of patents or other rights of third parties, which may result from its use. No license or indemnity is granted by implication or otherwise under any patent or other intellectual property rights of SiGe Semiconductor Inc. or third parties. Specifications mentioned in this publication are subject to change without notice. This publication supersedes and replaces all information previously supplied. SiGe Semiconductor Inc. products are NOT authorized for use in implantation or life support applications or systems without express written approval from SiGe Semiconductor Inc.

The Bluetooth trademarks are owned by Bluetooth SIG Inc., USA.

Copyright 2001 SiGe Semiconductor
All Rights Reserved