

Description

The PAM2320 is a 3A step-down DC-DC converter. At heavy load, the constant-frequency PWM control performs excellent stability and transient response. No external compensation components are required.

The PAM2320 supports a range of input voltages from 2.7V to 5.5V, allowing the use of a single Li+/Li-polymer cell, multiple Alkaline/NiMH cell, and other standard power sources. The output voltage is adjustable from 0.6V to the input voltage. The PAM2320 employs internal power switch and synchronous rectifier to minimize external part count and realize high efficiency. During shutdown, the input is disconnected from the output and the shutdown current is less than 1 μ A. Other key features include over-temperature and short circuit protection, and under-voltage lockout to prevent deep battery discharge.

The PAM2320 delivers 3A maximum output current while consuming only 42 μ A of no-load quiescent current. Ultra-low $R_{DS(ON)}$ integrated MOSFETs and 100% duty cycle operation make the PAM2320 an ideal choice for high output voltage, high current applications which require a low dropout threshold.

The PAM2320 is available in PSOP-8 package.

Features

- Output Current: Up to 3A
- Output Voltage: 0.6V to V_{IN}
- Input Voltage: 2.7V to 5.5V
- Efficiency Up to 95%
- 42 μ A (Typ) No Load Quiescent Current
- Shutdown Current: <1 μ A
- 100% Duty Cycle Operation
- 1.5MHz Switching Frequency
- Internal Soft Start
- No External Compensation Required
- Current Limit Protection
- Thermal Shutdown
- PSOP-8 Package
- **Totally Lead-Free & Fully RoHS Compliant (Notes 1 & 2)**
- **Halogen and Antimony Free. "Green" Device (Note 3)**
- **For automotive applications requiring specific change control (i.e. parts qualified to AEC-Q100/101/200, PPAP capable, and manufactured in IATF 16949 certified facilities), please [contact us](#) or your local Diodes representative.**
<https://www.diodes.com/quality/product-definitions/>

Pin Assignments

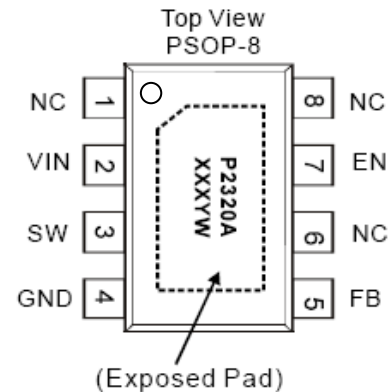

Applications

- 5V or 3.3V Point of Load Conversion
- Telecom/Networking Equipment
- Set Top Boxes
- Storage Equipment
- Video Cards
- DDR Power Supply

Notes: 1. No purposely added lead. Fully EU Directive 2002/95/EC (RoHS), 2011/65/EU (RoHS 2) & 2015/863/EU (RoHS 3) compliant.
2. See <https://www.diodes.com/quality/lead-free/> for more information about Diodes Incorporated's definitions of Halogen- and Antimony-free, "Green" and Lead-free.
3. Halogen- and Antimony-free "Green" products are defined as those which contain <900ppm bromine, <900ppm chlorine (<1500ppm total Br + Cl) and <1000ppm antimony compounds.

Typical Applications Circuit

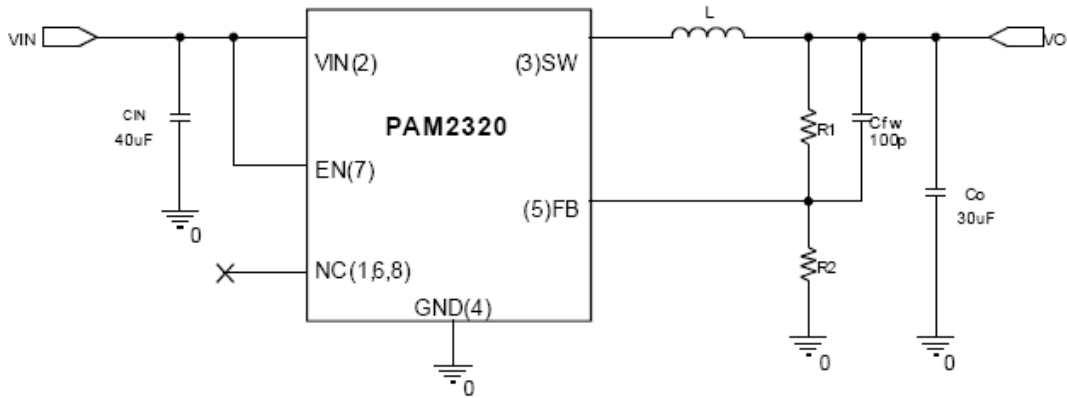

$$V_O = 0.6 \times \left(1 + \frac{R_1}{R_2} \right)$$

Pin Descriptions

Pin Number	PSOP-8 Pin Name	Function
1	NC	Not Connected.
2	VIN	Bias supply. Chip main power supply pin.
3	SW	The drains of the internal main and synchronous power MOSFET.
4	GND	Ground
5	FB	Feedback voltage to internal error amplifier, the threshold voltage is 0.6V.
6	NC	Not Connected.
7	EN	Enable control input. Force this pin voltage above 1.5V, enables the chip, and below 0.3V shuts down the device.
8	NC	Not Connected.

Functional Block Diagram

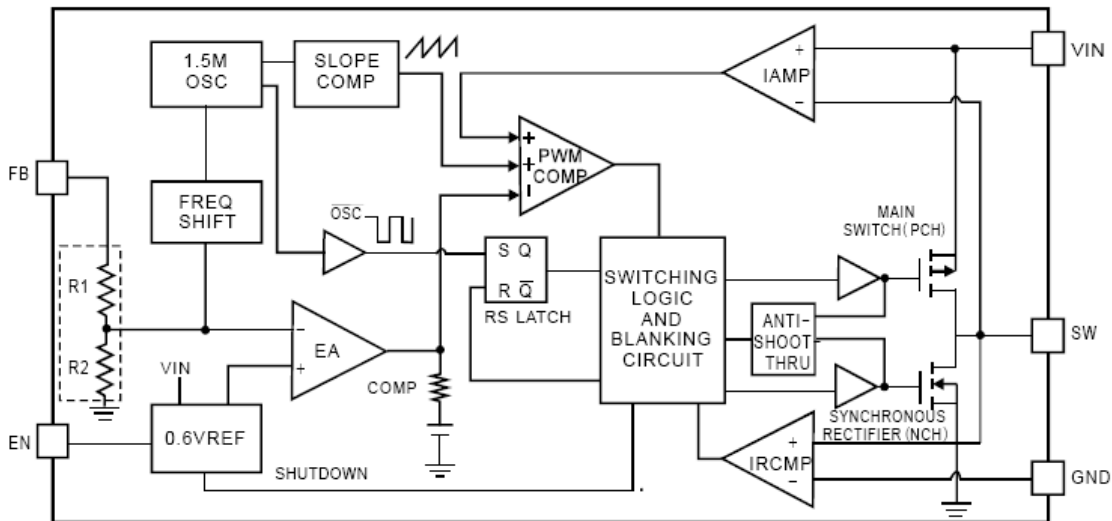

Absolute Maximum Ratings (@T_A = +25°C, unless otherwise specified.)

These are stress ratings only and functional operation is not implied. Exposure to absolute maximum ratings for prolonged time periods may affect device reliability. All voltages are with respect to ground.

Parameter	Rating	Unit
Input Voltage V _{IN}	6	V
SW Pin Voltage	-0.3 to (V _{IN} +0.3)	V
FB Pin Voltage	-0.3 to (V _{IN} +0.3)	V
EN Pin Voltage	-0.3 to +6.0	V
Maximum Junction Temperature	+150	°C
Storage Temperature Range	-65 to +150	°C
Soldering Temperature	+300, 5sec	°C

Recommended Operating Conditions (@T_A = +25°C, unless otherwise specified.)

Parameter	Rating	Unit
Supply Voltage	2.7 to 5.5	V
Junction Temperature Range	-40 to +125	°C
Ambient Temperature Range	-40 to +85	

Thermal Information

Parameter	Symbol	Package	Max	Unit
Thermal Resistance (Junction to Ambient)	θ _{JA}	PSOP-8	90	°C/W
Thermal Resistance (Junction to Case)	θ _{JC}	PSOP-8	14	
Internal Power Dissipation (@T _A = +25°C)	P _D	PSOP-8	1100	mW

Electrical Characteristics (@ $T_A = +25^\circ\text{C}$, $V_{IN} = 3.6\text{V}$, $V_O = 1.8\text{V}$, $C_{IN} = 22\mu\text{F}$, $C_O = 22\mu\text{F}$, $L = 2.2\mu\text{H}$, unless otherwise specified.)

Parameter	Symbol	Test Conditions	Min	Typ	Max	Unit
Input Voltage Range	V_{IN}	—	2.7	—	5.5	V
Output Voltage Range	V_O	—	0.6	—	V_{IN}	V
UVLO Threshold	V_{UVLO}	V_{IN} Rising	—	2.4	2.5	V
		Hysteresis	—	240	—	mV
		V_{IN} Falling	1.8	—	—	V
Regulated Output Voltage Accuracy	V_O	$I_O = 0\text{A to }3\text{A}$	-3	—	+2	%
Regulated Feedback Voltage	V_{FB}	—	0.591	0.600	0.609	V
FB Leakage Current	I_{FB}	$V_O = 1\text{V}$	—	—	0.2	μA
Output Voltage Line Regulation	LNR	$V_{IN} = 2.5\text{V to }5\text{V}$	—	0.2	—	%/V
Output Voltage Load Regulation	LDR	$I_O = 0\text{A to }3\text{A}$	—	0.5	—	%/A
Quiescent Current	I_Q	No Load	—	42	90	μA
Shutdown Current	I_{SD}	$V_{EN} = 0\text{V}$	—	—	1	μA
Current Limit	I_{LIM}	—	—	4	—	A
Oscillator Frequency	f_{OSC}	—	1.2	1.5	1.8	MHz
Drain-Source On-State Resistance	$R_{DS(ON)}$	High Side	—	0.85	—	$\text{m}\Omega$
		Low Side	—	60	—	$\text{m}\Omega$
High Efficiency	η	—	—	95	—	%
Analog Soft-Start Time	t_s	From enable to output regulation	—	0.5	3	ms
EN Threshold High	V_{EH}	—	1.5	—	—	V
EN Threshold Low	V_{EL}	—	—	—	0.3	V
EN Leakage Current	I_{EN}	$V_{IN} = V_{EN} = 0\text{V}$	-1.0	—	+1.0	μA
Over Temperature Protection	OTP	—	—	+150	—	$^\circ\text{C}$
OTP Hysteresis	OTH	—	—	+30	—	$^\circ\text{C}$

Typical Performance Characteristics (@ $T_A = +25^\circ\text{C}$, $C_{IN} = 33\mu\text{F}$, $C_O = 22\mu\text{F}$, unless otherwise specified.)

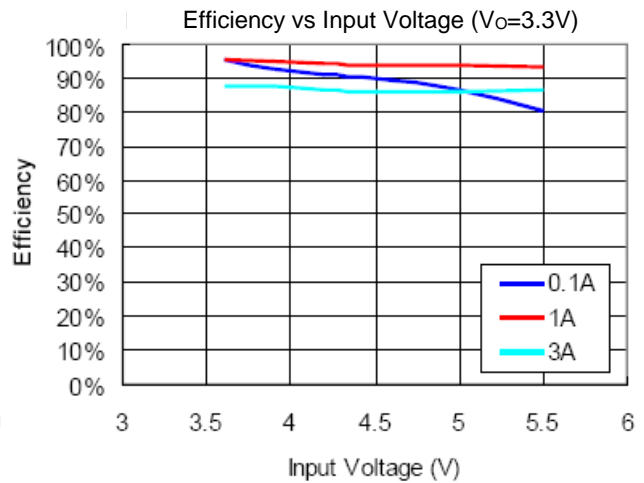
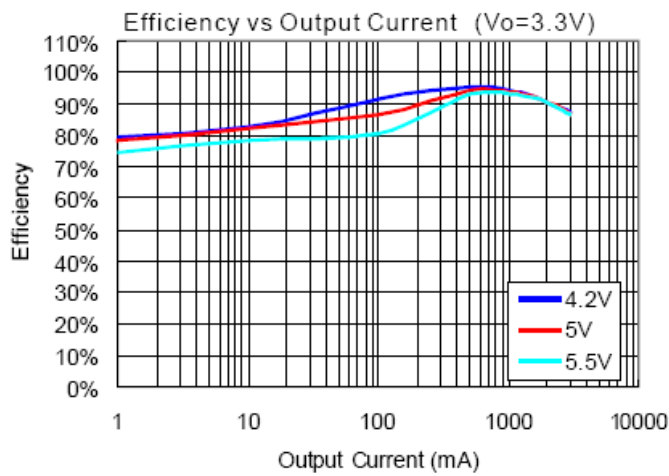
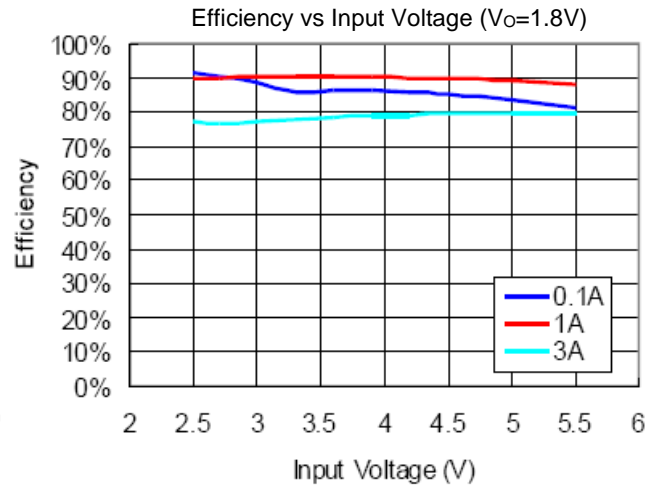
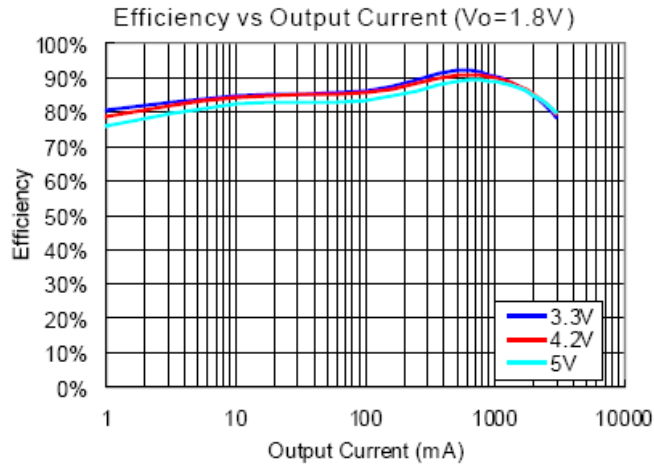
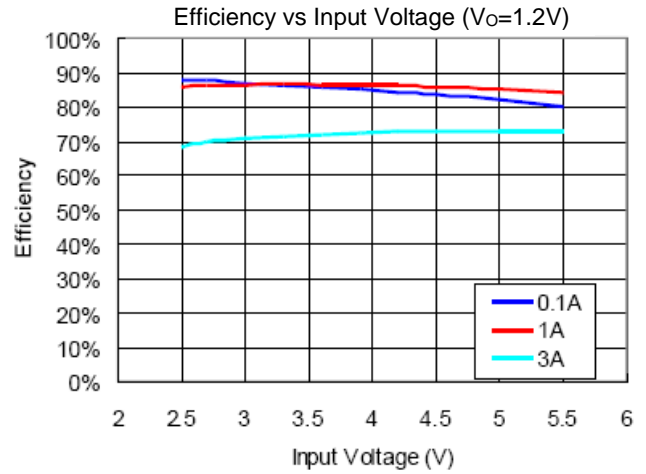
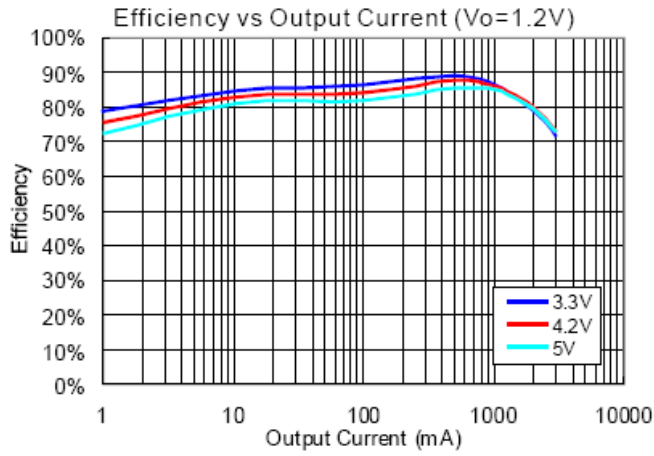

Typical Performance Characteristics (continued) (@ $T_A = +25^\circ\text{C}$, $C_{IN} = 33\mu\text{F}$, $C_O = 22\mu\text{F}$, unless otherwise specified.)

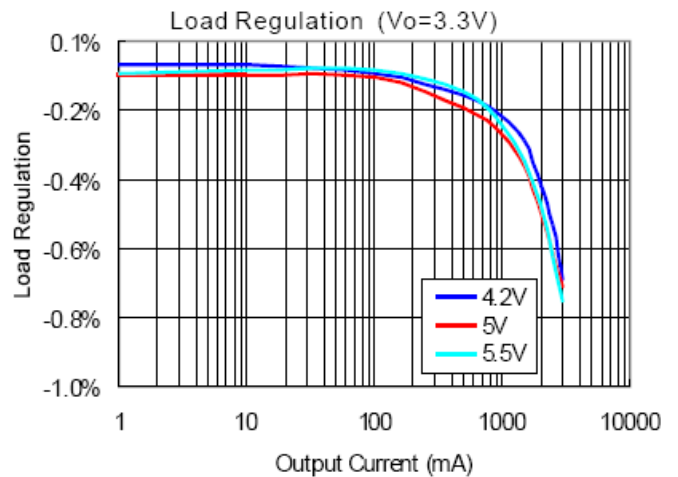
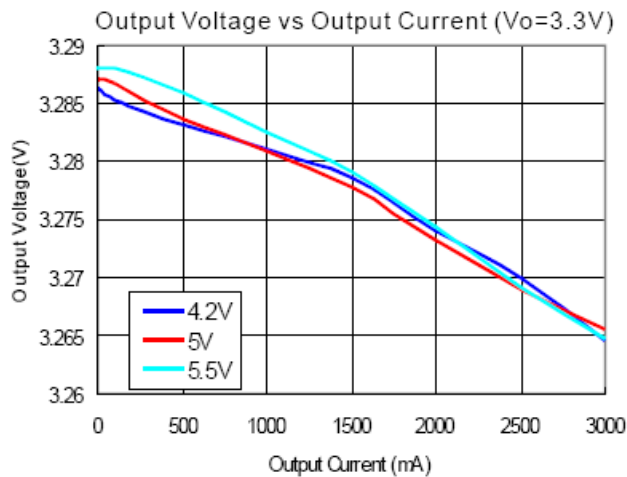
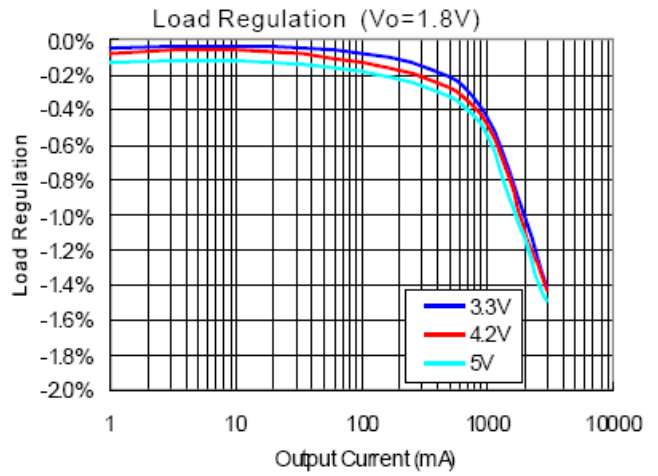
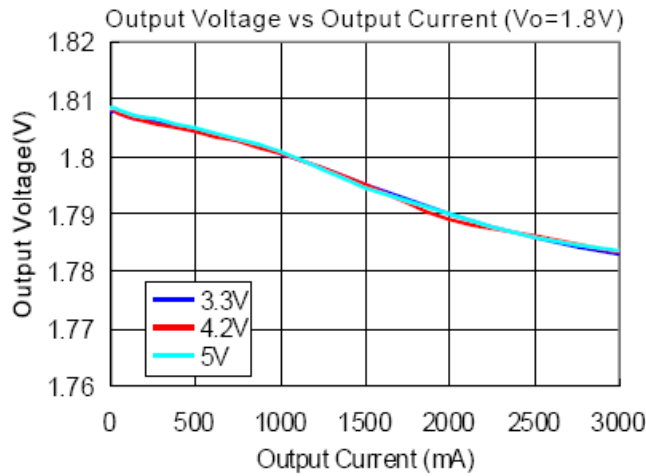
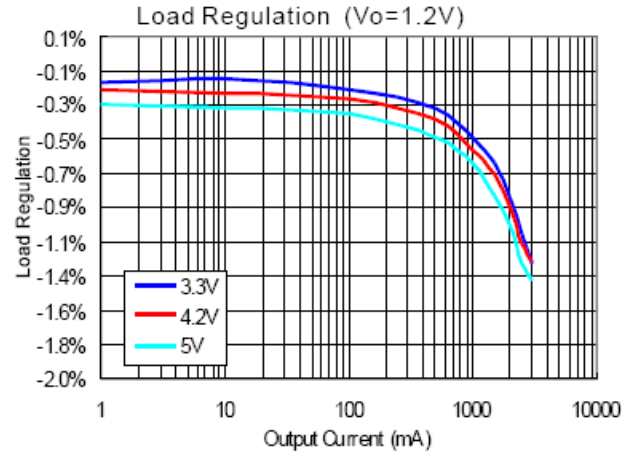
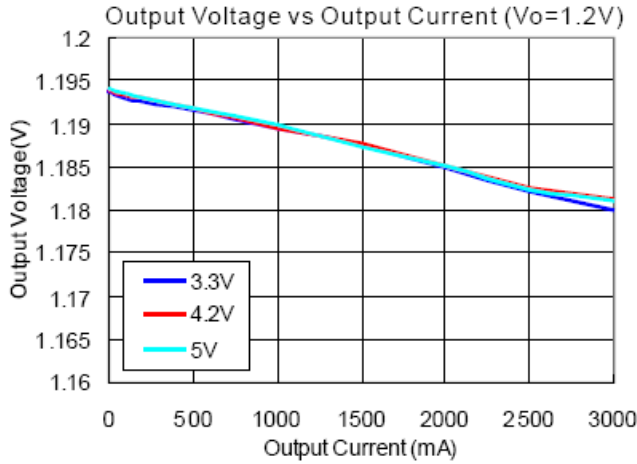

Typical Performance Characteristics (continued) (@T_A = +25°C, C_{IN} = 33μF, C_O = 22μF, unless otherwise specified.)

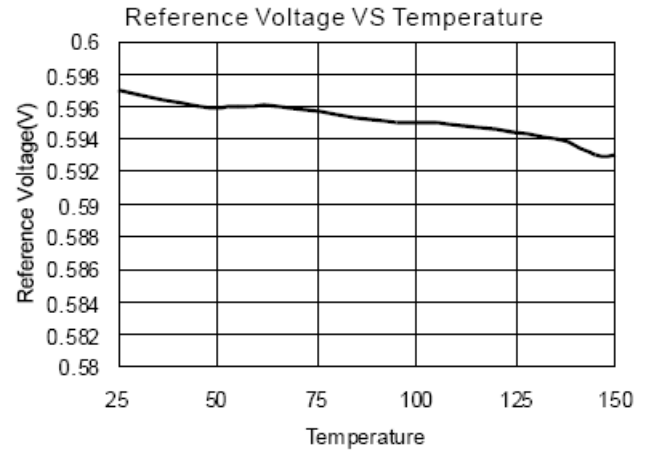
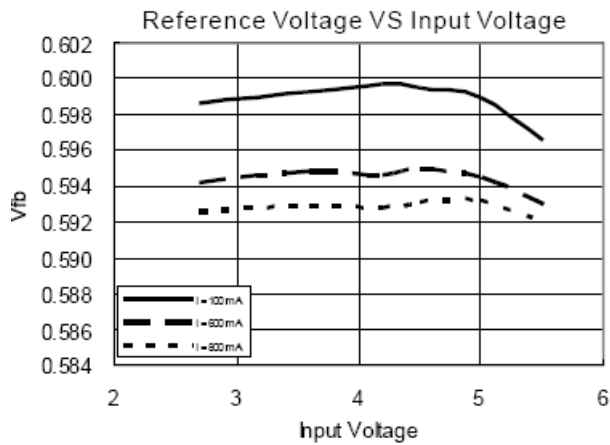
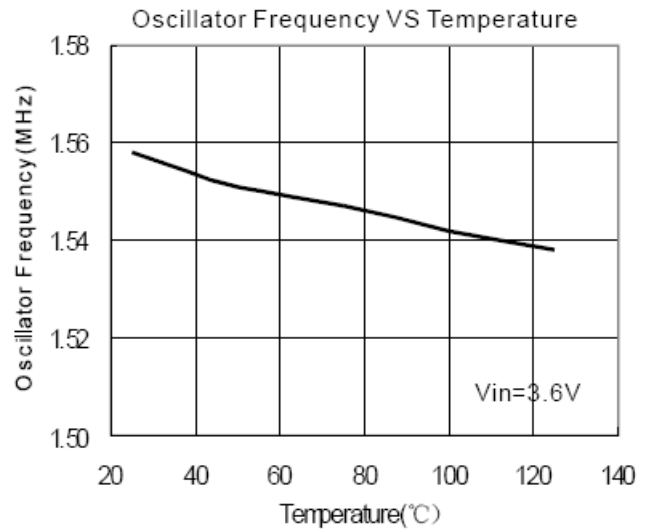
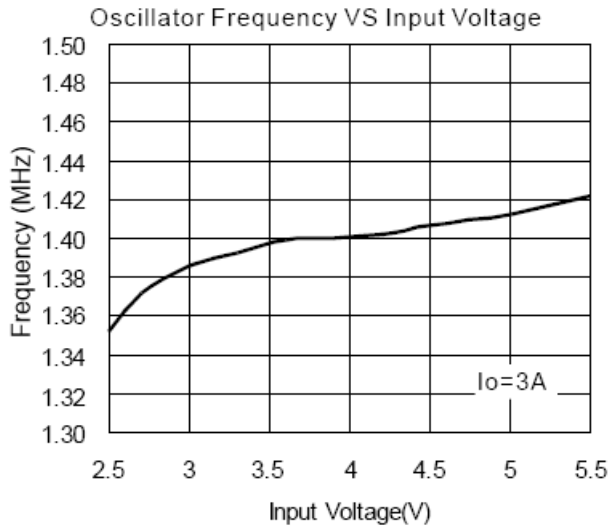
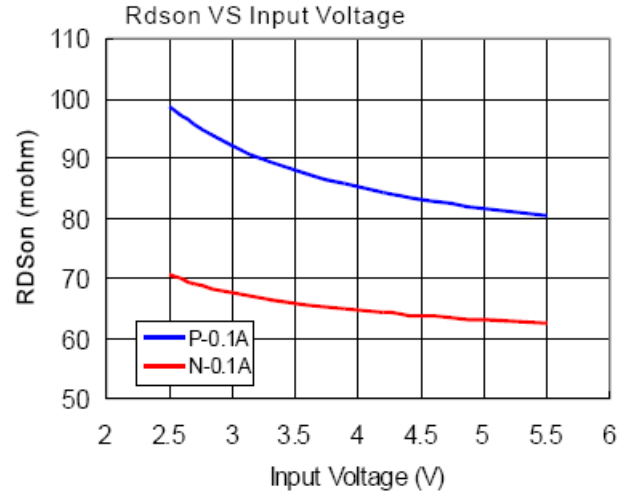
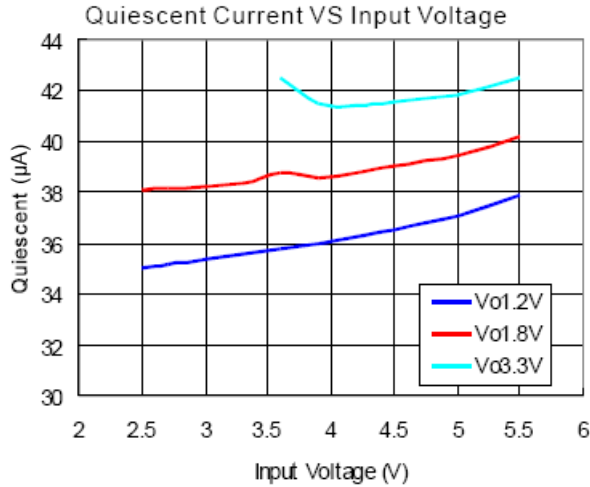

Application Information

The basic PAM2320 application circuit is shown in Page 2. External component selection is determined by the load requirement, selecting L first and then C_{IN} and C_{OUT}.

Inductor Selection

For most applications, the value of the inductor will fall in the range of 1μH to 3.3μH. Its value is chosen based on the desired ripple current and efficiency. Large value inductors lower ripple current and small value inductors result in higher ripple currents. Higher V_{IN} or V_{OUT} also increases the ripple current as shown in equation 3A reasonable starting point for setting ripple current is ΔI_L = 1.2A (40% of 3A).

$$\Delta I_L = \frac{1}{(f)(L)} V_{OUT} \left(1 - \frac{V_{OUT}}{V_{IN}} \right) \quad \text{Equation (1)}$$

The DC current rating of the inductor should be at least equal to the maximum load current plus half the ripple current to prevent core saturation. Thus, a 4.2A rated inductor should be enough for most applications (3A + 1.2A). For better efficiency, choose a low DC-resistance inductor.

V _O	1.2V	1.5V	1.8V	2.5V	3.3V
L	1μH	1.5μH	2.2μH	2.2μH	3.3μH

C_{IN} and C_{OUT} Selection

In continuous mode, the source current of the top MOSFET is a square wave of duty cycle V_{OUT}/V_{IN}. To prevent large voltage transients, a low ESR input capacitor sized for the maximum RMS current must be used. The maximum RMS capacitor current is given by:

$$C_{IN} \text{ required } I_{RMS} \cong I_{OMAX} \frac{[V_{OUT}(V_{IN} - V_{OUT})]^{1/2}}{V_{IN}}$$

This formula has a maximum at V_{IN} = 2V_{OUT}, where I_{RMS} = I_{OUT} / 2. This simple worst-case condition is commonly used for design because even significant deviations do not offer much relief. Note that the capacitor manufacturer's ripple current ratings are often based on 2000 hours of life. This makes it advisable to further derate the capacitor, or choose a capacitor rated at a higher temperature than required. Consult the manufacturer if there is any question.

The selection of C_{OUT} is driven by the required effective series resistance (ESR).

Typically, once the ESR requirement for C_{OUT} has been met, the RMS current rating generally far exceeds the I_{RIPPLE} (P-P) requirement. The output ripple ΔV_{OUT} is determined by:

$$\Delta V_{OUT} \approx \Delta I_L (ESR + 1/8f C_{OUT})$$

Where f = operating frequency, C_{OUT} = output capacitance and ΔI_L = ripple current in the inductor. For a fixed output voltage, the output ripple is highest at maximum input voltage since ΔI_L increases with input voltage.

Using Ceramic Input and Output Capacitors

Higher values, lower cost ceramic capacitors are now becoming available in smaller case sizes. Their high ripple current, high voltage rating and low ESR make them ideal for switching regulator applications. Using ceramic capacitors can achieve very low output ripple and small circuit size.

When choosing the input and output ceramic capacitors, choose the X5R or X7R dielectric formulations. These dielectrics have the best temperature and voltage characteristics of all the ceramics for a given value and size.

Thermal Consideration

Thermal protection limits power dissipation in the PAM2320. When the junction temperature exceeds +150°C, the OTP (Over Temperature Protection) starts the thermal shutdown and turns the pass transistor off. The pass transistor resumes operation after the junction temperature drops below +120°C.

For continuous operation, the junction temperature should be maintained below +125°C. The power dissipation is defined as:

$$P_D = I_O^2 \frac{V_O R_{DS(ON)H} + (V_{IN} - V_O) R_{DS(ON)L}}{V_{IN}} + (t_{SW} F_S I_O + I_Q) V_{IN}$$

I_Q is the step-down converter quiescent current. The term t_{sw} is used to estimate the full load step-down converter switching losses.

Application Information (continued)

For the condition where the step-down converter is in dropout at 100% duty cycle, the total device dissipation reduces to:

$$P_D = I_O^2 R_{DS(ON)H} + I_Q V_{IN}$$

Since $R_{DS(ON)}$, quiescent current, and switching losses all vary with input voltage, the total losses should be investigated over the complete input voltage range. The maximum power dissipation depends on the thermal resistance of IC package, PCB layout, the rate of surrounding airflow and temperature difference between junction and ambient. The maximum power dissipation can be calculated by the following formula:

$$P_D = \frac{T_{J(MAX)} - T_A}{\theta_{JA}}$$

Where $T_{J(max)}$ is the maximum allowable junction temperature +125°C. T_A is the ambient temperature and θ_{JA} is the thermal resistance from the junction to the ambient. Based on the standard JEDEC for a two layers thermal test board, the thermal resistance θ_{JA} of PSOP-8 90°C/W respectively. The maximum power dissipation at $T_A = +25^\circ\text{C}$ can be calculated by following formula:

$$P_D = (125^\circ\text{C} - 25^\circ\text{C}) / 90^\circ\text{C/W} = 1.11\text{W (PSOP-8)}$$

Setting the Output Voltage

The internal reference is 0.6V (Typical). The output voltage is calculated as below:

The output voltage is given by Table 1.

$$V_O = 0.6 \times \left(1 + \frac{R1}{R2} \right)$$

Table 1: Resistor selection for output voltage setting.

V_O	R1	R2
1.2V	150k	150k
1.5V	225k	150k
1.8V	300k	150k
2.5V	475k	150k
3.3V	680k	150k

100% Duty Cycle Operation

As the input voltage approaches the output voltage, the converter turns the P-Channel transistor continuously on. In this mode the output voltage is equal to the input voltage minus the voltage drop across the P-Channel transistor:

$$V_{OUT} = V_{IN} - I_{LOAD} (R_{DS(ON)} + R_L)$$

Where $R_{DS(ON)}$ = P-Channel switch ON resistance, I_{LOAD} = Output Current, R_L = Inductor DC Resistance

UVLO and Soft-Start

The reference and the circuit remain reset until the V_{IN} crosses its UVLO threshold.

The PAM2320 has an internal soft-start circuit that limits the in-rush current during start-up. This prevents possible voltage drops of the input voltage and eliminates the output voltage overshoot. The soft-start make the output voltage rise up smoothly.

Short Circuit Protection

The switch peak current is limited cycle-by-cycle to a typical value of 4A. In the event of an output voltage short circuit, the device operates with a frequency of 500kHz and minimum duty cycle, therefore the average input current is more smaller than current limit.

Thermal Shutdown

When the die temperature exceeds +150°C, a reset occurs and the reset remains until the temperature decrease to +120°C, at which time the circuit can be restarted.

Ordering Information

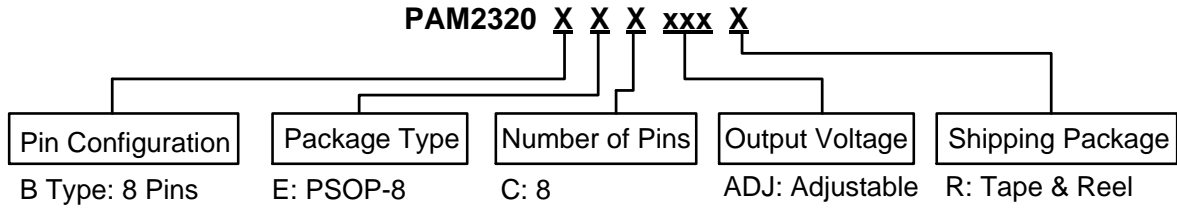

Part Number	Output Voltage	Package Type	Standard Package
PAM2320BECADJR	ADJ	PSOP-8	2500 Units/Tape & Reel

Marking Information

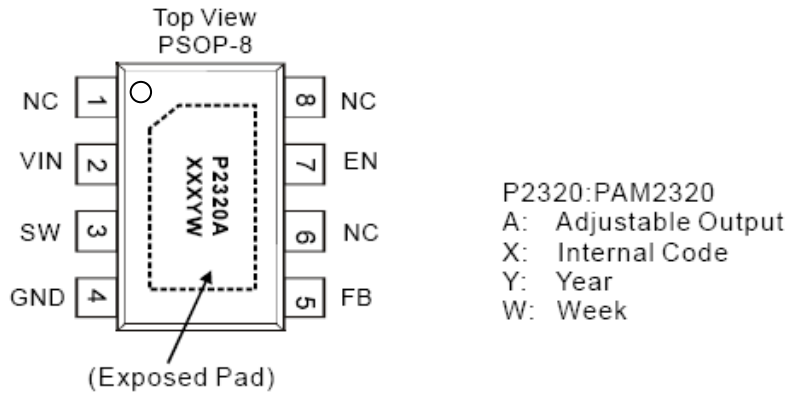

Package Outline Dimensions (All dimensions in mm.)

Please see <http://www.diodes.com/package-outlines.html> for the latest version.

PSOP-8

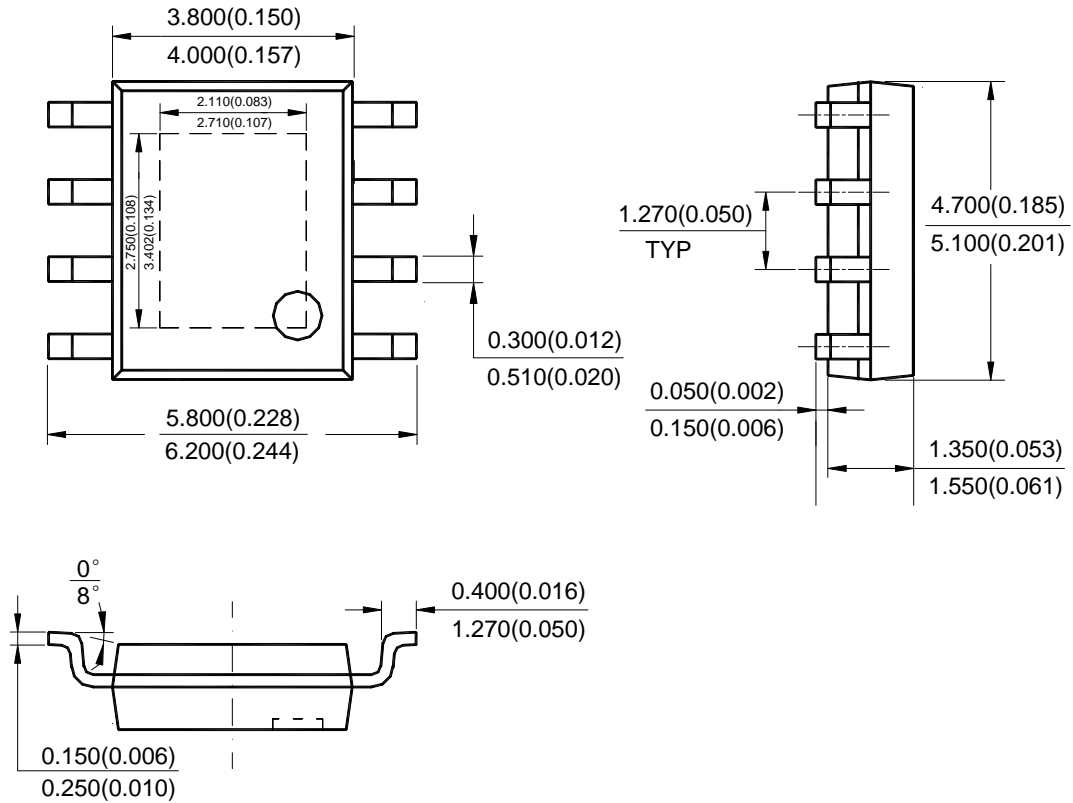

Note: Eject hole, oriented hole and mold mark is optional.

Suggested Pad Layout (All dimensions in mm.)

Please see <http://www.diodes.com/package-outlines.html> for the latest version.

PSOP-8

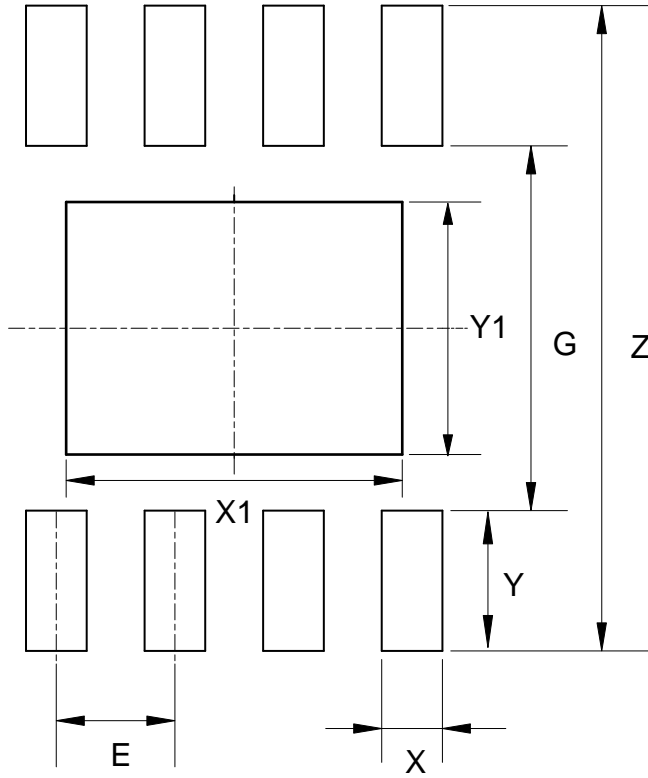

Dimensions	Z (mm)/(inch)	G (mm)/(inch)	X (mm)/(inch)	Y (mm)/(inch)	X1 (mm)/(inch)	Y1 (mm)/(inch)	E (mm)/(inch)
Value	6.900/0.272	3.900/0.154	0.650/0.026	1.500/0.059	3.600/0.142	2.700/0.106	1.270/0.050

Mechanical Data

- Moisture Sensitivity: Level 1 per J-STD-020
- Terminals: Finish – Matte Tin Plated Leads, Solderable per MIL-STD-202, Method 208 ③
- Weight: 0.081 grams (Approximate)

IMPORTANT NOTICE

1. DIODES INCORPORATED AND ITS SUBSIDIARIES (“DIODES”) MAKE NO WARRANTY OF ANY KIND, EXPRESS OR IMPLIED, WITH REGARDS TO ANY INFORMATION CONTAINED IN THIS DOCUMENT, INCLUDING, BUT NOT LIMITED TO, THE IMPLIED WARRANTIES OF MERCHANTABILITY, FITNESS FOR A PARTICULAR PURPOSE OR NON-INFRINGEMENT OF THIRD PARTY INTELLECTUAL PROPERTY RIGHTS (AND THEIR EQUIVALENTS UNDER THE LAWS OF ANY JURISDICTION).
2. The Information contained herein is for informational purpose only and is provided only to illustrate the operation of Diodes products described herein and application examples. Diodes does not assume any liability arising out of the application or use of this document or any product described herein. This document is intended for skilled and technically trained engineering customers and users who design with Diodes products. Diodes products may be used to facilitate safety-related applications; however, in all instances customers and users are responsible for (a) selecting the appropriate Diodes products for their applications, (b) evaluating the suitability of the Diodes products for their intended applications, (c) ensuring their applications, which incorporate Diodes products, comply the applicable legal and regulatory requirements as well as safety and functional-safety related standards, and (d) ensuring they design with appropriate safeguards (including testing, validation, quality control techniques, redundancy, malfunction prevention, and appropriate treatment for aging degradation) to minimize the risks associated with their applications.
3. Diodes assumes no liability for any application-related information, support, assistance or feedback that may be provided by Diodes from time to time. Any customer or user of this document or products described herein will assume all risks and liabilities associated with such use, and will hold Diodes and all companies whose products are represented herein or on Diodes’ websites, harmless against all damages and liabilities.
4. Products described herein may be covered by one or more United States, international or foreign patents and pending patent applications. Product names and markings noted herein may also be covered by one or more United States, international or foreign trademarks and trademark applications. Diodes does not convey any license under any of its intellectual property rights or the rights of any third parties (including third parties whose products and services may be described in this document or on Diodes’ website) under this document.
5. Diodes products are provided subject to Diodes’ Standard Terms and Conditions of Sale (<https://www.diodes.com/about/company/terms-and-conditions/terms-and-conditions-of-sales/>) or other applicable terms. This document does not alter or expand the applicable warranties provided by Diodes. Diodes does not warrant or accept any liability whatsoever in respect of any products purchased through unauthorized sales channel.
6. Diodes products and technology may not be used for or incorporated into any products or systems whose manufacture, use or sale is prohibited under any applicable laws and regulations. Should customers or users use Diodes products in contravention of any applicable laws or regulations, or for any unintended or unauthorized application, customers and users will (a) be solely responsible for any damages, losses or penalties arising in connection therewith or as a result thereof, and (b) indemnify and hold Diodes and its representatives and agents harmless against any and all claims, damages, expenses, and attorney fees arising out of, directly or indirectly, any claim relating to any noncompliance with the applicable laws and regulations, as well as any unintended or unauthorized application.
7. While efforts have been made to ensure the information contained in this document is accurate, complete and current, it may contain technical inaccuracies, omissions and typographical errors. Diodes does not warrant that information contained in this document is error-free and Diodes is under no obligation to update or otherwise correct this information. Notwithstanding the foregoing, Diodes reserves the right to make modifications, enhancements, improvements, corrections or other changes without further notice to this document and any product described herein. This document is written in English but may be translated into multiple languages for reference. Only the English version of this document is the final and determinative format released by Diodes.
8. Any unauthorized copying, modification, distribution, transmission, display or other use of this document (or any portion hereof) is prohibited. Diodes assumes no responsibility for any losses incurred by the customers or users or any third parties arising from any such unauthorized use.

Copyright © 2021 Diodes Incorporated

www.diodes.com