

PAM2322AGEAR

Dual High-Efficiency PWM Step-Down DC-DC Converter

Description

The PAM2322AGEAR is a dual step-down current-mode, DC-DC converter. At heavy load, the constant-frequency PWM control performs with excellent stability and transient response. To ensure the longest battery life in portable applications, the PAM2322AGEAR provides a power-saving Pulse-Skipping Modulation (PSM) mode to reduce quiescent current under light load operation

The PAM2322AGEAR supports a range of input voltages from 2.7V to 5.5V, allowing the use of a single Li+/Li-polymer cell, multiple Alkaline/NiMH cell, USB, and other standard power sources. Output 1 is a 1.8V fixed output. Output 2 is adjustable from 0.9V to VIN. Both outputs employ an internal power switch and synchronous rectifier to minimize external part count and realize high efficiency.

Output 1 delivers up to 1000mA output current while output 2 delivers up to 2000mA. Each regulator has an independent enable pin.

Each output of the PAM2322AGEAR can be disabled when a logic low is applied to the channel enable pin. During shutdown, the input is disconnected from the output and the shutdown current is less than 0.1µA

Other key features include under-voltage lockout, soft-start, hiccup mode short circuit protection and thermal shutdown.

Features

- Supply Voltage: 2.7V to 5.5V
- Output Current:
 - OUT1: 1000mA/Buck, 1.8V Fixed Output
 - OUT2: 2000mA/Buck
- Switching Frequency: 1.2MHz
- Internal Synchronous Rectifier
- Fast Transient Response
- Fast Turn On and Turn Off
- Internal Soft Start
- Internal Compensation
- 100% Duty Cycle Operation
- Power Good Indicator for OUT1
- Under-Voltage Lockout
- Hiccup Mode Short Circuit Protection
- Thermal Shutdown
- Small W-FLGA2520-17 Package
- **Totally Lead-Free & Fully RoHS Compliant (Notes 1 & 2)**
- **Halogen and Antimony Free. "Green" Device (Note 3)**

Notes: 1. No purposely added lead. Fully EU Directive 2002/95/EC (RoHS) & 2011/65/EU (RoHS 2) compliant.
 2. See <http://www.diodes.com> for more information about Diodes Incorporated's definitions of Halogen- and Antimony-free, "Green" and Lead-free.
 3. Halogen- and Antimony-free "Green" products are defined as those which contain <900ppm bromine, <900ppm chlorine (<1500ppm total Br + Cl) and <1000ppm antimony compounds.

Pin Assignments

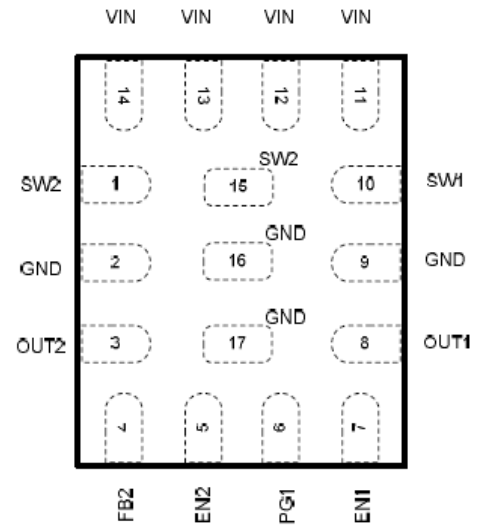

W-FLGA2520-17

Applications

- Portable Electronics
- Personal Information Appliances
- Wireless and DSL Modems

Typical Applications Circuit

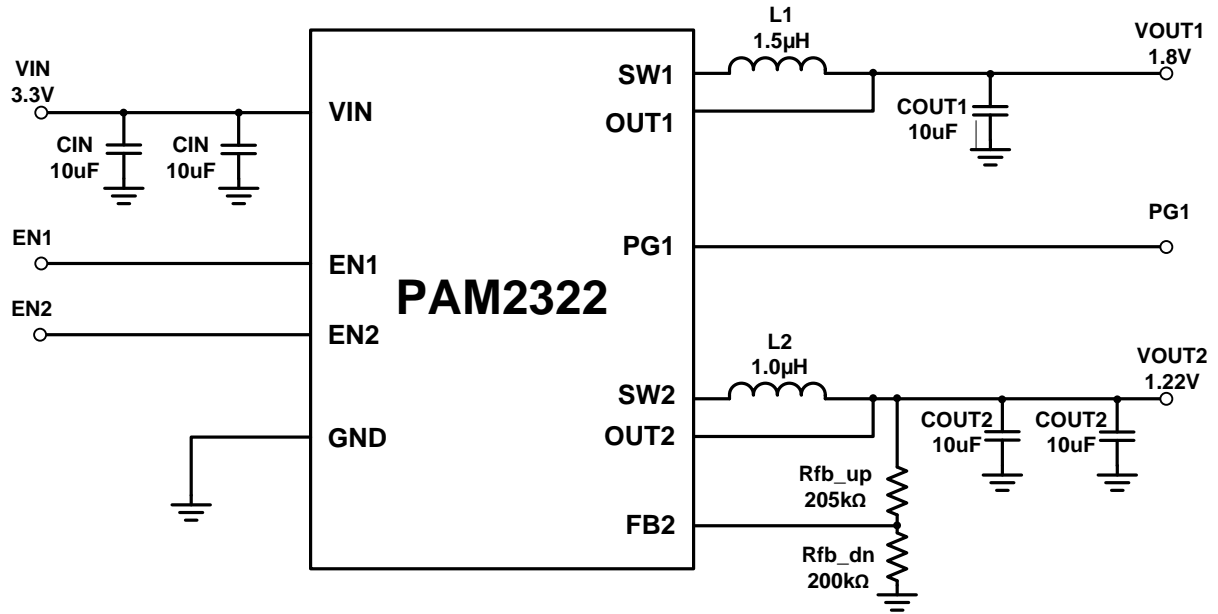

Pin Descriptions

W-FLGA2520-17	Name	Function
1, 15	SW2	Switch PIN for Output 2, PIN 1 and 15 can be connected on the PCB
2, 9, 16, 17	GND	Ground pin, PIN 2, 9, 16, 17 can be connected on the PCB
3	OUT2	Output sense pin of Output 2
4	FB2	Feedback pin for Output 2, the reference is set internally to 0.6V
5	EN2	Enable for Output 2. Pull high to enable channel 2. Pull low to disable
6	PG1	Output 1 power good indicator pin, open drain output
7	EN1	Enable for Output 1. Pull high to enable channel 1. Pull low to disable
8	OUT1	Output pin of Output 1, Channel one is internally fixed to 1.8V
10	SW1	Switch Pin for Output 1
11, 12, 13, 14	VIN	Input voltage pin. PIN 11, 12, 13, 14 can be connected on the PCB

Functional Block Diagram

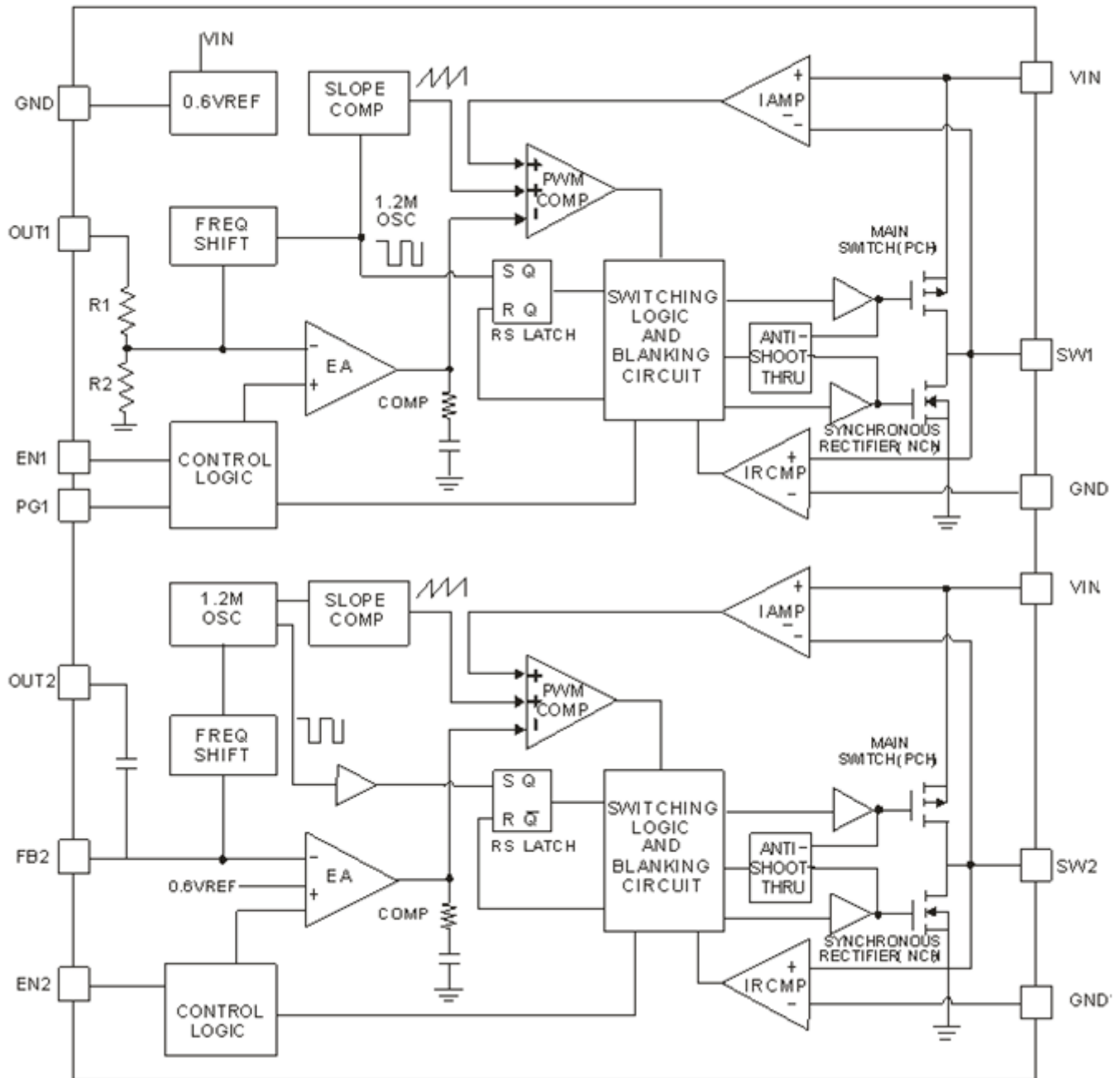

Absolute Maximum Ratings (@T_A = +25°C, unless otherwise specified.) (Note 4)

Parameter	Rating	Unit
Input Voltage	-0.3 to +6.0	V
EN1, EN2, FB2	-0.3 to V _{IN}	V
SW1 and SW2	-0.3 to (V _{IN} +0.3)	V
Junction Temperature	150	°C
Storage Temperature Range	-65 to +150	°C
Soldering Temperature	260,10sec	°C
ESD Susceptibility (Note 5)		
Human Body Model (HBM)	1.5	kV
Machine Model (MM)	150	V

- Notes: 4. Stresses greater than the 'Absolute Maximum Ratings' specified above may cause permanent damage to the device. These are stress ratings only; functional operation of the device at these or any other conditions exceeding those indicated in this specification is not implied. Device reliability may be affected by exposure to absolute maximum rating conditions for extended periods of time.
5. Semiconductor devices are ESD sensitive and may be damaged by exposure to ESD events. Suitable ESD precautions should be taken when handling and transporting these devices.

Recommended Operating Conditions (@T_A = +25°C, unless otherwise specified.)

Parameter	Rating	Unit
Supply Voltage	2.7 to 5.5	V
Ambient Temperature Range	-40 to +85	°C
Junction Temperature Range	-40 to +125	

Thermal Information

Parameter	Package	Symbol	Maximum	Unit
Thermal Resistance (Junction to Case)	W-FLGA2520-17	θ _{JC}	16	°C/W
Thermal Resistance (Junction to Ambient)	W-FLGA2520-17	θ _{JA}	80	

Electrical Characteristics ($T_A = +25^\circ\text{C}$, $V_{IN} = 3.3\text{V}$, $OUT1 = 1.8\text{V}$, $L1 = 1.5\mu\text{H}$, $OUT2 = 1.2\text{V}$, $L2 = 1.0\mu\text{H}$, unless otherwise noted.)

PARAMETER	SYMBOL	Test Conditions	MIN	TYP	MAX	UNITS	
Input Voltage Range	V_{IN}	—	2.7	3.3	5.5	V	
UVLO Threshold	V_{UVLO}	V_{IN} Rising	2.35	2.5	2.65	V	
		Hysteresis	—	400	—	mV	
Output1 Voltage Accuracy	OUT1	—	-4	—	+4	%	
OUT2 Feedback Voltage	V_{FB2}	No Load	0.591	0.60	0.609	V	
Output2 Voltage Accuracy	OUT2	V_{IN} 3.0 to 3.6V, T_A 0-70°C, VFB resistors 0.25%	-2.7	—	2.7	%	
Current Limit	I_{LIM}	Output 1	—	1.5	—	A	
		Output 2	—	3	—	A	
Quiescent Current	I_Q	No load	—	60	100	μA	
Shutdown Current	I_{SD}	$V_{EN} = 0\text{V}$	—	—	0.1	μA	
SW Leakage Current	I_{LSW}	$V_{EN} = 0\text{V}$	—	—	1	μA	
Oscillator Frequency	f_{OSC}	—	1.0	1.2	1.4	MHz	
Drain-Source On-State Resistance	$R_{DS(ON)}$	$I_{DS} = 100\text{mA}$ Output 1	P MOSFET	—	120	—	$\text{m}\Omega$
			N MOSFET	—	80	—	$\text{m}\Omega$
		$I_{DS} = 100\text{mA}$ Output 2	P MOSFET	—	50	—	$\text{m}\Omega$
			N MOSFET	—	40	—	$\text{m}\Omega$
Turn-on Time	T_s	$V_{IN} = 0$ to 3.3V, $I_o = 200\text{mA}$	—	—	1000	μs	
		$EN = 0$ to 3.3V, $I_o = 200\text{mA}$	—	—	300	μs	
Turn-off Time	T_{off}	$EN = 3.3$ to 0V, $I_o = 5\text{mA}$	—	—	7000	μs	
Turn-on Pre-charge Time	T_{chg}	$EN = 0$ to 3.3V, $I_o = 200\text{mA}$ $V_o = 1.1\text{V}$ to 1.2V	—	—	300	μs	
Turn-off Discharge Time	T_{dis}	$EN = 3.3$ to 0V, $I_o = 5\text{mA}$ $V_o = 1.2\text{V}$ to 1.1V	—	—	450	μs	
High Impedance Delay	OUT1, SW1	EN1 transitions high to low	—	—	10	μs	
	OUT2, SW2, FB2	EN2 transitions high to low	—	—	10		
EN1/EN2 Threshold High	V_{EH}	—	1.2	—	—	V	
EN1/EN2 Threshold Low	V_{EL}	—	—	—	0.4	V	
Over Temperature Protection	OTP	—	—	150	—	$^\circ\text{C}$	
OTP Hysteresis	OTH	—	—	30	—	$^\circ\text{C}$	
PG Pin Trigger Delay	—	—	—	90	—	μs	
PG Pin Threshold (Relative to V_{out})	—	—	—	+/-10	—	%	
PG Open Drain Impedance ($PG = PV_{in}$)	—	—	—	500K	—	Ω	
PG Open Drain Impedance ($PG = \text{low}$)	—	—	—	—	100	Ω	

Electrical Characteristics (T_A= +25°C, V_{IN}=3.3V, OUT1=1.8V, L1=1.5μH, OUT2=1.2V, L2=1.0μH, unless otherwise noted.) (cont.)

PARAMETER	SYMBOL	Test Conditions	MIN	TYP	MAX	UNITS
PSM Threshold	ITH	OUT1	—	100	—	mA
		OUT2	—	200	—	mA
PSM Hysteresis	IHY	OUT1	—	6	—	mA
		OUT2	—	20	—	mA
Efficiency	EffiOUT1	IOUT1= 300uA to 600uA	—	55	—	%
		IOUT1= 10mA	—	82	—	%
		IOUT1= 300mA to 400mA	—	92	—	%
	EffiOUT2	IOUT2= 200uA to 300uA	—	50	—	%
		IOUT2= 10mA	—	80	—	%
		IOUT2= 900mA to 1200mA	—	90	—	%
Load Regulation	VLDR-OUT1	IOUT1= 100mA to 500mA	—	0.05%	—	VO/mA
	VLDR-OUT2	IOUT2= 200mA to 1500mA	—	0.05%	—	VO/mA
Line Regulation	VLNR-OUT1	VIN= 3.0V to 3.6V	—	0.1%	—	VO/V
	VLNR-OUT2	VIN= 3.0V to 3.6V	—	0.1%	—	VO/V

Application Information

The typical application circuit of PAM2322AGEAR is shown on page 2. External component selection is determined by the load requirement, selecting inductors L1 and L2 first and then input capacitor CIN and output capacitor COUT.

Inductor selection

For most applications, the value of the inductor is in the range of 1μH to 3.3μH, which is chosen based on the desired current ripple. Large value inductor brings lower current ripple and small value inductor results in higher current ripple. Higher V_{IN} and V_{OUT} increase the current ripple as well shown in the following equation. For OUT1 with 1A loading current requirement, the reasonable current ripple starting point f is ΔIL = 0.4A (40% of 1A), For OUT2 with 2A loading current requirement, the reasonable current ripple starting point is ΔIL = 0.8A (40% of 2A)

$$\Delta I_L = \frac{1}{(f)(L)} V_{out} \left(1 - \frac{V_{out}}{V_{in}} \right)$$

The DC current rating of the inductor should be at least equal to the maximum load current plus half of the current ripple to prevent core saturation. A low DC-resistance inductor is better to get higher efficiency.

CIN and COUT selection

To prevent input large voltage transient, a low ESR capacitor with the maximum RMS current must be used. The maximum capacitor RMS current is given by:

$$C_{IN} \text{ required } I_{RMS} \cong I_{OMAX} \frac{[V_{OUT}(V_{IN} - V_{OUT})]^{1/2}}{V_{IN}}$$

This formula shows that I_{RMS} has the maximum value at V_{IN} = 2V_{OUT}, where I_{RMS} = I_{OUT}/2 and this worst-case is common used for design.

Application Information (cont.)

CIN and COUT selection (cont.)

The selection of Cout is driven by the requirement of effective series resistance (ESR) and the output voltage ripple ΔV_{OUT} is determined by:

$$\Delta V_{OUT} \approx \Delta I_L \left(ESR + \frac{1}{8} f C_{OUT} \right)$$

Where f is the operating frequency, COUT is output capacitance and ΔI_L is rippling current flowing through the inductor.

When output voltage is set, the output voltage ripple changes with the input voltage and is at its worst when input voltage reaches a high level.

Using Ceramic Input and Output Capacitors

Higher values, lower cost ceramic capacitors are now becoming available in smaller case sizes. Their high ripple current, high voltage rating and low ESR make them ideal for switching regulator applications. Using ceramic capacitors can achieve very low output ripple and small PCB size. X5R or X7R are preferred, because they have the better temperature and voltage characteristics.

Output Voltage Setting

PAM2322AGEAR output1 is fixed at 1.8V and cannot be adjusted. For other voltage options contact your Diodes representative.

Output2 can be adjusted based on an external connected voltage divider. The internal reference of FB2 is 0.6V (Typical). The output voltage can be found based on the following calculation. The general output voltage is given in Table 1.

$$V_{OUT2} = 0.6 \times \left(1 + \frac{R_{FB_UP}}{R_{FB_LOW}} \right)$$

Table 1: Resistor Selection for Output 2 Voltage Setting

VOUT2	Rfb_up	Rfb_low
1.22V	205k	200k
1.5V	150k	100k
1.8V	300k	150k
2.5V	380k	120k
3.3V	680k	150k

Pulse Skipping Mode (PSM) Description

When load current decreases, the peak switch current from Power-PMOS is lower than skipping current threshold and the device will enter Pulse Skipping Mode. In this mode, the device has two states, working state and idle state. Firstly, the device enters working state controlled by internal error amplifier. When the feedback voltage gets higher than internal reference voltage, the device will enter idle state with internal blocks disabled. When the feedback voltage gets lower than the internal reference voltage, the convertor will enter the working state again.

UVLO and Soft-Start

The reference and the circuit remain reset until the VIN crosses its UVLO threshold. The PAM2322AGEAR has an internal soft-start circuit that limits the in-rush current during start-up. This prevents possible voltage drops of the input voltage and eliminates an output voltage overshoot.

Application Information (cont.)

Hiccup Mode Short Circuit Control

When the converter output1 or output2 is shorted, or the device is overloaded during high-side MOSFET current-limit triggering, it will turn off the high-side MOSFET and turn on the low-side MOSFET. An internal counter is used to count the number of the current-limit triggering. The counter is reset when consecutive high-side MOSFET turn on without reaching current limit. If the current-limit condition persists, the counter fills up. The control logic then stops both high side and low side MOSFETs and waits for a hiccup period, before attempting a new soft-start sequence. The counter bit is decided by V_{FB} voltage. If $V_{FB} \leq 0.2V$, it is 3-bit counter; If $V_{FB} > 0.2V$ it is 6-bit counter. The typical hiccup mode duty cycle is 1.7%. The hiccup mode is disabled during soft-start time.

Over Temperature Protection

The internal thermal temperature protection circuitry is provided to protect the integrated circuit in the event that the maximum junction temperature is exceeded. When the junction temperature exceeds $+150^{\circ}C$, it shuts down the internal control circuit and switching power MOSFET. The PAM2322AGEAR will restart automatically under the control of soft-start circuit when the junction temperature decreases to $+120^{\circ}C$.

Power Good Flag

PG1 pin is power good indicator. The output of this pin is an open drain with internal pull up resistor to VIN. PG is pulled up to VIN when the output1 voltage (1.8V) is within 10% of the regulation level, otherwise it is low.

Typical Performance Characteristics (TA= +25°C, VIN=3.3V, OUT1=1.8V, L=1.5μH, OUT2=1.2V,L=1.0μH, unless otherwise noted.)

OUT1 Efficiency vs. Output Current

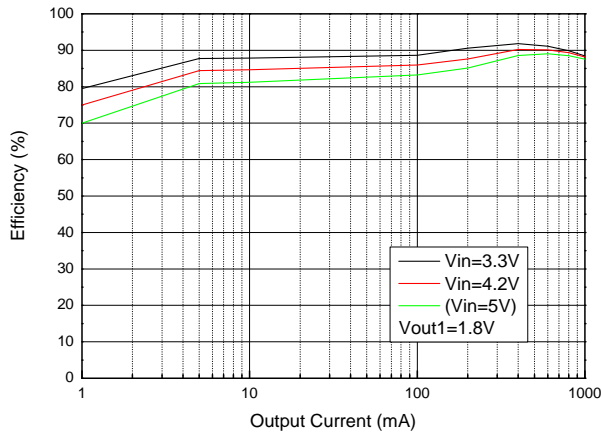

OUT2 Efficiency vs. Output Current

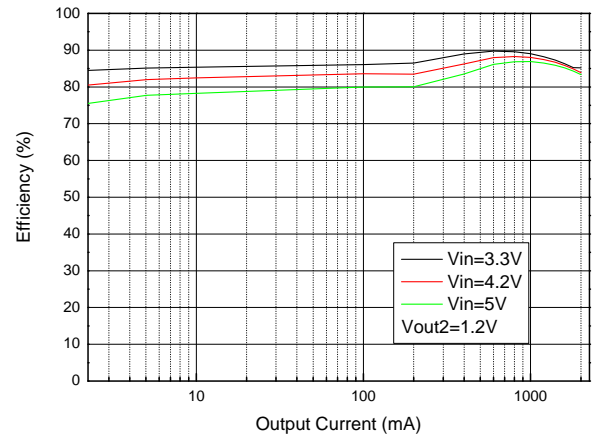

OUT1 Output Voltage vs. Output Current

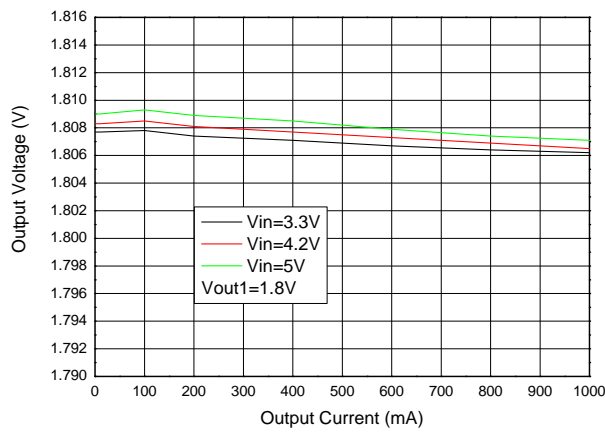

OUT2 Output Voltage vs. Output Current

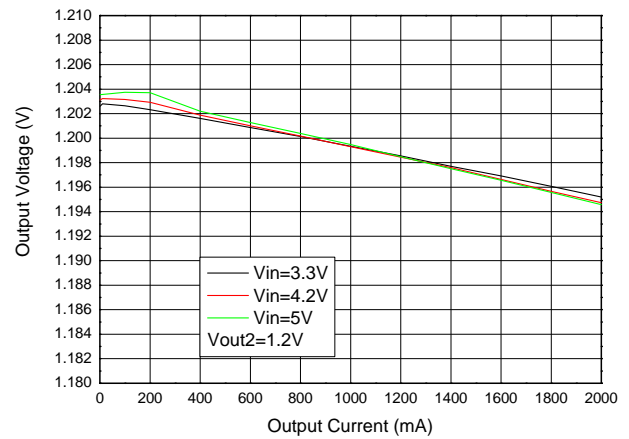

OUT1 Line Regulation vs. Input Voltage

OUT2 Line Regulation vs. Input Voltage

Typical Performance Characteristics (TA= +25°C, VIN=3.3V, OUT1=1.8V, L=1.5μH, OUT2=1.2V, L=1.0μH, unless otherwise noted.)

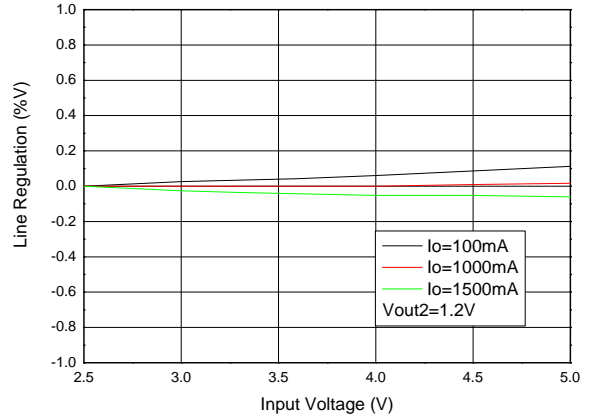
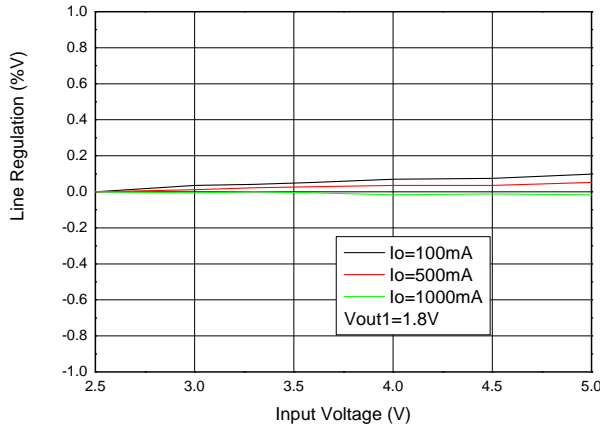

Dynamic Supply Current vs. Temperature

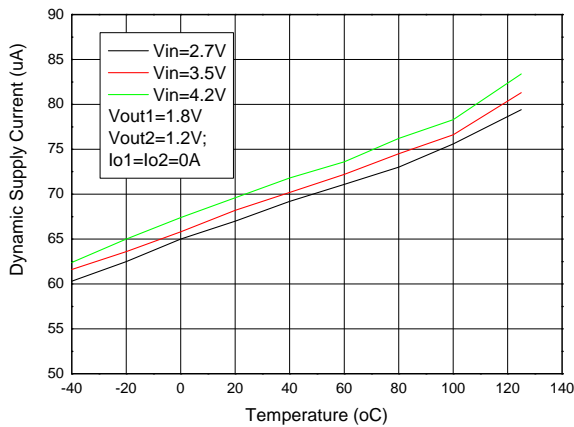

Dynamic Supply Current vs. Input Current

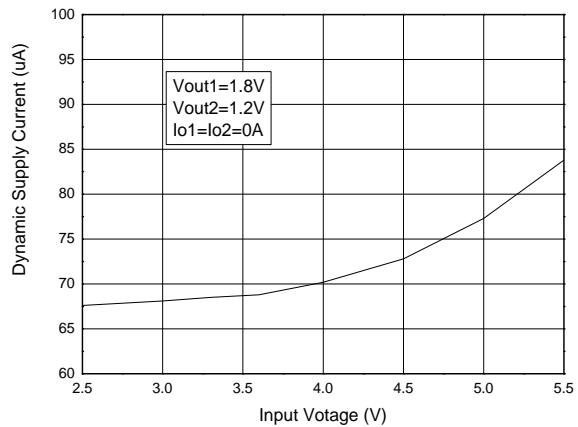

PMOS Rdson vs. Temperature

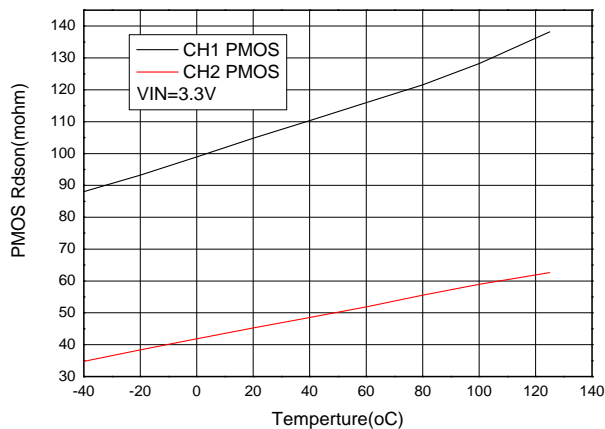

NMOS Rdson vs. Temperature

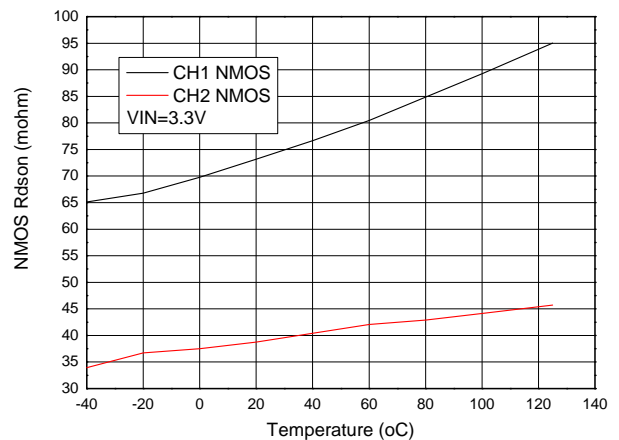

Typical Performance Characteristics (TA= +25°C, VIN=3.3V, OUT1=1.8V, L=1.5μH, OUT2=1.2V, L=1.0μH, unless otherwise noted.)

Enable turn on

Vin=3.3V, Vout1=1.8V, Vout2=1.2V, Io1=1A, Io2=2A

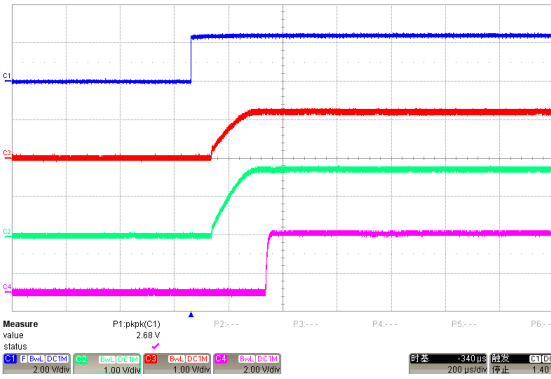

(CH1=Enable; CH2=Vout2; CH3=Vout1; CH4=PG)

Enable turn off

Vin=3.3V, Vout1=1.8V, Vout2=1.2V, Io1=1A, Io2=2A

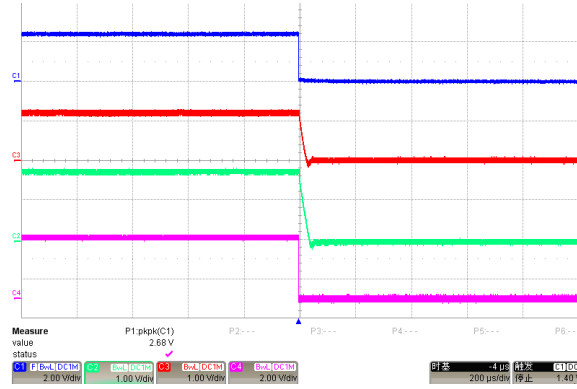

(CH1=Enable; CH2=Vout2; CH3=Vout1; CH4=PG)

Output Ripple

Vin=3.3V, Vout2=1.2V, Io2=0A

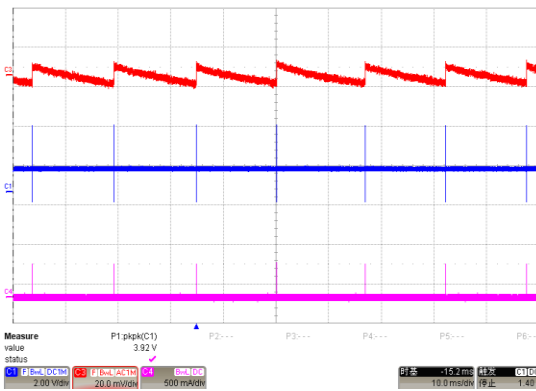

(CH1=Switch; CH3=Output Voltage; CH4=Inductor current)

Output Ripple

Vin=3.3V, Vout2=1.2V, Io2=1A

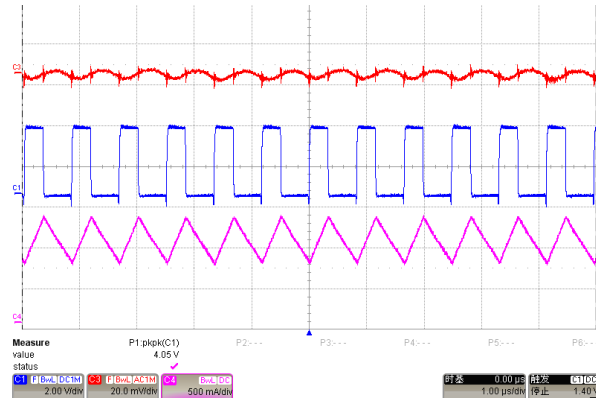

(CH1=Switch; CH3=Output Voltage; CH4=Inductor current)

Output Short Protection

Vin=3.3V, Vout2=1.2V, Io2=1A

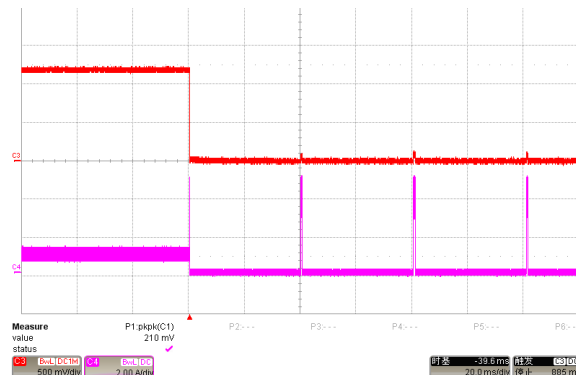

(CH3=Output Voltage; CH4=Inductor Current)

Output Short Recovery

Vin=3.3V, Vout2=1.2V, Io2=1A

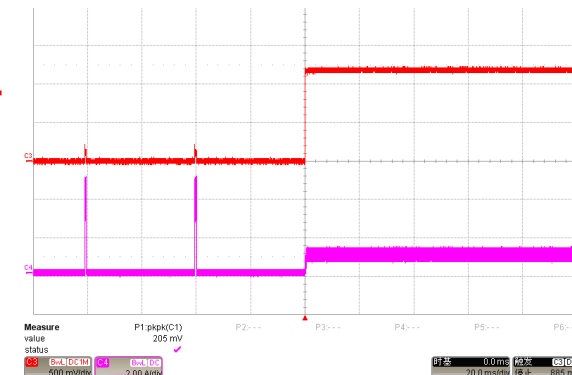

(CH3=Output Voltage; CH4=Inductor Current)

Ordering Information

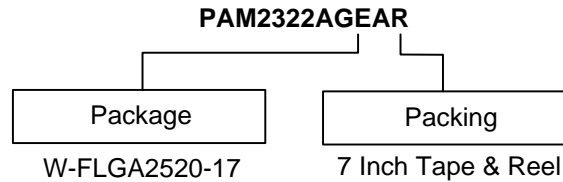

Part Number	Marking	Package Type	Standard Package
PAM2322AGEAR	CRA XYW	W-FLGA2520-17	3,000 Units/Tape & Reel

Marking Information

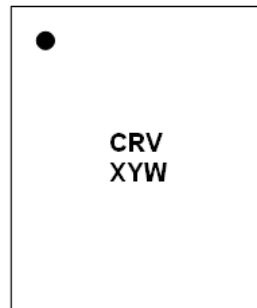

CR: Product Code of PAM2322
V: Output Voltage
X: Internal Code
Y: Year
W: Week

Package Outline Dimensions (All dimensions in mm.)

W-FLGA2520-17

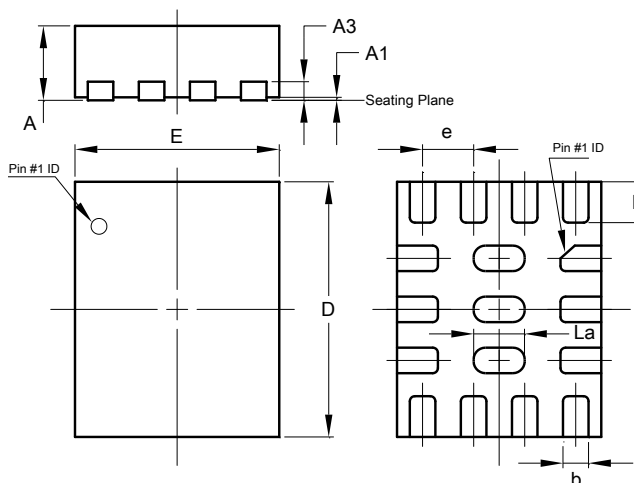

W-FLGA2520-17		
Dim	Min	Max
A	0.700	0.800
A1	0	0.050
A3	0.0203REF	
b	0.200	0.300
D	2.420	2.580
E	1.950	2.050
e	0.500TYP	
L	0.320	0.480
La	0.424	0.576
All Dimensions in mm		

Recommended Pad Layout

W-FLGA2520-17

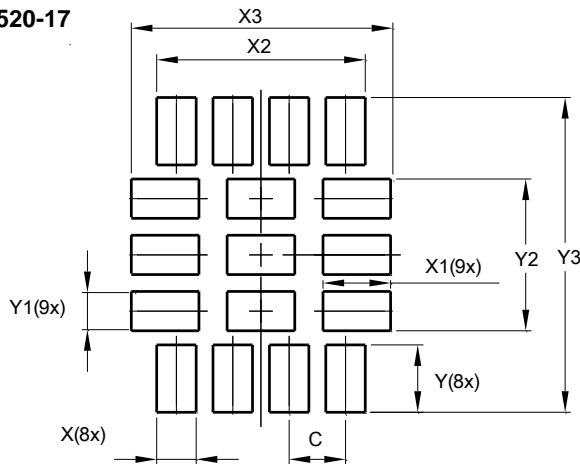

Dimensions	Value (in mm)
C	0.500
X	0.350
X1	0.600
X2	1.850
X3	2.320
Y	0.600
Y1	0.350
Y2	1.350
Y3	2.800

IMPORTANT NOTICE

DIODES INCORPORATED MAKES NO WARRANTY OF ANY KIND, EXPRESS OR IMPLIED, WITH REGARDS TO THIS DOCUMENT, INCLUDING, BUT NOT LIMITED TO, THE IMPLIED WARRANTIES OF MERCHANTABILITY AND FITNESS FOR A PARTICULAR PURPOSE (AND THEIR EQUIVALENTS UNDER THE LAWS OF ANY JURISDICTION).

Diodes Incorporated and its subsidiaries reserve the right to make modifications, enhancements, improvements, corrections or other changes without further notice to this document and any product described herein. Diodes Incorporated does not assume any liability arising out of the application or use of this document or any product described herein; neither does Diodes Incorporated convey any license under its patent or trademark rights, nor the rights of others. Any Customer or user of this document or products described herein in such applications shall assume all risks of such use and will agree to hold Diodes Incorporated and all the companies whose products are represented on Diodes Incorporated website, harmless against all damages.

Diodes Incorporated does not warrant or accept any liability whatsoever in respect of any products purchased through unauthorized sales channel. Should Customers purchase or use Diodes Incorporated products for any unintended or unauthorized application, Customers shall indemnify and hold Diodes Incorporated and its representatives harmless against all claims, damages, expenses, and attorney fees arising out of, directly or indirectly, any claim of personal injury or death associated with such unintended or unauthorized application.

Products described herein may be covered by one or more United States, international or foreign patents pending. Product names and markings noted herein may also be covered by one or more United States, international or foreign trademarks.

This document is written in English but may be translated into multiple languages for reference. Only the English version of this document is the final and determinative format released by Diodes Incorporated.

LIFE SUPPORT

Diodes Incorporated products are specifically not authorized for use as critical components in life support devices or systems without the express written approval of the Chief Executive Officer of Diodes Incorporated. As used herein:

A. Life support devices or systems are devices or systems which:

1. are intended to implant into the body, or
2. support or sustain life and whose failure to perform when properly used in accordance with instructions for use provided in the labeling can be reasonably expected to result in significant injury to the user.

B. A critical component is any component in a life support device or system whose failure to perform can be reasonably expected to cause the failure of the life support device or to affect its safety or effectiveness.

Customers represent that they have all necessary expertise in the safety and regulatory ramifications of their life support devices or systems, and acknowledge and agree that they are solely responsible for all legal, regulatory and safety-related requirements concerning their products and any use of Diodes Incorporated products in such safety-critical, life support devices or systems, notwithstanding any devices- or systems-related information or support that may be provided by Diodes Incorporated. Further, Customers must fully indemnify Diodes Incorporated and its representatives against any damages arising out of the use of Diodes Incorporated products in such safety-critical, life support devices or systems.

Copyright © 2014, Diodes Incorporated

www.diodes.com