

# PBD 3535 DTMF Generator

## Description

PBD 3535 is a monolithic integrated DTMF generator intended for use in a telephone set in parallel with an electronic speech circuit. The DC characteristic to the line is set by the speech circuit. PBD 3535 gives a mute signal when sending. The circuit fulfills the CEPT specification. Optional signal levels can be set by resistors. The circuit operates with a single contact matrix keyboard. Interfacing with a computer is also possible.

## Key Features

- Operates with a standard crystal at 3.58 MHz
- Wide operating line voltage and current range
- Levels from the high and low frequency group can be adjusted separately
- No individual level adjustment is necessary for every circuit
- The signal levels are stabilized against variations in temperature and line voltage
- Short start-up time
- All tones can be generated separately for testing
- The number of external components is minimized
- Easy PC board layout; all keyboard connections on one side of the circuit
- Internal protection of all inputs
- $I^2L$  process ensures good parameter tolerances

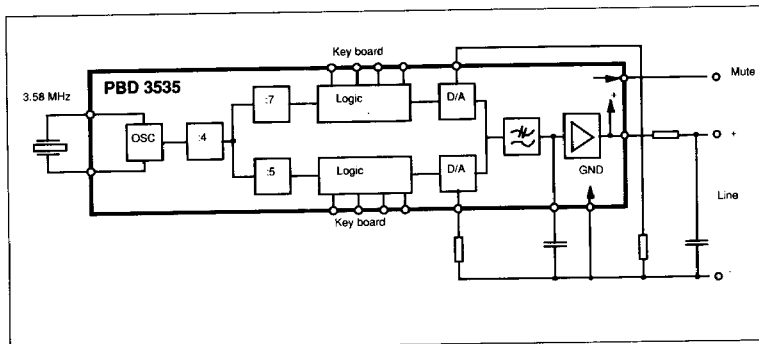
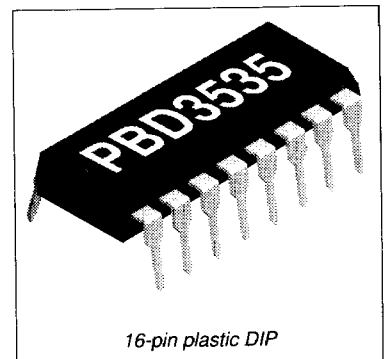

Figure 1. Functional diagram.



### Maximum Ratings

Maximum ratings over operating free-air temperature range (unless otherwise stated).

Parameter	Symbol	Min	Max	Unit
Max. continuous line voltage	$V_{Line}$	0	13	V
Peak line voltage Pulse time = 2s	$V_{Line}$	0	20	V
Pulse time = 20ms	$V_{Line}$	0	22	V
Junction temperature	$T_j$		150	°C
Operation ambient temperature	$T_{Amb}$	-20	70	°C
Storage temperature	$T_{Stg}$	-55	150	°C

### Recommended Operating Conditions

Parameter	Symbol	Min	Typ	Max	Unit
Line Voltage	$V_{Line}$	4.3		9	V
Ambient temperature	$T_{Amb}$	-20	25	70	°C

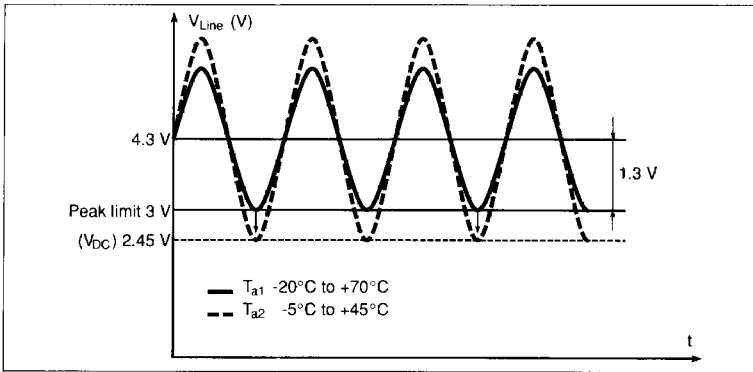

Figure 2. Allowable signal amplitude.

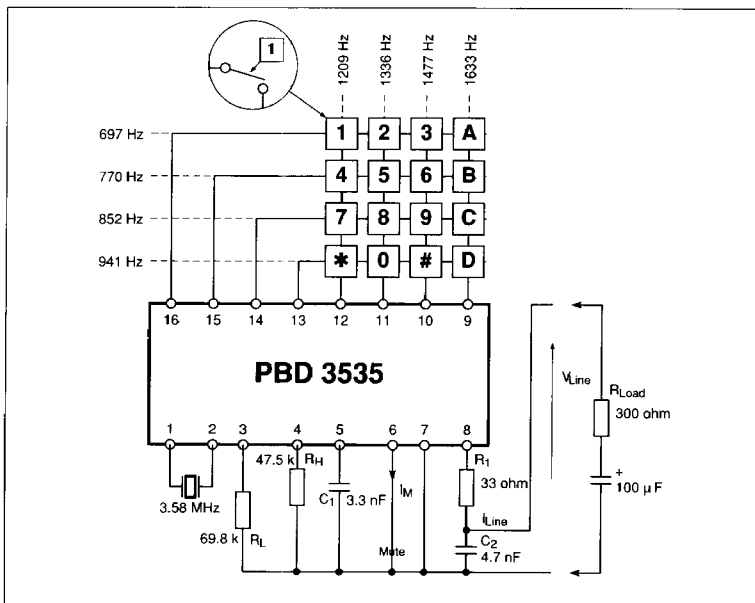

Figure 3. Test circuit.

## Electrical Characteristics

Electrical characteristics over recommended operating conditions. Test Circuit see fig. 3.

Parameter	Ref. fig.	Conditions	Min	Typ	Max	Unit
Line voltage, $V_{Line}$		Tone generation DC level at 1.3 $V_p$ AC signal (see fig.2)	4.3		9	V
DC voltage below AC voltage, $V_{DC}$	2	At tone generation	3.0			V
		At tone generation -5 °C + 45 °C	2.45			V
Line voltage, $V_{Line}$		Stand-by DC level at 2.0 $V_p$ AC signal	4.3		9	V
Line current, $I_{Line}$		$V_{Line} = 4.3$ V Standby-by: no key pressed			250	$\mu$ A
		Operating current			10	mA
Mute current, $I_M$		One or more keys pressed	125			$\mu$ A
Key resistance, $R_K$		Key circuit closed			1	kohm
		Keys open (16 contacts)	1			Mohm
Frequency, $T_f$		$f_{Osc} = 3.5795$ MHz				
Low		$f_1 = 697$ Hz	-1	+0.32	+1	%
		$f_2 = 770$ Hz	-1	+0.02	+1	%
		$f_3 = 852$ Hz	-1	+0.03	+1	%
		$f_4 = 941$ Hz	-1	-0.11	+1	%
High		$f_5 = 1209$ Hz	-1	-0.03	+1	%
		$f_6 = 1336$ Hz	-1	-0.03	+1	%
		$f_7 = 1477$ Hz	-1	-0.68	+1	%
		$f_8 = 1633$ Hz	-1	-0.36	+1	%
Signal Level high, $V_{High}$		$R_H = 47.5$ Kohm	-11	-9	-7	dBm
		$R_H = 33.2$ kohm	-8	-6	-4	dBm
		$R_H = 26.1$ kohm	-6	-4	-2	dBm
Signal level low, $V_{Low}$		$R_L = 69.8$	-13	-11	-9	dBm
		$R_L = 48.7$ kohm	-10	-8	-6	dBm
		$R_L = 39.2$ kohm	-8	-6	-4	dBm
Ratio signal level (high freq / low freq)			1	2	3	dB
$V_{High} / V_{Low}$						kohm
Impedance to line, $Z_T$		At tone generation	6			kohm
$Z_S$		At stand-by	50			kohm
Total Harmonic distortion, D		Normal operation			-31	dBm
		Stand-By			-80	dBm
Harmonics, H		300-3400 Hz			-33	dBm
		3.4 kHz to 50 kHz			(Note 1)	dBm
		>50 kHz			-80	dBm
Start-up time, $t_s$		Output level within 1 dB of final level		3	5	ms

### Notes:

1. Single tone distortion is less than  $(-33 - 40 \cdot \log \frac{f}{3400})$  dBm.

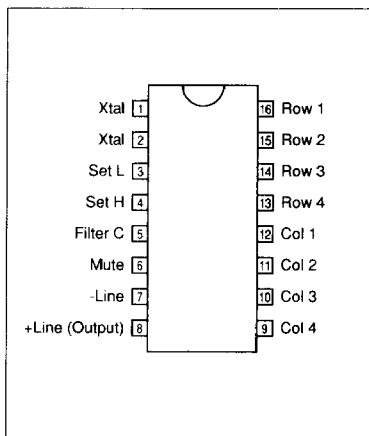

Figure 4. Pin configuration.

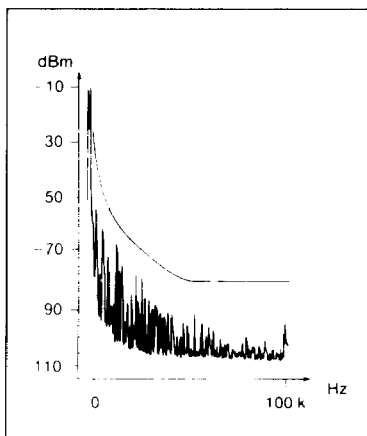

Figure 5. Frequency spectrum of the tone pairs at the output.

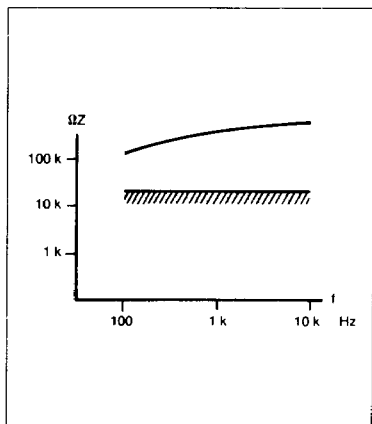

Figure 6. Typical impedance at standby.

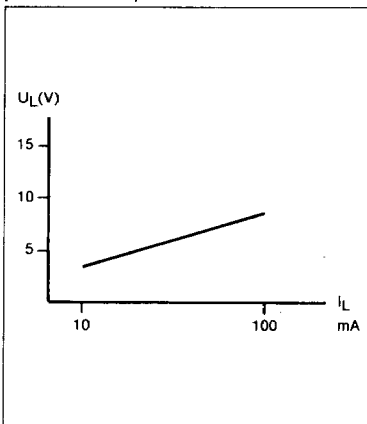

Figure 7. DC Characteristic with speech circuit PBL 3726/6.

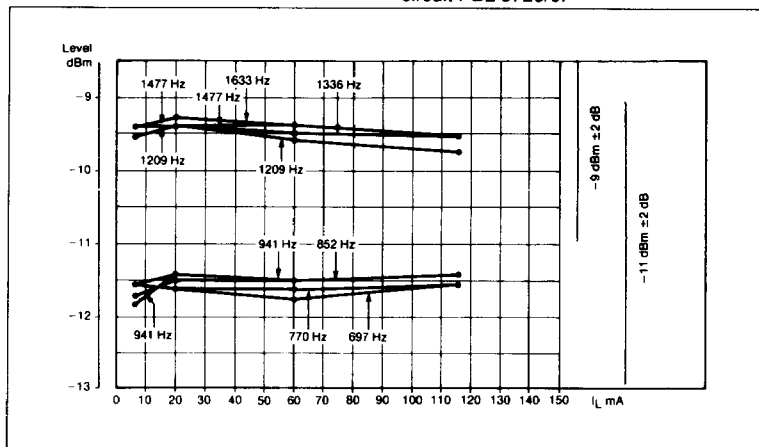

Figure 8. Tone level vs. line current.

### Functional Description

The circuit generates through digital synthesis the 8-tones which are needed for DTMF-signalling on a telephone line. A 3.5795 MHz TV crystal is used as frequency standard.

The crystal oscillator frequency is divided first by 4 and then by 7 for the low frequency group and by 5 for the high frequency group.

The generation of the two tones which signify the specific digit is activated by connecting one input in one group to an input in the other group. Each tone is generated digitally with I<sup>2</sup>L logic. Each digital signal is fed into an 4-bit digital / analog converter that generates a sinus shaped signal 15 steps in amplitude and 30 steps in time for each cycle.

The step length is varied for each step but also fro each tone to obtain a sinus signal with a low overtone content as possible and using as simple filter as possible. The result is according to the CEPT specification.

Reference to the signal amplitude is a band gap-reference voltage of 1.22 V. The additive signal from the two D/A converters is filtered in an internal filter and after that in an external filter stage.

The signal is fed into the output amplifier and directly to the telephone line. The output amplifier that is a current generator, generates the output signal to the line as current and has a high output impedance.

The circuit is powered by current generators from the + line and most of it is switched on first when the circuit is activated. The keyboard is sensed by DC-currents which gives good possibilities to use effective RFI suppression methods.

If two or more keys are pressed, no tones other than the basic eight are generated.

All tones can be generated separately. When testing a circuit by connecting one input from the high frequency group to one input in the low frequency group plus shorting pin 3 or pin 4 to ground pin 7, one single tone is generated (high and low frequency, respectively).

The absolute signal levels can be adjusted with R<sub>L</sub> and R<sub>in</sub>, but there is no need for individual adjustment on every circuit. The signal level is stabilized against variations in temperature and line current.

Pause and signal time are determined externally from the keyboard.

Allowed leakage in keyboard is 1 Mohm. Typical threshold is 100kΩ.

The circuit is made to work properly with electronic speech circuits such as Ericsson Components' PBL 3726 or PBL 3781.

Component function:

- R1: Protecting resistor
- RL: Signal level (low)
- RH: Signal level (high)
- C1: Low pass filter
- C2: Radio frequency suppression (if used together with speech circuit with radio suppression already included in the external components, like PBL 3726, C<sub>2</sub> is not necessary).

To find suitable resistor values for R<sub>H</sub> and R<sub>L</sub> to get the desired tone levels the following formula can be used for a preliminary calculation. Please note that in R<sub>Load</sub> (f=1.4 kHz) and R<sub>Load</sub> (f=800 Hz) both the impedance of the line and the impedance of the speech circuit are included. V<sub>High</sub> and V<sub>Low</sub> are the desired high and low frequency levels, in dBm.

$$R_{High} = 56.2 \cdot R_{Load} (f = 1.4 \text{ kHz}) \cdot 10^{-(V_{High} / 20)}$$

$$R_{Low} = 65.6 \cdot R_{Load} (f = 800 \text{ Hz}) \cdot 10^{-(V_{Low} / 20)}$$

The current consumption within PBD 3535 can be reduced with a resistor connected in parallel with C<sub>1</sub>. If the current reduction is made too large, the output signal will be distorted by clipping.

In applications where the DTMF generator is powered, without a speech circuit, directly from the telephone line, PBD 3535 can be used with a DC regulator as described in fig 11.

These schematics give a DC regulator for the range 16-100 mA with an output impedance that is a compromise between 600 ohm and 900 ohm in parallel with 30 nF. The zener diode is used to ensure a fast start-up time.

For telephone systems with voltage supply (instead of current supply) for the telephone line and where the telephone set is supposed to work as a current source, PBD 3535 can be connected with a series regulator as shown in fig 12.

These schematics are working in the area 5-36 V and the output impedance is matched against 600 ohm.

PBD 3535 can also be controlled by a microprocessor (see fig 13). The negative branch of the microprocessor

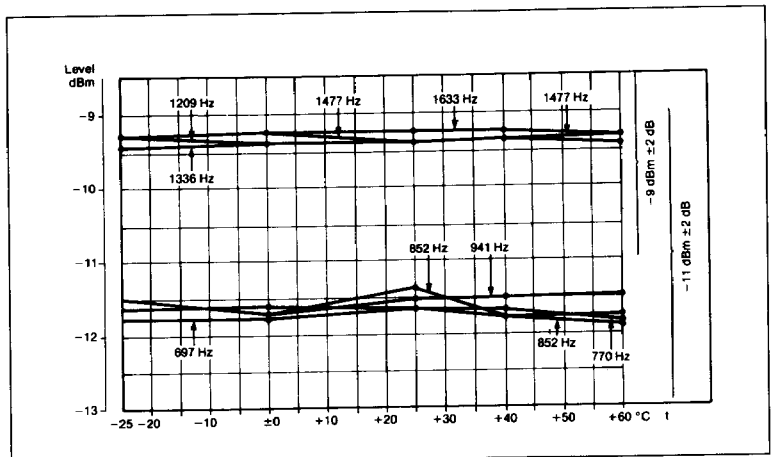

Figure 9. Tone levels vs. temperature.

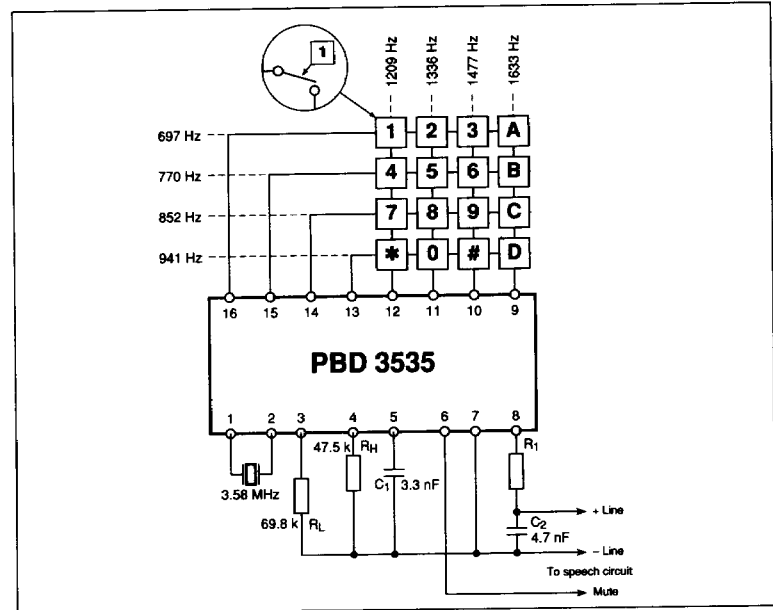

Figure 10. Typical application.

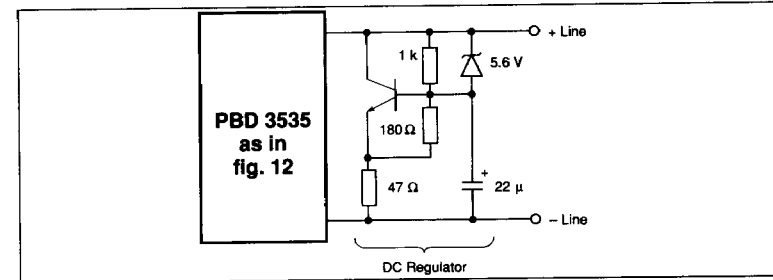

Figure 11. External DC regulator.

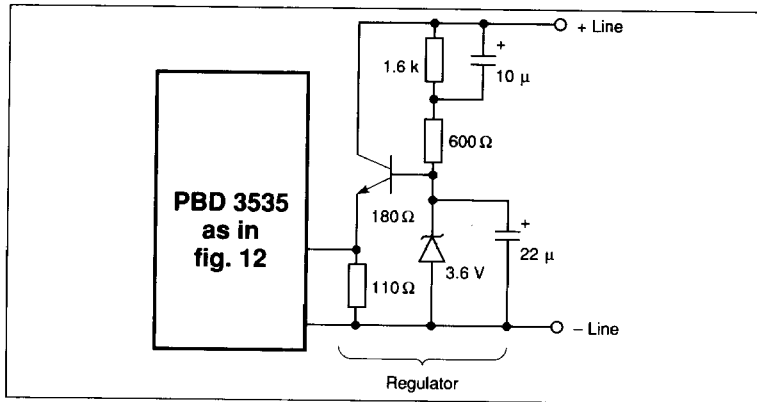

Figure 12. External constant current source line interface.

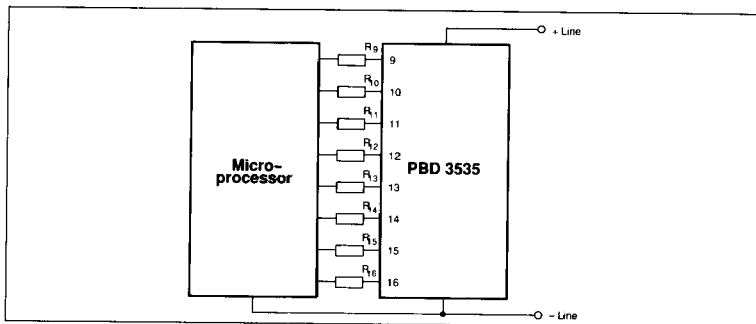

Figure 13. Microcomputer interface.

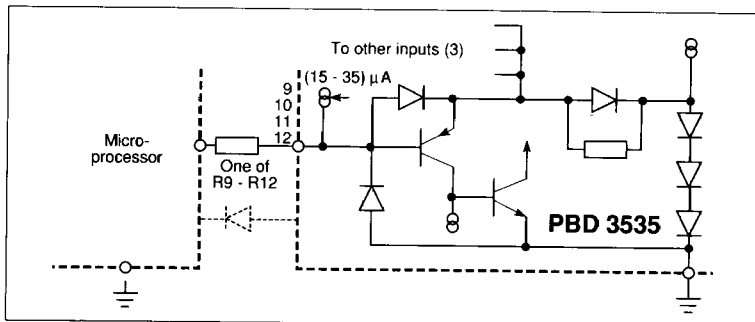

Figure 14. High frequency group resistors to microprocessor.

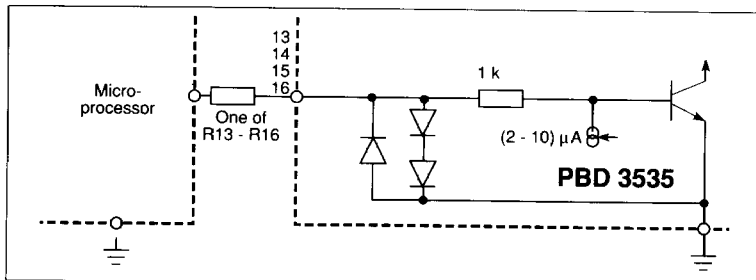

Figure 15. Low frequency group resistors to microprocessor.

voltage supply is connected to pin 7 of PBD 3535 and the inputs are connected with resistors. For tone-generating one input of the low group (pins 13-16) is high and one input of the high group (pins 9-12) is low. When an input of the high group (pins 9-12) is low, PBD 3535 is activated and the mute output is put in high state.

The resistors  $R_9$ ,  $R_{10}$ ,  $R_{11}$ , and  $R_{12}$  have two functions.

- When at low input level, ensure that the input does not get below +0.2 V. This must not occur.
- When the input level is high, limit the current. Too high current will interfere with the functions of the other three inputs (the resistors can be exchanged with diodes as shown in figure 14).

Example: The logic states vary from 0 V to +3 V. Suitable resistor value is 27 kohm (see fig 14).

The two functions of the resistor  $R_{13}$ ,  $R_{14}$ ,  $R_{15}$  and  $R_{16}$  are:

- To raise the OFF/ON voltage
- To limit the current when the input levels are high

Example: The logic states vary from 0 V to +3 V. Suitable resistor value is 69 kohm (see fig 15).

In some telephone instrument designs a click can be heard in the receiver when a button is pressed down for tone signalling. In some applications this has been found desirable as a feedback but in others the effect is not so desirable. To suppress the click effect an RC network as seen in fig 16 can be applied. A capacitor of 47 nF halves the loudness of the click and a capacitor of 4.7  $\mu$ F totally cancels the click effect (see fig 17).

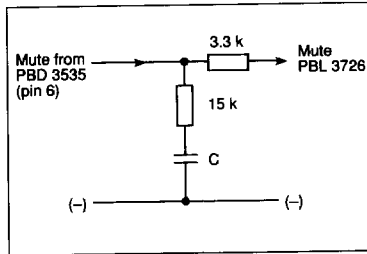

Figure 16. Click suppression circuit.

**Ordering Information**

Package	Temp. Range	Part No.
Plastic DIP	-20 to +70°C	PBD 3535N

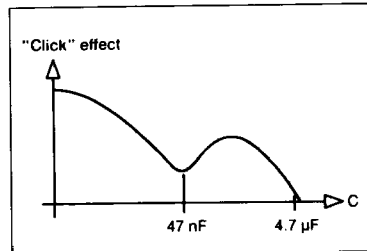

Figure 17. Click effect vs. value of C.