

# PBSS4041PZ

60 V, 5.7 A PNP low  $V_{CEsat}$  (BISS) transistor

Rev. 01 — 31 March 2010

Product data sheet

## 1. Product profile

### 1.1 General description

PNP low  $V_{CEsat}$  Breakthrough In Small Signal (BISS) transistor in a SOT223 (SC-73) medium power Surface-Mounted Device (SMD) plastic package.

NPN complement: PBSS4041NZ.

### 1.2 Features and benefits

- Very low collector-emitter saturation voltage  $V_{CEsat}$
- High collector current capability  $I_C$  and  $I_{CM}$
- High collector current gain ( $h_{FE}$ ) at high  $I_C$
- High energy efficiency due to less heat generation
- AEC-Q101 qualified
- Smaller required Printed-Circuit Board (PCB) area than for conventional transistors

### 1.3 Applications

- Loadswitch
- Battery-driven devices
- Power management
- Charging circuits
- Power switches (e.g. motors, fans)

### 1.4 Quick reference data

Table 1. Quick reference data

Symbol	Parameter	Conditions	Min	Typ	Max	Unit
$V_{CEO}$	collector-emitter voltage	open base	-	-	-60	V
$I_C$	collector current		-	-	-5.7	A
$I_{CM}$	peak collector current	single pulse; $t_p \leq 1$ ms	-	-	-15	A
$R_{CEsat}$	collector-emitter saturation resistance	$I_C = -5$ A; $I_B = -500$ mA	[1] -	29	43.5	m $\Omega$

[1] Pulse test:  $t_p \leq 300$   $\mu$ s;  $\delta \leq 0.02$ .



## 2. Pinning information

Table 2. Pinning

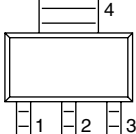
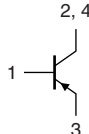
Pin	Description	Simplified outline	Graphic symbol
1	base		
2	collector		
3	emitter		
4	collector		

sym028

## 3. Ordering information

Table 3. Ordering information

Type number	Package		
	Name	Description	Version
PBSS4041PZ	SC-73	plastic surface-mounted package with increased heat sink; 4 leads	SOT223

## 4. Marking

Table 4. Marking codes

Type number	Marking code
PBSS4041PZ	PB4041PZ

## 5. Limiting values

Table 5. Limiting values

In accordance with the Absolute Maximum Rating System (IEC 60134).

Symbol	Parameter	Conditions	Min	Max	Unit
$V_{CBO}$	collector-base voltage	open emitter	-	-60	V
$V_{CEO}$	collector-emitter voltage	open base	-	-60	V
$V_{EBO}$	emitter-base voltage	open collector	-	-5	V
$I_C$	collector current		-	-5.7	A
$I_{CM}$	peak collector current	single pulse; $t_p \leq 1$ ms	-	-15	A
$I_B$	base current		-	-1	A

**Table 5. Limiting values ...continued**

In accordance with the Absolute Maximum Rating System (IEC 60134).

Symbol	Parameter	Conditions	Min	Max	Unit
$P_{tot}$	total power dissipation	$T_{amb} \leq 25\text{ }^{\circ}\text{C}$	[1] -	770	mW
			[2] -	1700	mW
			[3] -	2600	mW
$T_j$	junction temperature		-	150	$^{\circ}\text{C}$
$T_{amb}$	ambient temperature		-55	+150	$^{\circ}\text{C}$
$T_{stg}$	storage temperature		-65	+150	$^{\circ}\text{C}$

- [1] Device mounted on an FR4 PCB, single-sided copper, tin-plated and standard footprint.  
 [2] Device mounted on an FR4 PCB, single-sided copper, tin-plated, mounting pad for collector 6 cm<sup>2</sup>.  
 [3] Device mounted on a ceramic PCB, Al<sub>2</sub>O<sub>3</sub>, standard footprint.

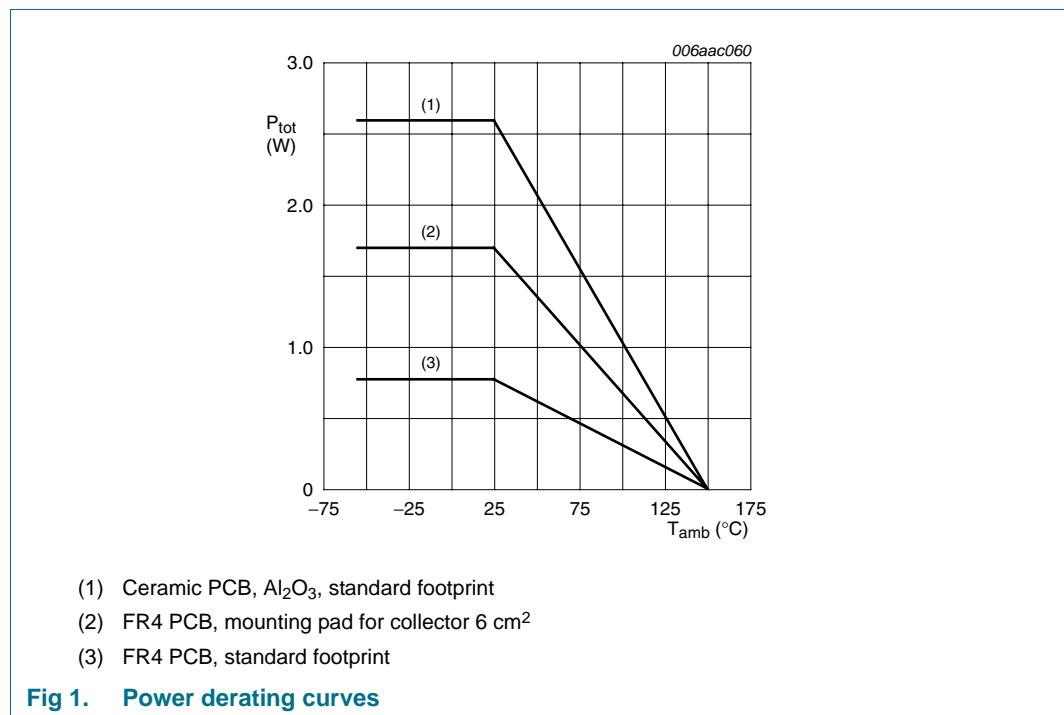

## 6. Thermal characteristics

**Table 6. Thermal characteristics**

Symbol	Parameter	Conditions	Min	Typ	Max	Unit	
$R_{th(j-a)}$	thermal resistance from junction to ambient	in free air	[1]	-	-	160	K/W
			[2]	-	-	75	K/W
			[3]	-	-	50	K/W
$R_{th(j-sp)}$	thermal resistance from junction to solder point		-	-	11	K/W	

[1] Device mounted on an FR4 PCB, single-sided copper, tin-plated and standard footprint.

[2] Device mounted on an FR4 PCB, single-sided copper, tin-plated, mounting pad for collector 6 cm<sup>2</sup>.

[3] Device mounted on a ceramic PCB, Al<sub>2</sub>O<sub>3</sub>, standard footprint.

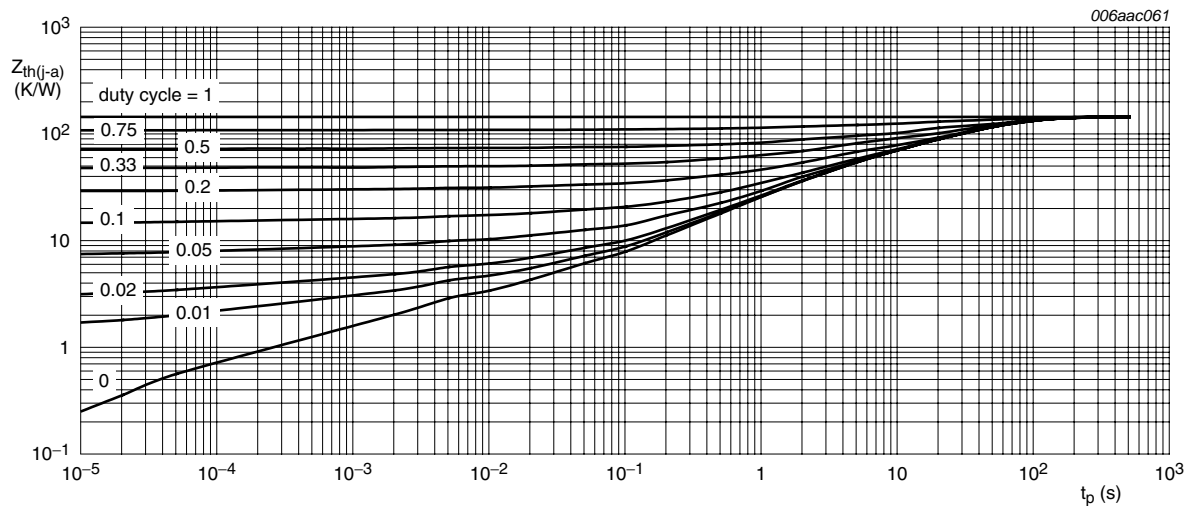

FR4 PCB, standard footprint

**Fig 2. Transient thermal impedance from junction to ambient as a function of pulse duration; typical values**

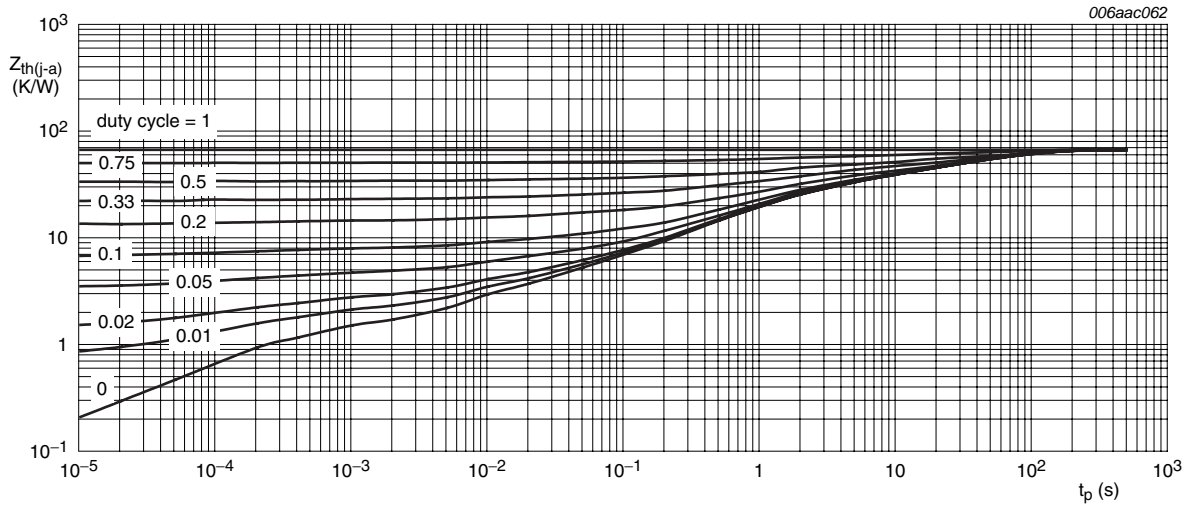

FR4 PCB, mounting pad for collector 6 cm<sup>2</sup>

**Fig 3. Transient thermal impedance from junction to ambient as a function of pulse duration; typical values**

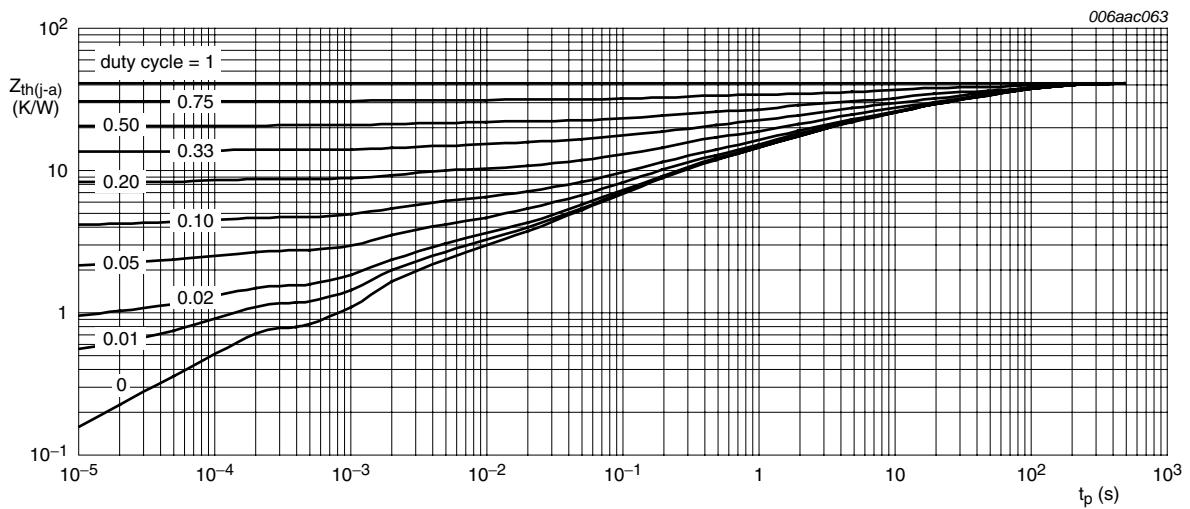

Ceramic PCB, Al<sub>2</sub>O<sub>3</sub>, standard footprint

**Fig 4. Transient thermal impedance from junction to ambient as a function of pulse duration; typical values**

## 7. Characteristics

**Table 7. Characteristics**
 $T_{amb} = 25\text{ }^{\circ}\text{C}$  unless otherwise specified.

Symbol	Parameter	Conditions	Min	Typ	Max	Unit	
$I_{CBO}$	collector-base cut-off current	$V_{CB} = -60\text{ V}; I_E = 0\text{ A}$	-	-	-100	nA	
		$V_{CB} = -60\text{ V}; I_E = 0\text{ A}; T_j = 150\text{ }^{\circ}\text{C}$	-	-	-55	$\mu\text{A}$	
$I_{CES}$	collector-emitter cut-off current	$V_{CE} = -48\text{ V}; V_{BE} = 0\text{ V}$	-	-	-100	nA	
$I_{EBO}$	emitter-base cut-off current	$V_{EB} = -5\text{ V}; I_C = 0\text{ A}$	-	-	-100	nA	
$h_{FE}$	DC current gain		[1]				
		$V_{CE} = -2\text{ V}; I_C = -500\text{ mA}$	200	300	-		
		$V_{CE} = -2\text{ V}; I_C = -1\text{ A}$	200	300	-		
		$V_{CE} = -2\text{ V}; I_C = -2\text{ A}$	200	300	-		
		$V_{CE} = -2\text{ V}; I_C = -4\text{ A}$	150	250	-		
		$V_{CE} = -2\text{ V}; I_C = -6\text{ A}$	120	200	-		
$V_{CEsat}$	collector-emitter saturation voltage		[1]				
		$I_C = -1\text{ A}; I_B = -50\text{ mA}$	-	-42	-63	mV	
		$I_C = -1\text{ A}; I_B = -10\text{ mA}$	-	-82	-125	mV	
		$I_C = -2\text{ A}; I_B = -40\text{ mA}$	-	-98	-150	mV	
		$I_C = -4\text{ A}; I_B = -200\text{ mA}$	-	-130	-195	mV	
		$I_C = -4\text{ A}; I_B = -400\text{ mA}$	-	-115	-175	mV	
		$I_C = -6\text{ A}; I_B = -300\text{ mA}$	-	-190	-285	mV	
$R_{CEsat}$	collector-emitter saturation resistance	$I_C = -5\text{ A}; I_B = -500\text{ mA}$	[1]	-	29	43.5	$\text{m}\Omega$
$V_{BEsat}$	base-emitter saturation voltage	$I_C = -1\text{ A}; I_B = -100\text{ mA}$	[1]	-	-0.82	-0.9	V
		$I_C = -4\text{ A}; I_B = -400\text{ mA}$	[1]	-	-0.98	-1.05	V
$V_{BEon}$	base-emitter turn-on voltage	$V_{CE} = -2\text{ V}; I_C = -2\text{ A}$	[1]	-	-0.74	-0.85	V
$t_d$	delay time	$V_{CC} = -12.5\text{ V};$	-	60	-	ns	
$t_r$	rise time	$I_C = -1\text{ A}; I_{Bon} = -0.05\text{ A};$	-	60	-	ns	
$t_{on}$	turn-on time	$I_{Boff} = 0.05\text{ A}$	-	120	-	ns	
$t_s$	storage time		-	530	-	ns	
$t_f$	fall time		-	100	-	ns	
$t_{off}$	turn-off time		-	630	-	ns	
$f_T$	transition frequency	$V_{CE} = -10\text{ V};$ $I_C = -100\text{ mA};$ $f = 100\text{ MHz}$	-	110	-	MHz	
$C_c$	collector capacitance	$V_{CB} = -10\text{ V};$ $I_E = I_e = 0\text{ A}; f = 1\text{ MHz}$	-	85	-	pF	

[1] Pulse test:  $t_p \leq 300\text{ }\mu\text{s}; \delta \leq 0.02$ .

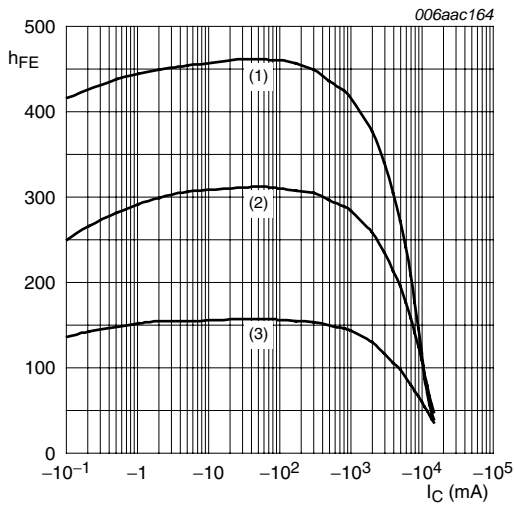

$V_{CE} = -2\text{ V}$   
 (1)  $T_{amb} = 100\text{ °C}$   
 (2)  $T_{amb} = 25\text{ °C}$   
 (3)  $T_{amb} = -55\text{ °C}$

**Fig 5. DC current gain as a function of collector current; typical values**

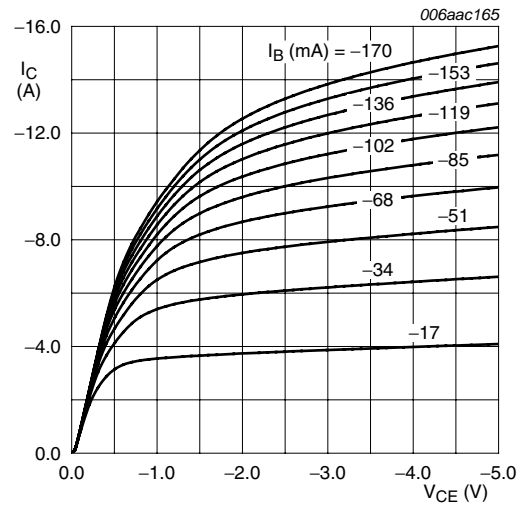

$T_{amb} = 25\text{ °C}$

**Fig 6. Collector current as a function of collector-emitter voltage; typical values**

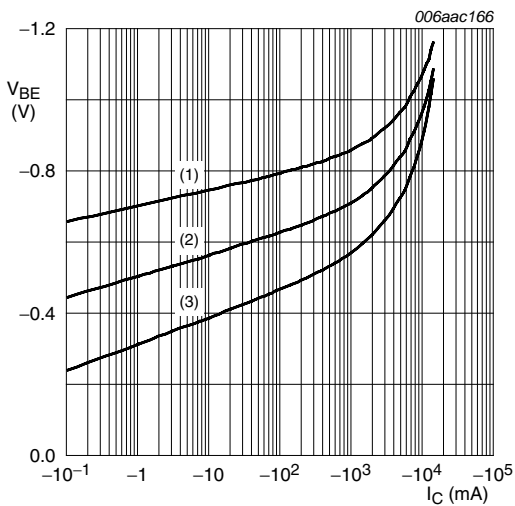

$V_{CE} = -2\text{ V}$   
 (1)  $T_{amb} = -55\text{ °C}$   
 (2)  $T_{amb} = 25\text{ °C}$   
 (3)  $T_{amb} = 100\text{ °C}$

**Fig 7. Base-emitter voltage as a function of collector current; typical values**

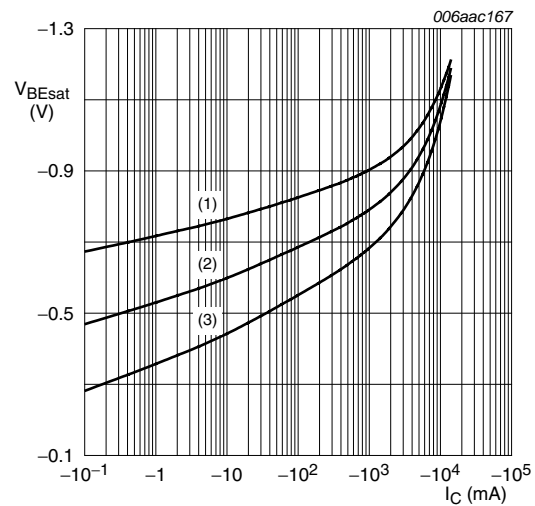

$I_C/I_B = 20$   
 (1)  $T_{amb} = -55\text{ °C}$   
 (2)  $T_{amb} = 25\text{ °C}$   
 (3)  $T_{amb} = 100\text{ °C}$

**Fig 8. Base-emitter saturation voltage as a function of collector current; typical values**

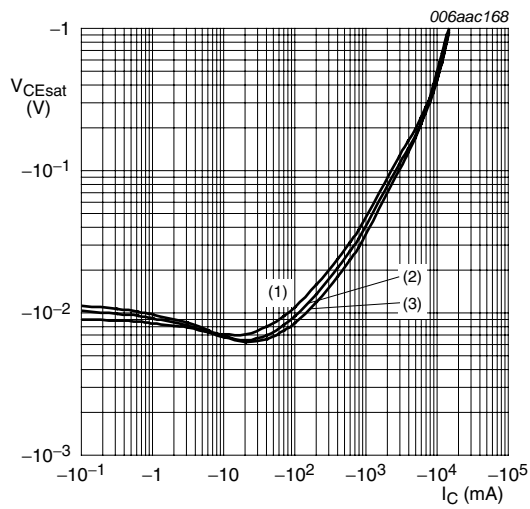

- $I_C/I_B = 20$
- (1)  $T_{amb} = 100\text{ °C}$
  - (2)  $T_{amb} = 25\text{ °C}$
  - (3)  $T_{amb} = -55\text{ °C}$

**Fig 9. Collector-emitter saturation voltage as a function of collector current; typical values**

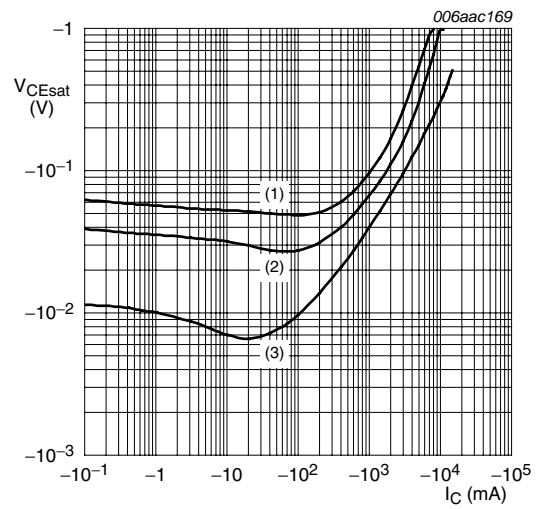

- $T_{amb} = 25\text{ °C}$
- (1)  $I_C/I_B = 100$
  - (2)  $I_C/I_B = 50$
  - (3)  $I_C/I_B = 10$

**Fig 10. Collector-emitter saturation voltage as a function of collector current; typical values**

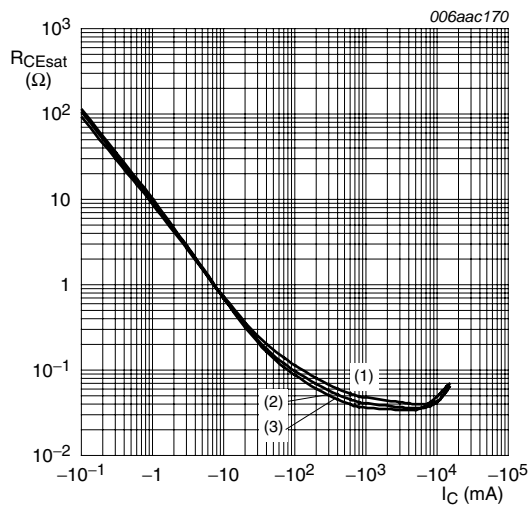

- $I_C/I_B = 20$
- (1)  $T_{amb} = 100\text{ °C}$
  - (2)  $T_{amb} = 25\text{ °C}$
  - (3)  $T_{amb} = -55\text{ °C}$

**Fig 11. Collector-emitter saturation resistance as a function of collector current; typical values**

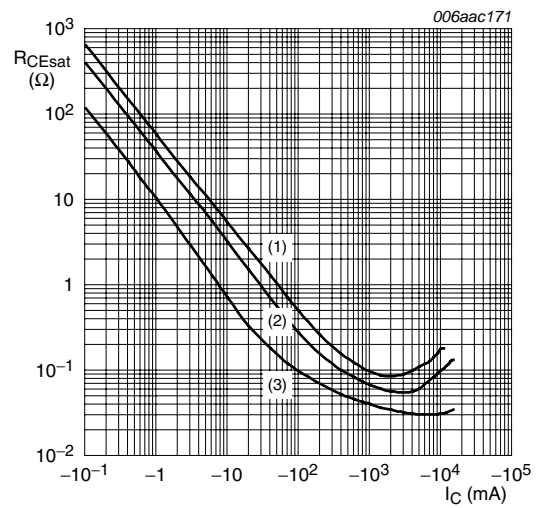

- $T_{amb} = 25\text{ °C}$
- (1)  $I_C/I_B = 100$
  - (2)  $I_C/I_B = 50$
  - (3)  $I_C/I_B = 10$

**Fig 12. Collector-emitter saturation resistance as a function of collector current; typical values**



## 8. Test information

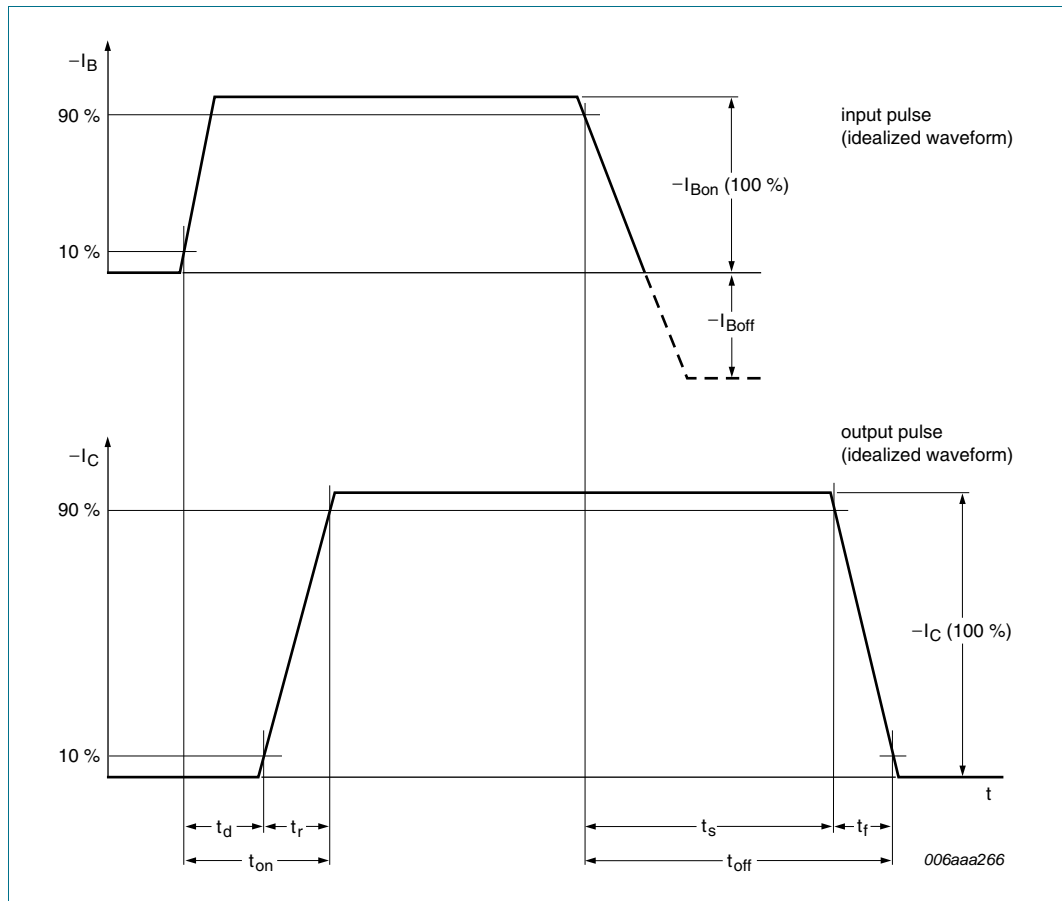

Fig 13. BISS transistor switching time definition

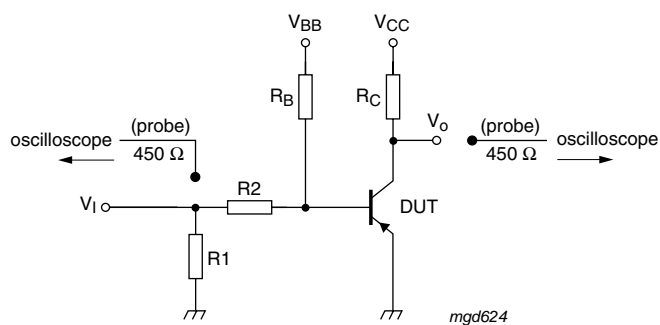
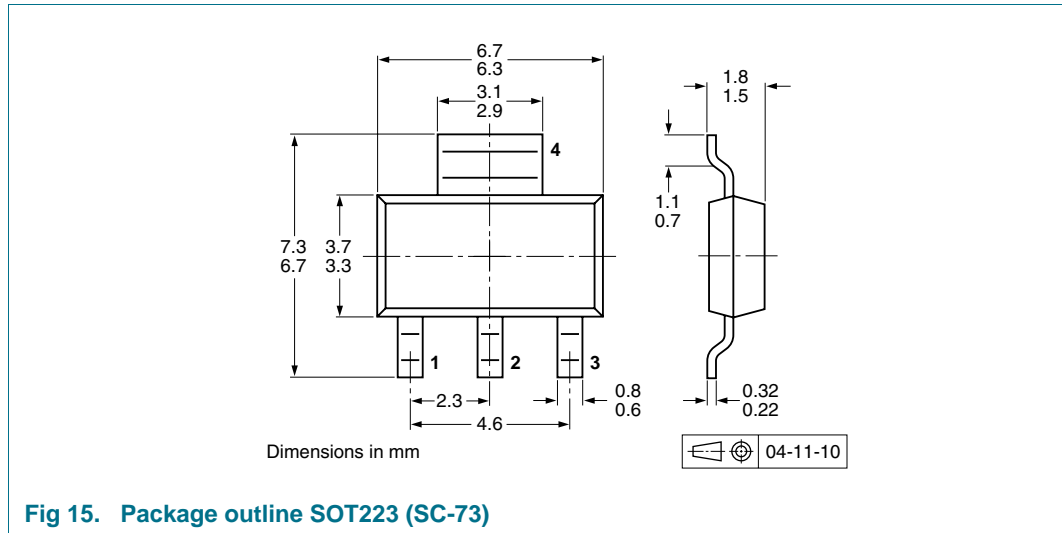

Fig 14. Test circuit for switching times

### 8.1 Quality information

This product has been qualified in accordance with the Automotive Electronics Council (AEC) standard Q101 - *Stress test qualification for discrete semiconductors*, and is suitable for use in automotive applications.

## 9. Package outline



## 10. Packing information

**Table 8. Packing methods**

The indicated -xxx are the last three digits of the 12NC ordering code.<sup>[1]</sup>

Type number	Package	Description	Packing quantity	
			1000	4000
PBSS4041PZ	SOT223	8 mm pitch, 12 mm tape and reel	-115	-135

[1] For further information and the availability of packing methods, see [Section 14](#).

**11. Soldering**

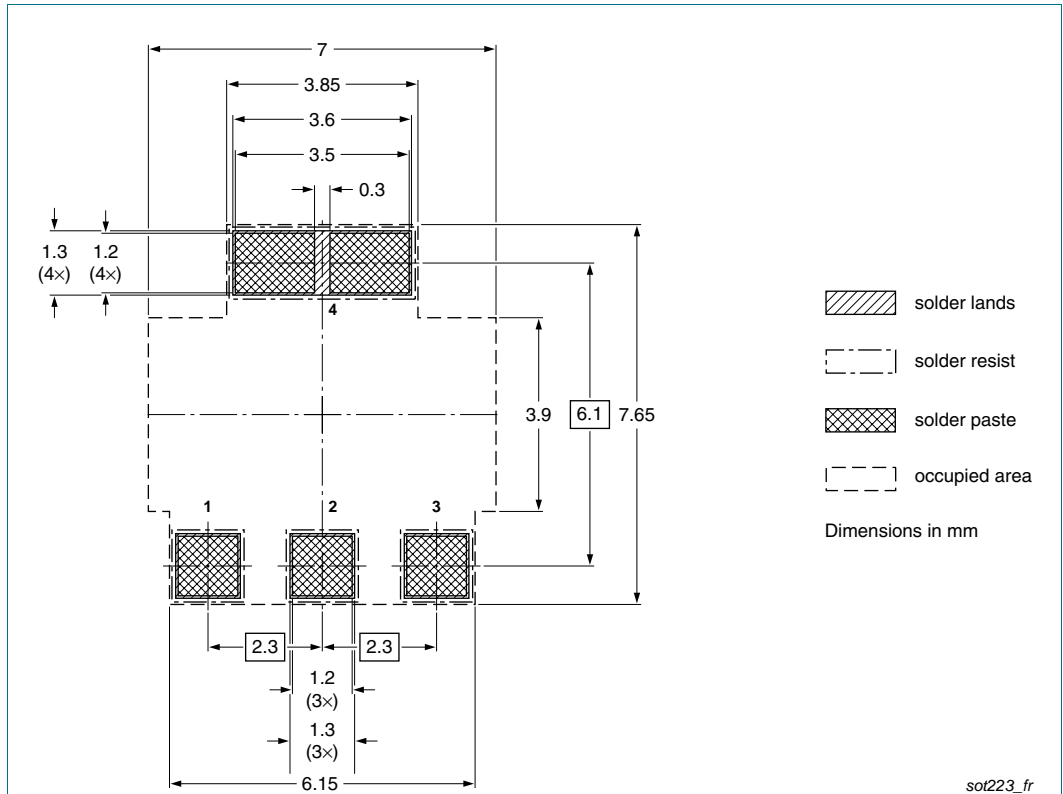

**Fig 16. Reflow soldering footprint SOT223 (SC-73)**

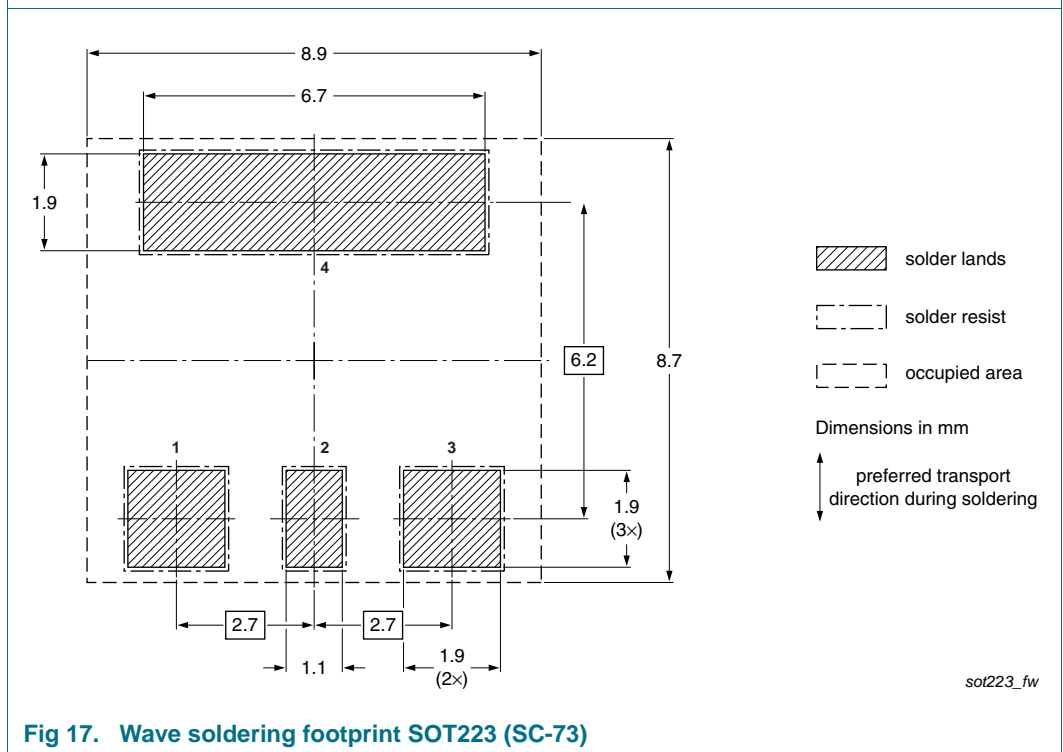

**Fig 17. Wave soldering footprint SOT223 (SC-73)**

## 12. Revision history

**Table 9.** Revision history

Document ID	Release date	Data sheet status	Change notice	Supersedes
PBSS4041PZ_1	20100331	Product data sheet	-	-

## 13. Legal information

### 13.1 Data sheet status

Document status <sup>[1][2]</sup>	Product status <sup>[3]</sup>	Definition
Objective [short] data sheet	Development	This document contains data from the objective specification for product development.
Preliminary [short] data sheet	Qualification	This document contains data from the preliminary specification.
Product [short] data sheet	Production	This document contains the product specification.

[1] Please consult the most recently issued document before initiating or completing a design.

[2] The term 'short data sheet' is explained in section "Definitions".

[3] The product status of device(s) described in this document may have changed since this document was published and may differ in case of multiple devices. The latest product status information is available on the Internet at URL <http://www.nxp.com>.

### 13.2 Definitions

**Draft** — The document is a draft version only. The content is still under internal review and subject to formal approval, which may result in modifications or additions. NXP Semiconductors does not give any representations or warranties as to the accuracy or completeness of information included herein and shall have no liability for the consequences of use of such information.

**Short data sheet** — A short data sheet is an extract from a full data sheet with the same product type number(s) and title. A short data sheet is intended for quick reference only and should not be relied upon to contain detailed and full information. For detailed and full information see the relevant full data sheet, which is available on request via the local NXP Semiconductors sales office. In case of any inconsistency or conflict with the short data sheet, the full data sheet shall prevail.

**Product specification** — The information and data provided in a Product data sheet shall define the specification of the product as agreed between NXP Semiconductors and its customer, unless NXP Semiconductors and customer have explicitly agreed otherwise in writing. In no event however, shall an agreement be valid in which the NXP Semiconductors product is deemed to offer functions and qualities beyond those described in the Product data sheet.

### 13.3 Disclaimers

**Limited warranty and liability** — Information in this document is believed to be accurate and reliable. However, NXP Semiconductors does not give any representations or warranties, expressed or implied, as to the accuracy or completeness of such information and shall have no liability for the consequences of use of such information.

In no event shall NXP Semiconductors be liable for any indirect, incidental, punitive, special or consequential damages (including - without limitation - lost profits, lost savings, business interruption, costs related to the removal or replacement of any products or rework charges) whether or not such damages are based on tort (including negligence), warranty, breach of contract or any other legal theory.

Notwithstanding any damages that customer might incur for any reason whatsoever, NXP Semiconductors' aggregate and cumulative liability towards customer for the products described herein shall be limited in accordance with the *Terms and conditions of commercial sale* of NXP Semiconductors.

**Right to make changes** — NXP Semiconductors reserves the right to make changes to information published in this document, including without limitation specifications and product descriptions, at any time and without notice. This document supersedes and replaces all information supplied prior to the publication hereof.

**Suitability for use** — NXP Semiconductors products are not designed, authorized or warranted to be suitable for use in medical, military, aircraft, space or life support equipment, nor in applications where failure or

malfunction of an NXP Semiconductors product can reasonably be expected to result in personal injury, death or severe property or environmental damage. NXP Semiconductors accepts no liability for inclusion and/or use of NXP Semiconductors products in such equipment or applications and therefore such inclusion and/or use is at the customer's own risk.

**Applications** — Applications that are described herein for any of these products are for illustrative purposes only. NXP Semiconductors makes no representation or warranty that such applications will be suitable for the specified use without further testing or modification.

NXP Semiconductors does not accept any liability related to any default, damage, costs or problem which is based on a weakness or default in the customer application/use or the application/use of customer's third party customer(s) (hereinafter both referred to as "Application"). It is customer's sole responsibility to check whether the NXP Semiconductors product is suitable and fit for the Application planned. Customer has to do all necessary testing for the Application in order to avoid a default of the Application and the product. NXP Semiconductors does not accept any liability in this respect.

**Limiting values** — Stress above one or more limiting values (as defined in the Absolute Maximum Ratings System of IEC 60134) will cause permanent damage to the device. Limiting values are stress ratings only and (proper) operation of the device at these or any other conditions above those given in the Recommended operating conditions section (if present) or the Characteristics sections of this document is not warranted. Constant or repeated exposure to limiting values will permanently and irreversibly affect the quality and reliability of the device.

**Terms and conditions of commercial sale** — NXP Semiconductors products are sold subject to the general terms and conditions of commercial sale, as published at <http://www.nxp.com/profile/terms>, unless otherwise agreed in a valid written individual agreement. In case an individual agreement is concluded only the terms and conditions of the respective agreement shall apply. NXP Semiconductors hereby expressly objects to applying the customer's general terms and conditions with regard to the purchase of NXP Semiconductors products by customer.

**No offer to sell or license** — Nothing in this document may be interpreted or construed as an offer to sell products that is open for acceptance or the grant, conveyance or implication of any license under any copyrights, patents or other industrial or intellectual property rights.

**Export control** — This document as well as the item(s) described herein may be subject to export control regulations. Export might require a prior authorization from national authorities.

**Quick reference data** — The Quick reference data is an extract of the product data given in the Limiting values and Characteristics sections of this document, and as such is not complete, exhaustive or legally binding.

### 13.4 Trademarks

Notice: All referenced brands, product names, service names and trademarks are the property of their respective owners.

## 14. Contact information

---

For more information, please visit: <http://www.nxp.com>

For sales office addresses, please send an email to: [salesaddresses@nxp.com](mailto:salesaddresses@nxp.com)

## 15. Contents

<b>1</b>	<b>Product profile</b> . . . . .	<b>1</b>
1.1	General description . . . . .	1
1.2	Features and benefits . . . . .	1
1.3	Applications . . . . .	1
1.4	Quick reference data . . . . .	1
<b>2</b>	<b>Pinning information</b> . . . . .	<b>2</b>
<b>3</b>	<b>Ordering information</b> . . . . .	<b>2</b>
<b>4</b>	<b>Marking</b> . . . . .	<b>2</b>
<b>5</b>	<b>Limiting values</b> . . . . .	<b>2</b>
<b>6</b>	<b>Thermal characteristics</b> . . . . .	<b>4</b>
<b>7</b>	<b>Characteristics</b> . . . . .	<b>6</b>
<b>8</b>	<b>Test information</b> . . . . .	<b>9</b>
8.1	Quality information . . . . .	9
<b>9</b>	<b>Package outline</b> . . . . .	<b>10</b>
<b>10</b>	<b>Packing information</b> . . . . .	<b>10</b>
<b>11</b>	<b>Soldering</b> . . . . .	<b>11</b>
<b>12</b>	<b>Revision history</b> . . . . .	<b>12</b>
<b>13</b>	<b>Legal information</b> . . . . .	<b>13</b>
13.1	Data sheet status . . . . .	13
13.2	Definitions . . . . .	13
13.3	Disclaimers . . . . .	13
13.4	Trademarks . . . . .	13
<b>14</b>	<b>Contact information</b> . . . . .	<b>14</b>
<b>15</b>	<b>Contents</b> . . . . .	<b>15</b>

Please be aware that important notices concerning this document and the product(s) described herein, have been included in section 'Legal information'.

© NXP B.V. 2010.

All rights reserved.

For more information, please visit: <http://www.nxp.com>

For sales office addresses, please send an email to: [salesaddresses@nxp.com](mailto:salesaddresses@nxp.com)

Date of release: 31 March 2010

Document identifier: PBSS4041PZ\_1