

**PC-18T1 • PC-18T2 • PC-18T4**

These Photocouplers consist of a Gallium Arsenide Infrared Emitting Diode and a Silicon NPN Photo Darlington transistor per channel.

The PC-18T1 has one channel in a 4-pin package.

The PC-18T2 has two channels in a 8-pin package.

The PC-18T4 has four channels in a 16-pin package.

**FEATURES**

- Small Package Size
- Collector-Emitter Voltage : Min.30V
- Current Transfer Ratio : Type 1000% (at  $I_F=1mA$ ,  $V_{CE}=2V$ )
- Electrical Isolation Voltage : AC2500V<sub>rms</sub>
- UL Recognized File No. E107486

**APPLICATIONS**

- Interface between two circuits of different potential
- Telephone Line Receiver
- Automatic Vending Machine
- Power Supply Regulators

**DIMENSION**

(Unit : mm)

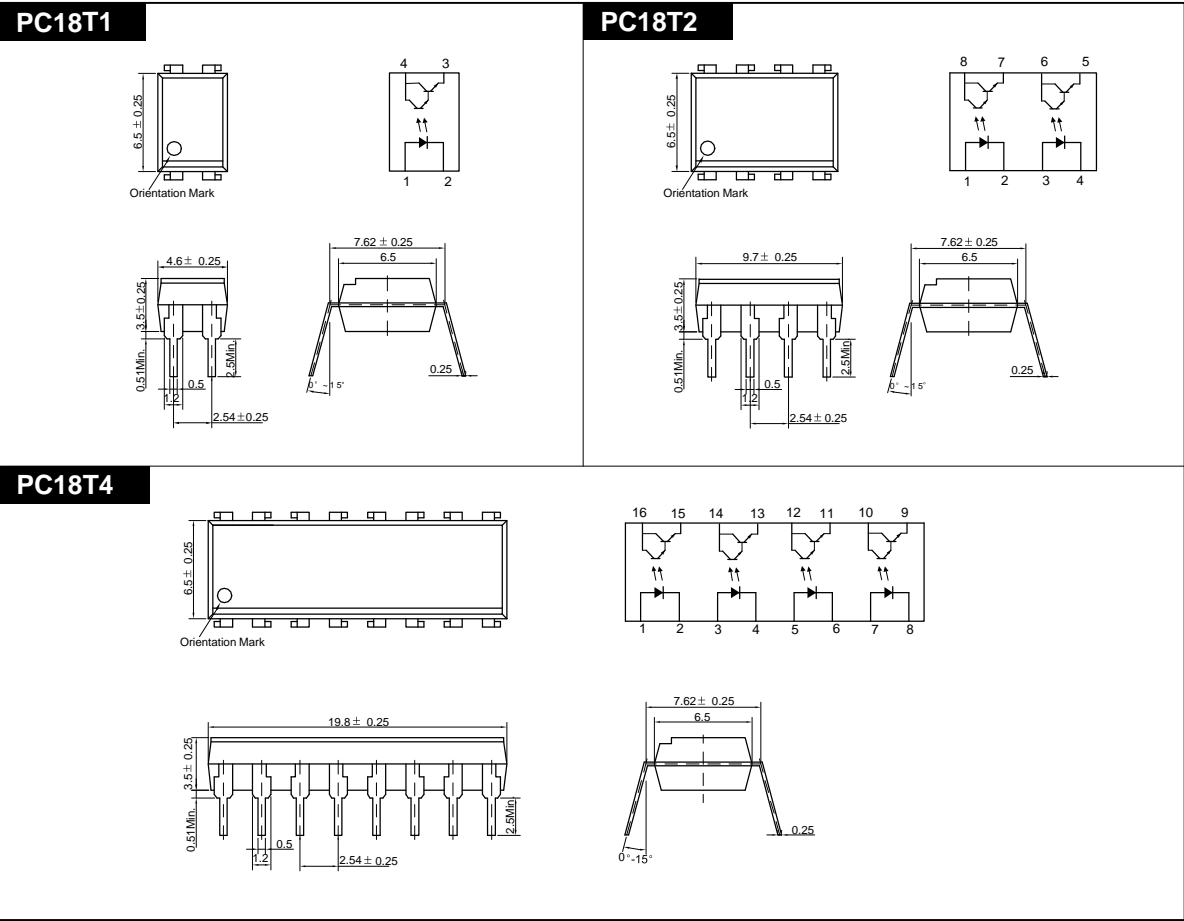

## PC-18T1 • PC-18T2 • PC-18T4

### MAXIMUM RATINGS

(Ta=25 )

Parameter		Symbol	Rating	Unit
Input	Forward Current	IF	60	mA
	Reverse Voltage	VR	5	V
	Peak Forward Current <sup>*1</sup>	IFP	1	A
	Power Dissipation	PD	150	mW
	Junction Temperature	TJ	125	
Output	Collector-Emitter Breakdown Voltage	BVCEO	30	V
	Emitter-Collector Breakdown Voltage	BVECO	5	V
	Collector Current	IC	50	mA
	Collector Power Dissipation	PC	150	mW
Input to Output Isolation Voltage <sup>*2</sup>		Viso	AC2500	V <sub>rms</sub>
Storage Temperature		T <sub>stg</sub>	-55~+125	
Operating Temperature		T <sub>opr</sub>	-30~+100	
Lead Soldering Temperature <sup>*3</sup>		T <sub>sol</sub>	260	
Total Power Dissipation		P <sub>tot</sub>	250	mW

\*1. Input current with 100μs pulse width, 1% duty cycle

\*2. Measured at RH=40~60% for 1min

\*3. 1/16 inch form case for 10sec

### ELECTRO-OPTICAL CHARACTERISTICS

(Ta=25 , unless otherwise noted)

Parameter		Symbol	Condition	Min.	Typ.	Max.	Unit.
Input	Forward Voltage	VF	IF=10mA	-	1.15	1.30	V
	Reverse Current	IR	VR=5V	-	-	10	μA
	Capacitance	CT	V=0, f=1kHz	-	30	-	pF
Output	Collector-Emitter Breakdown Voltage	BVCEO	IC=0.5mA	30	-	-	V
	Emitter-Collector Breakdown Voltage	BVECO	IE=0.1mA	5	-	-	V
	Collector Dark Current	ICEO	IF=0, VCE=10V	-	-	100	nA
	Capacitance	CCE	VCE=0, f=1kHz	-	10	-	pF
Coupled	Current Transfer Ratio <sup>*4</sup>	CTR	IF=1mA, VCE=2V	300	-	600	%
	Collector-Emitter Saturation Voltage	VCE(SAT)	IF=1mA, IC=2mA	-	0.85	1.0	V
	Input-Output Capacitance	CIO	V=0, f=1kHz	-	1	-	pF
	Input-Output Isolation Resistance	RIO	RH=40~60%, V=500V	-	10 <sup>11</sup>	-	
	Rise Time	tr	VCE=10V, RL=100	-	100	-	μs
	Fall Time	tf	IC=10mA	-	100	-	μs

\*4. CTR=(IC/IF) X 100 (%)

PC-18T1 • PC-18T2 • PC-18T4

Forward Current vs. Ambient Temperature

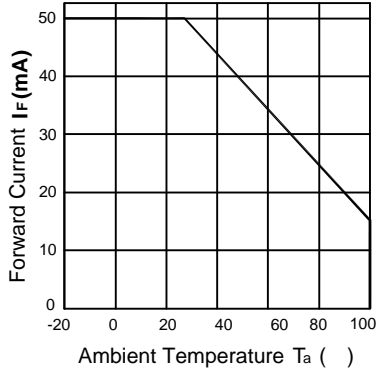

Collector Power Dissipation vs. Ambient Temperature

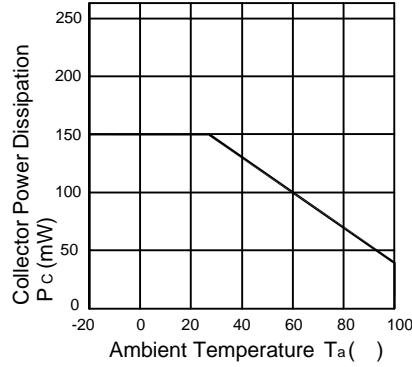

Forward Current vs. Forward Voltage

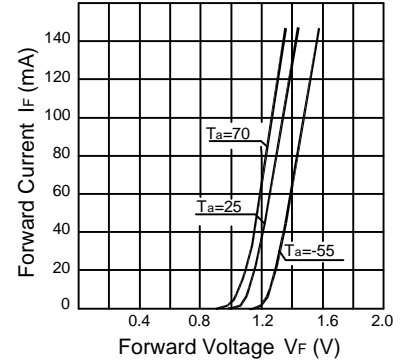

Collector Current vs. Collector-Emitter Voltage

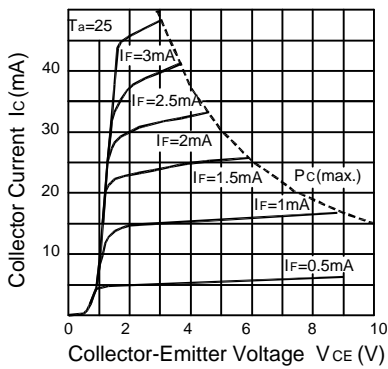

Dark Current vs. Ambient Temperature

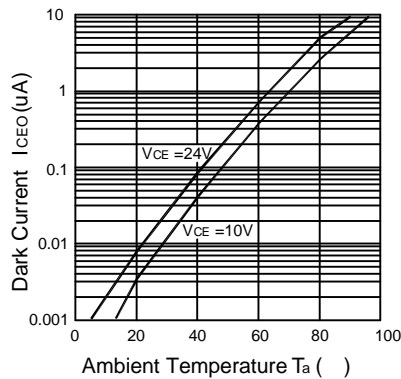

Collector Current vs. Forward Current

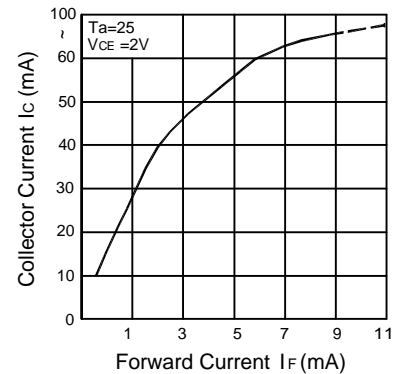

Response Time vs. Load Resistance

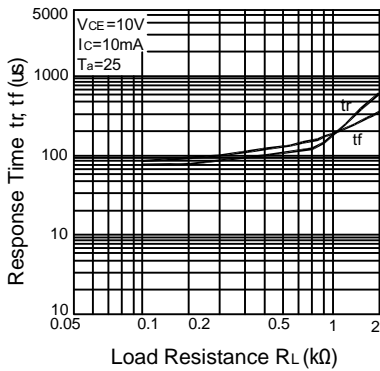

Switching Time Test Circuit

