

8-BIT SYNCHRONOUS BCD DOWN COUNTER

FEATURES

- Cascadable
- Synchronous or asynchronous preset
- Output capability: standard
- I_{CC} category: MSI

GENERAL DESCRIPTION

The 74HC/HCT40102 are high-speed Si-gate CMOS devices and are pin compatible with the "40102" of the "4000B" series. They are specified in compliance with JEDEC standard no. 7A.

The 74HC/HCT40102 consist each of an 8-bit synchronous down counter with a single output which is active when the internal count is zero. The "40102" is configured as two cascaded 4-bit BCD counters and has control inputs for enabling or disabling the clock (CP), for clearing the counter to its maximum count, and for presetting the counter either synchronously or asynchronously. All control inputs and the terminal count output (TC) are active-LOW logic.

In normal operation, the counter is decremented by one count on each positive-going transition of the clock (CP). Counting is inhibited when the terminal enable input (TE) is HIGH. The terminal count output (TC) goes LOW when the count reaches zero if TE is LOW, and remains LOW for one full clock period.

When the synchronous preset enable input (PE) is LOW, data at the jam input (P₀ to P₇) is clocked into the counter on the next positive-going clock transition regardless of the state of TE.

When the asynchronous preset enable input (PL) is LOW, data at the jam input (P₀ to P₇) is asynchronously forced into the counter regardless of the state of PE, TE, or CP. The jam inputs (P₀ to P₇) represent two 4-bit BCD words.

(continued on next page)

SYMBOL	PARAMETER	CONDITIONS	TYPICAL		UNIT
			HC	HCT	
t _{PHL} / t _{PLH}	propagation delay CP to TC	C _L = 15 pF V _{CC} = 5 V	30	31	ns
f _{max}	maximum clock frequency		30	30	MHz
C _I	input capacitance		3.5	3.5	pF
C _{PD}	power dissipation capacitance per package	notes 1 and 2	20	25	pF

GND = 0 V; T_{amb} = 25 °C; t_r = t_f = 6 ns

Notes

1. C_{PD} is used to determine the dynamic power dissipation (P_D in μW):

$$P_D = C_{PD} \times V_{CC}^2 \times f_i + \sum (C_L \times V_{CC}^2 \times f_o) \text{ where:}$$

f_i = input frequency in MHz C_L = output load capacitance in pF
f_o = output frequency in MHz V_{CC} = supply voltage in V
Σ (C_L × V_{CC}² × f_o) = sum of outputs

2. For HC the condition is V_I = GND to V_{CC}
For HCT the condition is V_I = GND to V_{CC} - 1.5 V

PACKAGE OUTLINES

16-lead DIL; plastic (SOT38Z).

16-lead mini-pack; plastic (SO16; SOT109A).

PIN DESCRIPTION

PIN NO.	SYMBOL	NAME AND FUNCTION
1	CP	clock input (LOW-to-HIGH, edge-triggered)
2	MR	asynchronous master reset input (active LOW)
3	TE	terminal enable input
4, 5, 6, 7, 10, 11, 12, 13	P ₀ to P ₇	jam inputs
8	GND	ground (0 V)
9	PL	asynchronous preset enable input (active LOW)
14	TC	terminal count output (active LOW)
15	PE	synchronous preset enable input (active LOW)
16	V _{CC}	positive supply voltage

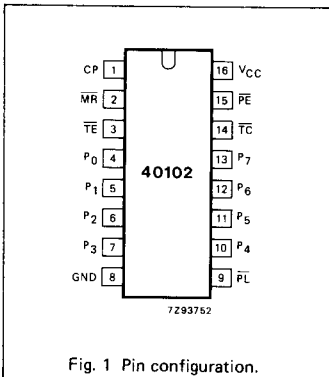

Fig. 1 Pin configuration.

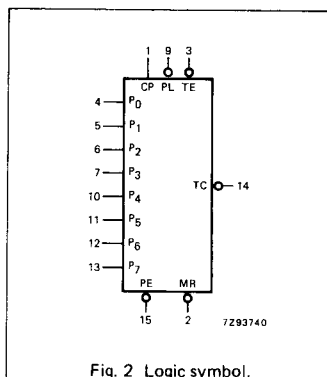

Fig. 2 Logic symbol.

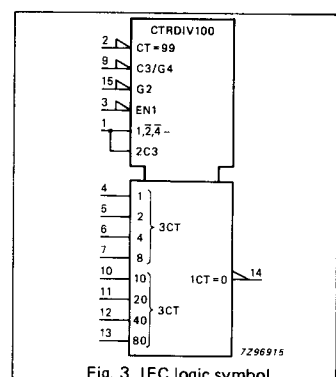

Fig. 3 IEC logic symbol.

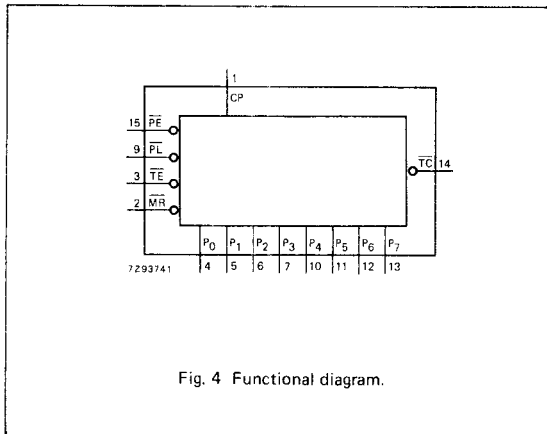

Fig. 4 Functional diagram.

GENERAL DESCRIPTION

When the master reset input (\overline{MR}) is LOW, the counter is asynchronously cleared to its maximum count (decimal 99) regardless of the state of any other input. The precedence relationship between control inputs is indicated in the function table.

If all control inputs except \overline{TE} are HIGH at the time of zero count, the counters will jump to the maximum count, giving a counting sequence of 100 clock pulses long.

The "40102" may be cascaded using the \overline{TE} input and the \overline{TC} output, in either a synchronous or ripple mode.

APPLICATIONS

- Divide-by-n counters
- Programmable timers
- Interrupt timers
- Cycle/program counters

FUNCTION TABLE

CONTROL INPUTS				PRESET MODE	ACTION
\overline{MR}	\overline{PL}	\overline{PE}	\overline{TE}		
H	H	H	H	synchronous	inhibit counter
H	H	H	L		count down
H	H	L	X		preset on next LOW-to-HIGH clock transition
H	L	X	X	asynchronous	preset asynchronously
L	X	X	X		clear to maximum count

Notes to function table

1. Clock connected to CP.
2. Synchronous operation: changes occur on the LOW-to-HIGH CP transition.
3. Jam inputs: MSD = P₇, LSD = P₀.

H = HIGH voltage level
 L = LOW voltage level
 X = don't care

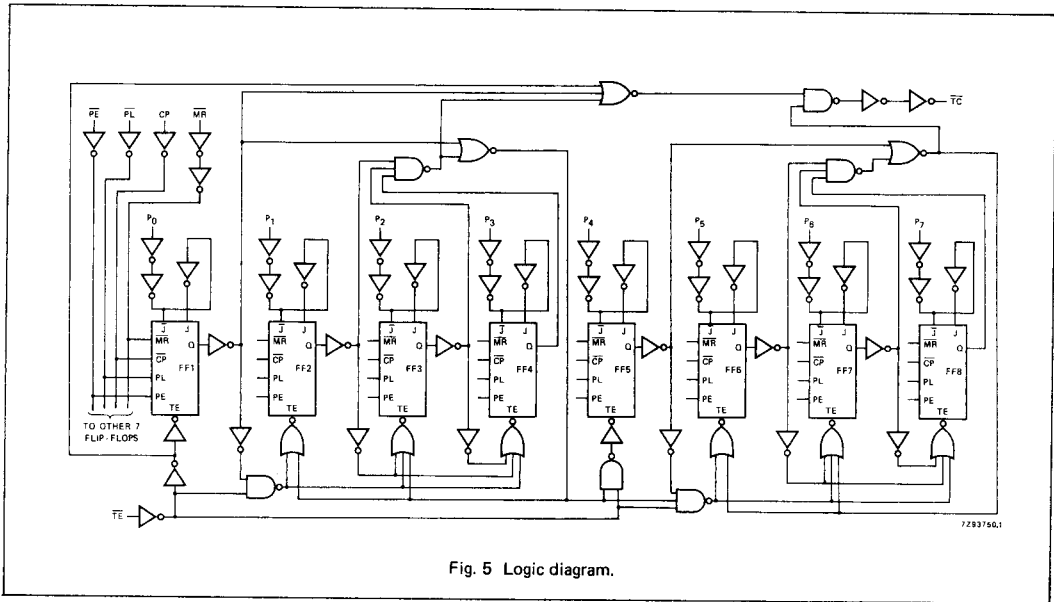

Fig. 5 Logic diagram.

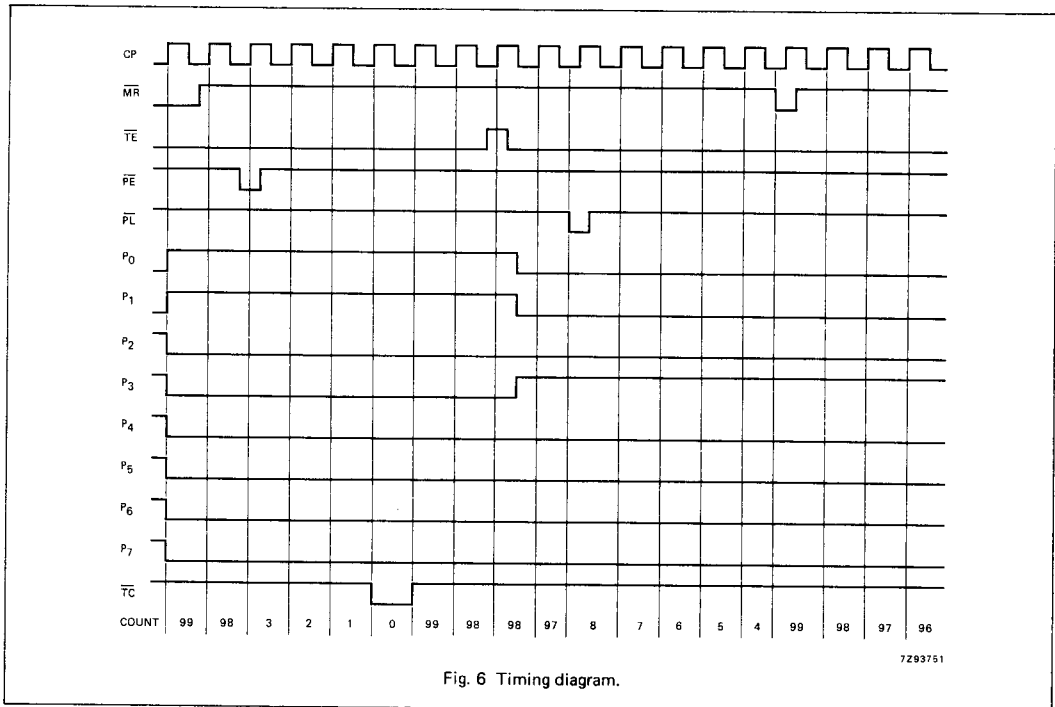

Fig. 6 Timing diagram.

DC CHARACTERISTICS FOR 74HC

For the DC characteristics see chapter "HCMOS family characteristics", section "Family specifications".

Output capability: standard

I_{CC} category: MSI

AC CHARACTERISTICS FOR 74HC

GND = 0 V; t_r = t_f = 6 ns; C_L = 50 pF

SYMBOL	PARAMETER	T _{amb} (°C)						UNIT	TEST CONDITIONS		
		74HC							V _{CC} V	WAVEFORMS	
		+25			-40 to +85		-40 to +125				
		min.	typ.	max.	min.	max.	min.		max.		
t _{PHL} / t _{PLH}	propagation delay CP to \overline{TC}		96 35 28	300 60 51		375 75 64		450 90 77	ns	2.0 4.5 6.0	Fig. 7
t _{PHL} / t _{PLH}	propagation delay TE to \overline{TC}		50 18 14	200 40 34		250 50 43		300 60 51	ns	2.0 4.5 6.0	Fig. 8
t _{PHL} / t _{PLH}	propagation delay P _n , PL to \overline{TC}		110 40 32	240 68 58		425 85 72		510 102 87	ns	2.0 4.5 6.0	Fig. 9
t _{PLH}	propagation delay MR to TC		83 30 24	275 55 47		345 69 59		415 83 71	ns	2.0 4.5 6.0	Fig. 9
t _{THL} / t _{TLH}	output transition time		9 7 6	75 15 13		95 19 16		110 22 19	ns	2.0 4.5 6.0	Figs 7 and 8
t _W	clock pulse width HIGH or LOW	165 33 28	22 8 6		205 41 35		250 50 43		ns	2.0 4.5 6.0	Fig. 7
t _W	master reset pulse width LOW	150 30 26	30 11 9		190 38 33		225 45 38		ns	2.0 4.5 6.0	Fig. 9
t _W	preset enable pulse width PL; LOW	125 25 21	39 14 11		155 31 26		190 38 32		ns	2.0 4.5 6.0	Fig. 9
t _{rem}	removal time PL; MR to CP	50 10 9	8 3 2		65 13 11		75 15 13		ns	2.0 4.5 6.0	Fig. 10
t _{su}	set-up time PE to CP	100 20 17	36 13 10		125 25 21		150 30 26		ns	2.0 4.5 6.0	Fig. 11
t _{su}	set-up time TE to CP	175 35 30	50 18 14		220 44 37		265 53 45		ns	2.0 4.5 6.0	Fig. 11
t _{su}	set-up time P _n to CP	100 20 17	33 12 10		125 25 21		150 30 26		ns	2.0 4.5 6.0	Fig. 12

AC CHARACTERISTICS FOR 74HC (Cont'd)

GND = 0 V; $t_r = t_f = 6$ ns; $C_L = 50$ pF

SYMBOL	PARAMETER	T_{amb} (°C)						UNIT	TEST CONDITIONS		
		74HC							V_{CC} V	WAVEFORMS	
		+25			-40 to +85		-40 to +125				
		min.	typ.	max.	min.	max.	min.				max.
t_h	hold time \overline{PE} to CP	2 2 2	-8 -3 -2		2 2 2		2 2 2		ns	2.0 4.5 6.0	Fig. 11
t_h	hold time TE to CP	0 0 0	-41 -15 -12		0 0 0		0 0 0		ns	2.0 4.5 6.0	Fig. 11
t_h	hold time P_n to CP	2 2 2	-5 -5 -5		2 2 2		2 2 2		ns	2.0 4.5 6.0	Fig. 12
f_{max}	maximum clock pulse frequency	3 15 18	8.9 27 32		2 12 14		2 10 12		MHz	2.0 4.5 6.0	Fig. 7

DC CHARACTERISTICS FOR 74HC

For the DC characteristics see chapter "HCMOS family characteristics", section "Family specifications".

Output capability: standard

 I_{CC} category: MSI

Note to HCT types

The value of additional quiescent supply current (ΔI_{CC}) for a unit load of 1 is given in the family specifications. To determine ΔI_{CC} per input, multiply this value by the unit load coefficient shown in the table below.

INPUT	UNIT LOAD COEFFICIENT
CP, \overline{PE}	1.50
\overline{MR}	1.00
TE	0.80
P_n	0.25
\overline{PL}	0.35

AC CHARACTERISTICS FOR 74HCT

GND = 0 V; $t_r = t_f = 6$ ns; $C_L = 50$ pF

SYMBOL	PARAMETER	T_{amb} (°C)						UNIT	TEST CONDITIONS		
		74HCT							V_{CC} V	WAVEFORMS	
		+25			-40 to +85		-40 to +125				
		min.	typ.	max.	min.	max.	min.				max.
t_{PHL}/t_{PLH}	propagation delay P_n ; CP to \overline{TC}		38	63		79		95	ns	4.5	Figs 7 and 9
t_{PHL}/t_{PLH}	propagation delay \overline{TE} to \overline{TC}		25	50		63		75	ns	4.5	Fig. 8
t_{PHL}/t_{PLH}	propagation delay PL to \overline{TC}		49	83		104		125	ns	4.5	Fig. 9
t_{PLH}	propagation delay MR to \overline{TC}		31	55		69		83	ns	4.5	Fig. 9
t_{THL}/t_{TLH}	output transition time		7	15		19		22	ns	4.5	Figs 7 and 8
t_W	clock pulse width HIGH or LOW	33	11		41		50		ns	4.5	Fig. 7
t_W	master reset pulse width LOW	30	16		38		45		ns	4.5	Fig. 9
t_W	preset enable pulse width PL; LOW	43	25		54		65		ns	4.5	Fig. 9
t_{rem}	removal time PL; MR to CP	10	1		13		15		ns	4.5	Fig. 10
t_{su}	set-up time \overline{PE} to CP	20	10		25		30		ns	4.5	Fig. 11
t_{su}	set-up time \overline{TE} to CP	40	20		50		60		ns	4.5	Fig. 11
t_{su}	set-up time P_n to CP	20	12		25		30		ns	4.5	Fig. 12
t_h	hold time \overline{PE} to CP	0	-4		0		0		ns	4.5	Fig. 11
t_h	hold time \overline{TE} to CP	0	-15		0		0		ns	4.5	Fig. 11
t_h	hold time P_n to CP	0	-6		0		0		ns	4.5	Fig. 12
f_{max}	maximum clock pulse frequency	15	27		12		10		MHz	4.5	Fig. 7

AC WAVEFORMS

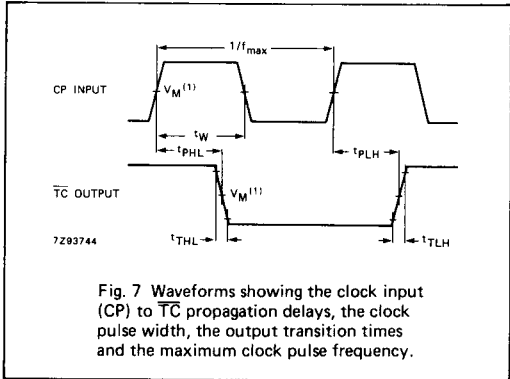

Fig. 7 Waveforms showing the clock input (CP) to \overline{TC} propagation delays, the clock pulse width, the output pulse width and the maximum clock pulse frequency.

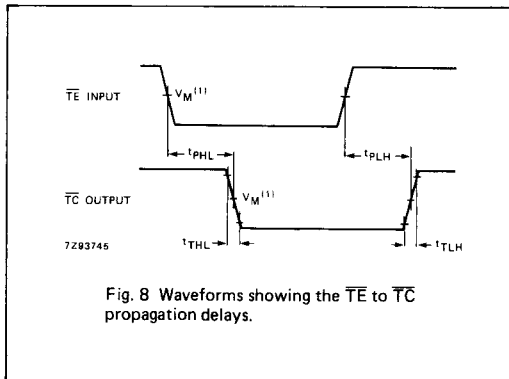

Fig. 8 Waveforms showing the \overline{TE} to \overline{TC} propagation delays.

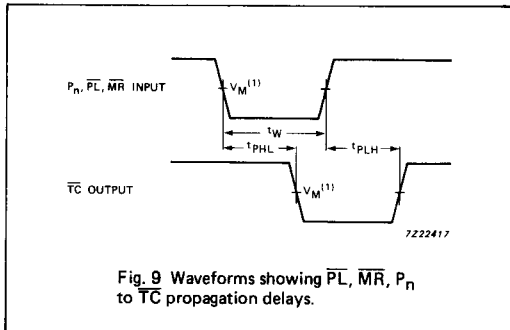

Fig. 9 Waveforms showing \overline{PL} , \overline{MR} , P_n to \overline{TC} propagation delays.

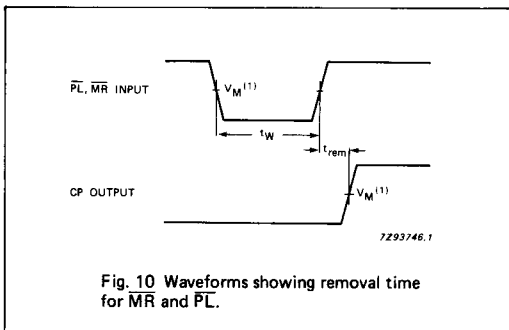

Fig. 10 Waveforms showing removal time for \overline{MR} and \overline{PL} .

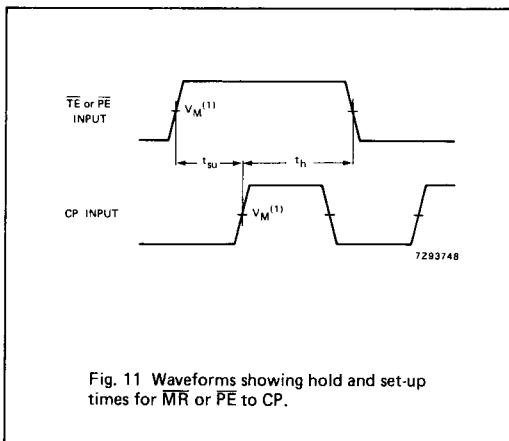

Fig. 11 Waveforms showing hold and set-up times for \overline{MR} or \overline{PE} to CP.

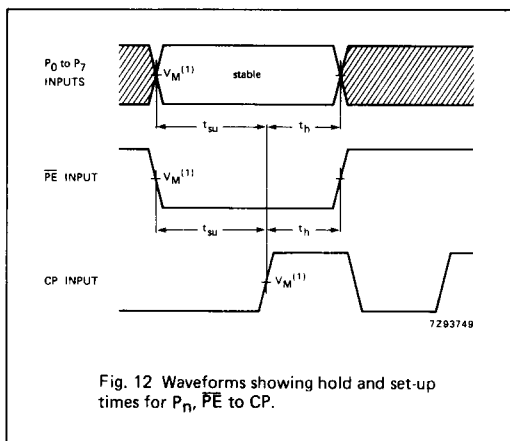

Fig. 12 Waveforms showing hold and set-up times for P_n , \overline{PE} to CP.

Note to AC waveforms

(1) HC : $V_M = 50\%$; $V_I = GND$ to V_{CC} .
 HCT: $V_M = 1.3V$; $V_I = GND$ to $3V$.

Note to Fig. 12

The shaded areas indicate when the input is permitted to change for predictable output performance.

APPLICATION INFORMATION

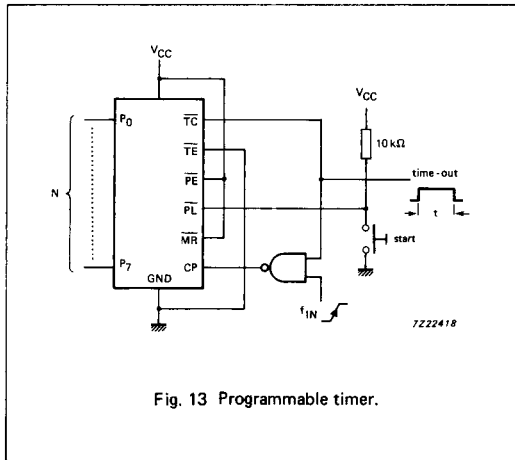

Fig. 13 Programmable timer.

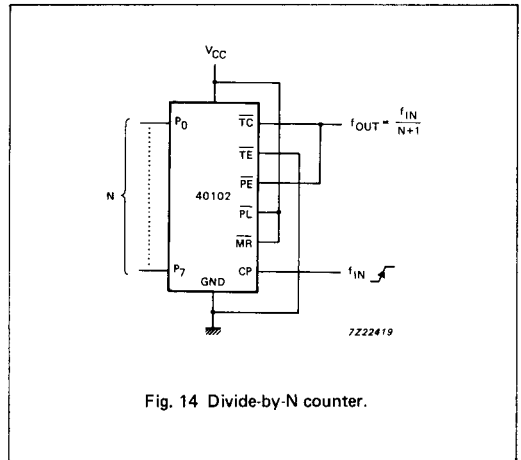

Fig. 14 Divide-by-N counter.