

## 8-BIT SYNCHRONOUS BINARY DOWN COUNTER

### FEATURES

- Cascadable
- Synchronous or asynchronous preset
- Output capability: standard
- I<sub>CC</sub> category: MSI

### GENERAL DESCRIPTION

The 74HC/HCT40103 are high-speed Si-gate CMOS devices and are pin compatible with the "40103" of the "4000B" series. They are specified in compliance with JEDEC standard no. 7A.

The 74HC/HCT40103 consist each of an 8-bit synchronous down counter with a single output which is active when the internal count is zero. The "40103" contains a single 8-bit binary counter and has control inputs for enabling or disabling the clock (CP), for clearing the counter to its maximum count, and for presetting the counter either synchronously or asynchronously. All control inputs and the terminal count output (TC) are active-LOW logic.

In normal operation, the counter is decremented by one count on each positive-going transition of the clock (CP). Counting is inhibited when the terminal enable input (TE) is HIGH. The terminal count output (TC) goes LOW when the count reaches zero if TE is LOW, and remains LOW for one full clock period.

When the synchronous preset enable input (PE) is LOW, data at the jam input (P<sub>0</sub> to P<sub>7</sub>) is clocked into the counter on the next positive-going clock transition regardless of the state of TE.

When the asynchronous preset enable input (PL) is LOW, data at the jam input (P<sub>0</sub> to P<sub>7</sub>) is asynchronously forced into the counter regardless of the state of PE, TE, or CP. The jam inputs (P<sub>0</sub> to P<sub>7</sub>) represent a single 8-bit binary word.

(continued on next page)

SYMBOL	PARAMETER	CONDITIONS	TYPICAL		UNIT
			HC	HCT	
t <sub>PHL</sub> / t <sub>PLH</sub>	propagation delay CP to TC	C <sub>L</sub> = 15 pF V <sub>CC</sub> = 5 V	30	30	ns
f <sub>max</sub>	maximum clock frequency		32	31	MHz
C <sub>I</sub>	input capacitance		3.5	3.5	pF
C <sub>PD</sub>	power dissipation capacitance per package	notes 1 and 2	24	27	pF

GND = 0 V; T<sub>amb</sub> = 25 °C; t<sub>r</sub> = t<sub>f</sub> = 6 ns

### Notes

1. C<sub>PD</sub> is used to determine the dynamic power dissipation (P<sub>D</sub> in μW):

$$P_D = C_{PD} \times V_{CC}^2 \times f_i + \sum (C_L \times V_{CC}^2 \times f_o) \text{ where:}$$

f<sub>i</sub> = input frequency in MHz  
f<sub>o</sub> = output frequency in MHz  
Σ (C<sub>L</sub> × V<sub>CC</sub><sup>2</sup> × f<sub>o</sub>) = sum of outputs  
C<sub>L</sub> = output load capacitance in pF  
V<sub>CC</sub> = supply voltage in V

2. For HC the condition is V<sub>I</sub> = GND to V<sub>CC</sub>  
For HCT the condition is V<sub>I</sub> = GND to V<sub>CC</sub> - 1.5 V

### PACKAGE OUTLINES

16-lead DIL; plastic (SOT38Z).

16-lead mini-pack; plastic (SO16; SOT109A).

### PIN DESCRIPTION

PIN NO.	SYMBOL	NAME AND FUNCTION
1	CP	clock input (LOW-to-HIGH, edge-triggered)
2	MR	asynchronous master reset input (active LOW)
3	TE	terminal enable input
4, 5, 6, 7, 10, 11, 12, 13	P <sub>0</sub> to P <sub>7</sub>	jam inputs
8	GND	ground (0 V)
9	PL	asynchronous preset enable input (active LOW)
14	TC	terminal count output (active LOW)
15	PE	synchronous preset enable input (active LOW)
16	V <sub>CC</sub>	positive supply voltage

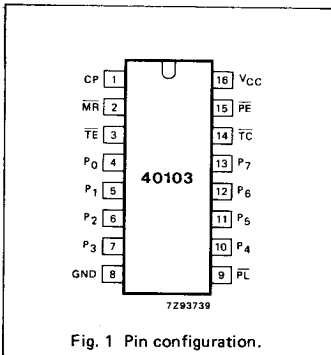

Fig. 1 Pin configuration.

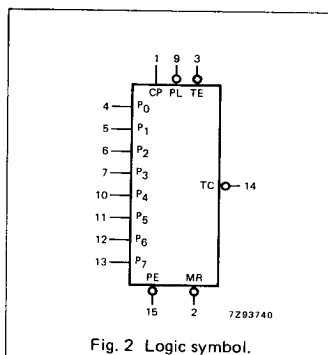

Fig. 2 Logic symbol.

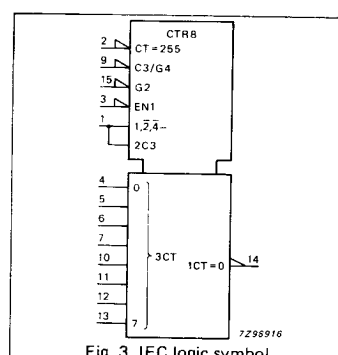

Fig. 3 IEC logic symbol.

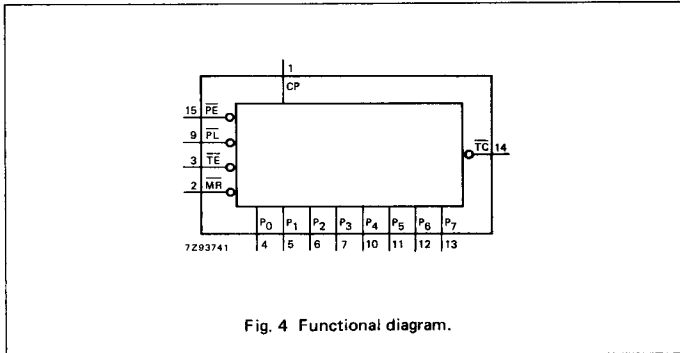

Fig. 4 Functional diagram.

**GENERAL DESCRIPTION (Cont'd)**

When the master reset input ( $\overline{MR}$ ) is LOW, the counter is asynchronously cleared to its maximum count (decimal 255) regardless of the state of any other input. The precedence relationship between control inputs is indicated in the function table.

If all control inputs except  $\overline{TE}$  are HIGH at the time of zero count, the counters will jump to the maximum count, giving a counting sequence of 256 clock pulses long. The "40103" may be cascaded using the  $\overline{TE}$  input and the TC output, in either a synchronous or ripple mode.

**APPLICATIONS**

- Divide-by-n counters
- Programmable timers
- Interrupt timers
- Cycle/program counters

**FUNCTION TABLE**

CONTROL INPUTS				PRESET MODE	ACTION
MR	PL	PE	TE		
H	H	H	H	synchronous	inhibit counter
H	H	H	L		count down
H	H	L	X		preset on next LOW-to-HIGH clock transition
H	L	X	X	asynchronous	preset asynchronously
L	X	X	X		clear to maximum count

**Notes to function table**

1. Clock connected to CP.
2. Synchronous operation: changes occur on the LOW-to-HIGH CP transition.
3. Jam inputs: MSD = P<sub>7</sub>, LSD = P<sub>0</sub>.

H = HIGH voltage level  
L = LOW voltage level  
X = don't care

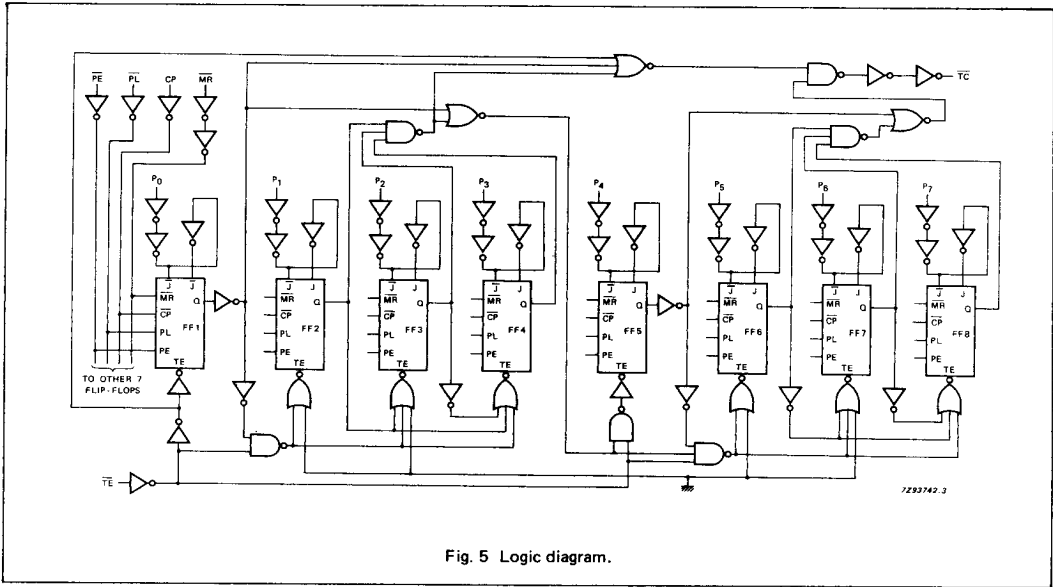

Fig. 5 Logic diagram.

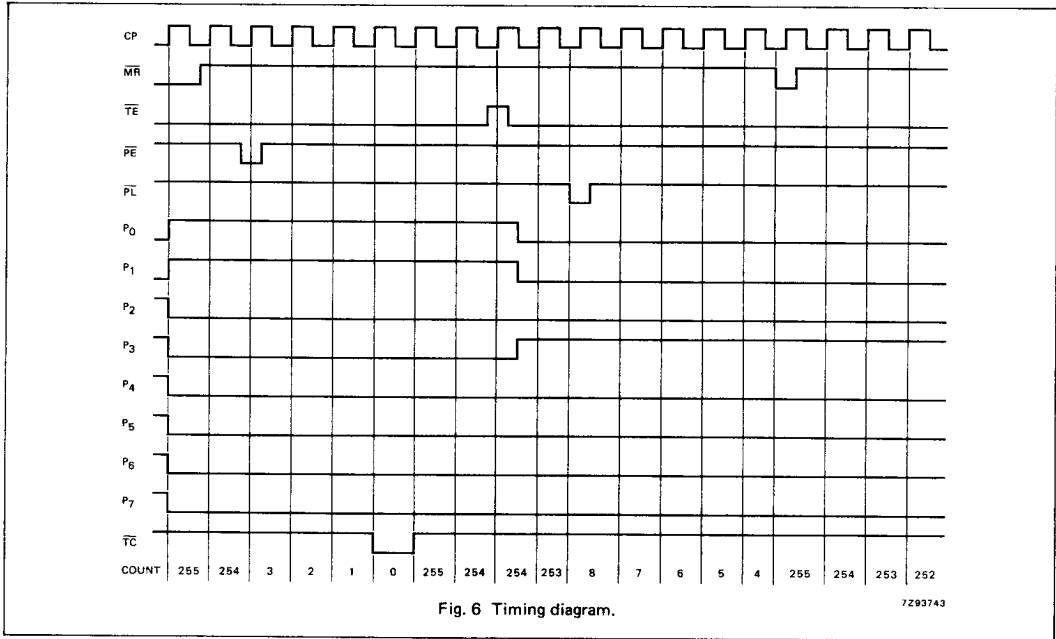

Fig. 6 Timing diagram.

## DC CHARACTERISTICS FOR 74HC

For the DC characteristics see chapter "HCMOS family characteristics", section "Family specifications".

Output capability: standard

I<sub>CC</sub> category: MSI

## AC CHARACTERISTICS FOR 74HC

GND = 0 V; t<sub>r</sub> = t<sub>f</sub> = 6 ns; C<sub>L</sub> = 50 pF

SYMBOL	PARAMETER	Tamb (°C)						UNIT	TEST CONDITIONS		
		74HC							V <sub>CC</sub> V	WAVEFORMS	
		+25			-40 to +85		-40 to +125				
		min.	typ.	max.	min.	max.	min.				max.
t <sub>PHL</sub> / t <sub>PLH</sub>	propagation delay CP to TC		96 35 28	300 60 51		375 75 64		450 90 77	ns	2.0 4.5 6.0	Fig. 7
t <sub>PHL</sub> / t <sub>PLH</sub>	propagation delay TE to TC		50 18 14	175 35 30		220 44 37		265 53 45	ns	2.0 4.5 6.0	Fig. 8
t <sub>PHL</sub> / t <sub>PLH</sub>	propagation delay PL to TC		102 37 30	315 63 53		395 79 40		475 95 81	ns	2.0 4.5 6.0	Fig. 9
t <sub>PHL</sub>	propagation delay MR to TC		83 30 24	275 55 47		345 69 59		415 83 71	ns	2.0 4.5 6.0	Fig. 9
t <sub>THL</sub> / t <sub>TLH</sub>	output transition time		19 7 6	75 15 13		95 19 16		110 22 19	ns	2.0 4.5 6.0	Figs 7 and 8
t <sub>W</sub>	clock pulse width HIGH or LOW	165 33 28	22 8 6		205 41 35		250 50 43	ns	2.0 4.5 6.0	Fig. 7	
t <sub>W</sub>	master reset pulse width LOW	125 25 21	39 14 11		155 31 26		190 38 32	ns	2.0 4.5 6.0	Fig. 9	
t <sub>W</sub>	preset enable pulse width P <sub>L</sub> ; LOW	125 25 21	33 12 10		155 31 26		190 38 32	ns	2.0 4.5 6.0	Fig. 9	
t <sub>rem</sub>	removal time MR to CP or P <sub>L</sub> to CP	50 10 9	14 5 4		65 13 11		75 15 13	ns	2.0 4.5 6.0	Fig. 10	
t <sub>su</sub>	set-up time P <sub>E</sub> to CP	75 15 13	22 8 6		95 19 16		110 22 19	ns	2.0 4.5 6.0	Fig. 11	
t <sub>su</sub>	set-up time T <sub>E</sub> to CP	150 30 26	44 16 13		190 38 33		225 45 38	ns	2.0 4.5 6.0	Fig. 11	
t <sub>su</sub>	set-up time P <sub>n</sub> to CP	75 15 13	22 8 6		95 19 16		110 22 19	ns	2.0 4.5 6.0	Fig. 12	
t <sub>h</sub>	hold time P <sub>E</sub> to CP	0 0 0	-14 -5 -4		0 0 0		0 0 0	ns	2.0 4.5 6.0	Fig. 11	

## AC CHARACTERISTICS FOR 74HC (Cont'd)

GND = 0 V;  $t_r = t_f = 6$  ns;  $C_L = 50$  pF

SYMBOL	PARAMETER	T <sub>amb</sub> (°C)						UNIT	TEST CONDITIONS		
		74HC							V <sub>CC</sub> V	WAVEFORMS	
		+25			-40 to +85		-40 to +125				
		min.	typ.	max.	min.	max.	min.				max.
t <sub>h</sub>	hold time TE to CP	0 0 0	-30 -11 -9		0 0 0		0 0 0	ns	2.0 4.5 6.0	Fig. 11	
t <sub>h</sub>	hold time P <sub>n</sub> to CP	0 0 0	-17 -6 -5		0 0 0		0 0 0	ns	2.0 4.5 6.0	Fig. 12	
f <sub>max</sub>	maximum clock pulse frequency	3.0 15 18	10 29 35		2.4 12 14		2.0 10 12	MHz	2.0 4.5 6.0	Fig. 7	

**DC CHARACTERISTICS FOR 74HCT**

For the DC characteristics see chapter "HCMOS family characteristics", section "Family specifications".

Output capability: standard

I<sub>CC</sub> category: MSI

**Note to HCT types**

The value of additional quiescent supply current ( $\Delta I_{CC}$ ) for a unit load of 1 is given in the family specifications.

To determine  $\Delta I_{CC}$  per input, multiply this value by the unit load coefficient shown in the table below.

INPUT	UNIT LOAD COEFFICIENT
CP, PE	1.50
MR	1.00
TE	0.80
PL	0.35
P <sub>n</sub>	0.25

**AC CHARACTERISTICS FOR 74HCT**

GND = 0 V; t<sub>r</sub> = t<sub>f</sub> = 6 ns; C<sub>L</sub> = 50 pF

SYMBOL	PARAMETER	T <sub>amb</sub> (°C)						UNIT	TEST CONDITIONS		
		74HCT							V <sub>CC</sub> V	WAVEFORMS	
		+25			-40 to +85		-40 to +125				
		min.	typ.	max.	min.	max.	min.				max.
t <sub>PHL</sub> / t <sub>PLH</sub>	propagation delay CP to TC		35	60		75		90	ns	4.5	Fig. 7
t <sub>PHL</sub> / t <sub>PLH</sub>	propagation delay TE to TC		23	40		50		60	ns	4.5	Fig. 8
t <sub>PHL</sub> / t <sub>PLH</sub>	propagation delay PL to TC		44	75		94		112	ns	4.5	Fig. 9
t <sub>PHL</sub>	propagation delay MR to TC		29	55		69		83	ns	4.5	Fig. 9
t <sub>THL</sub> / t <sub>TLH</sub>	output transition time		7	15		19		22	ns	4.5	Figs. 7 and 8
t <sub>W</sub>	clock pulse width HIGH or LOW	33	10		41		50		ns	4.5	Fig. 7
t <sub>W</sub>	master reset pulse width LOW	30	16		38		45		ns	4.5	Fig. 9
t <sub>W</sub>	preset enable pulse width PL; LOW	38	22		48		57		ns	4.5	Fig. 9
t <sub>rem</sub>	removal time MR to CP or PL to CP	10	1		13		15		ns	4.5	Fig. 10
t <sub>su</sub>	set-up time PE to CP	20	11		25		30		ns	4.5	Fig. 11
t <sub>su</sub>	set-up time TE to CP	40	20		50		60		ns	4.5	Fig. 11
t <sub>su</sub>	set-up time P <sub>n</sub> to CP	20	11		25		30		ns	4.5	Fig. 12
t <sub>h</sub>	hold time PE to CP	2	-3		2		2		ns	4.5	Fig. 11

SYMBOL	PARAMETER	T <sub>amb</sub> (°C)						UNIT	TEST CONDITIONS		
		74HCT							V <sub>CC</sub> V	WAVEFORMS	
		+25			-40 to +85		-40 to +125				
		min.	typ.	max.	min.	max.	min.				max.
t <sub>h</sub>	hold time T <sub>E</sub> to CP	0	-10		0		0		ns	4.5	Fig. 11
t <sub>h</sub>	hold time P <sub>N</sub> to CP	0	-5		0		0		ns	4.5	Fig. 12
f <sub>max</sub>	maximum clock pulse frequency	15	28		12		10		MHz	4.5	Fig. 7

## AC WAVEFORMS

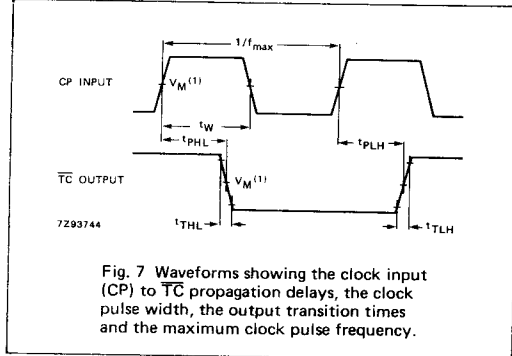

Fig. 7 Waveforms showing the clock input (CP) to  $\overline{TC}$  propagation delays, the clock pulse width, the output transition times and the maximum clock pulse frequency.

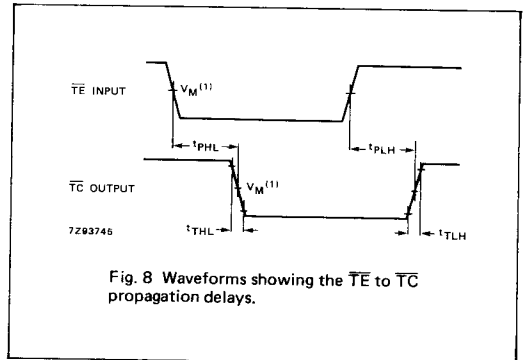

Fig. 8 Waveforms showing the  $\overline{TE}$  to  $\overline{TC}$  propagation delays.

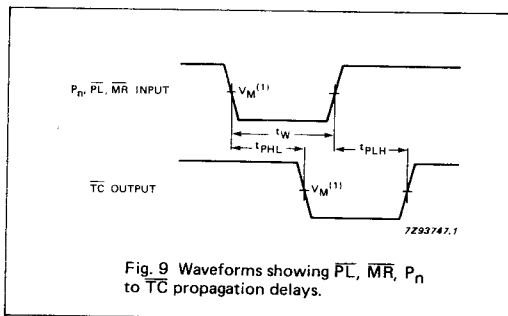

Fig. 9 Waveforms showing  $\overline{PL}$ ,  $\overline{MR}$ ,  $P_n$  to  $\overline{TC}$  propagation delays.

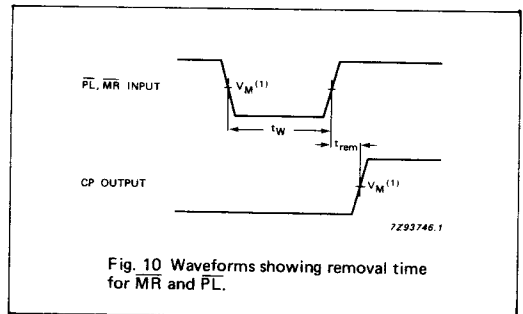

Fig. 10 Waveforms showing removal time for  $\overline{MR}$  and  $\overline{PL}$ .

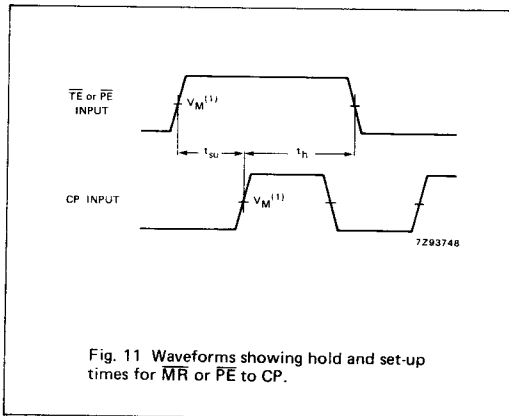

Fig. 11 Waveforms showing hold and set-up times for  $\overline{MR}$  or  $\overline{PE}$  to CP.

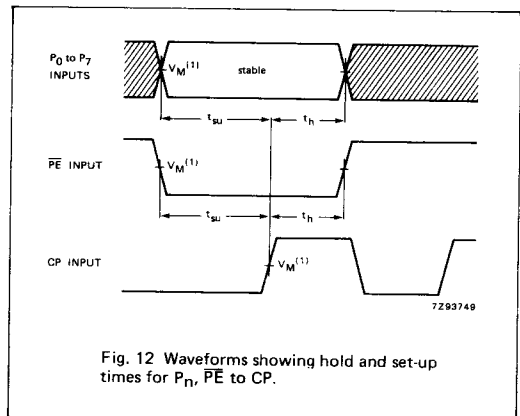

Fig. 12 Waveforms showing hold and set-up times for  $P_n$ ,  $\overline{PE}$  to CP.

## Note to AC waveforms

- (1) HC :  $V_M = 50\%$ ;  $V_I = \text{GND}$  to  $V_{CC}$ .  
HCT:  $V_M = 1.3 \text{ V}$ ;  $V_I = \text{GND}$  to  $3 \text{ V}$ .

## Note to Fig. 12

The shaded areas indicate when the input is permitted to change for predictable output performance.



APPLICATION INFORMATION

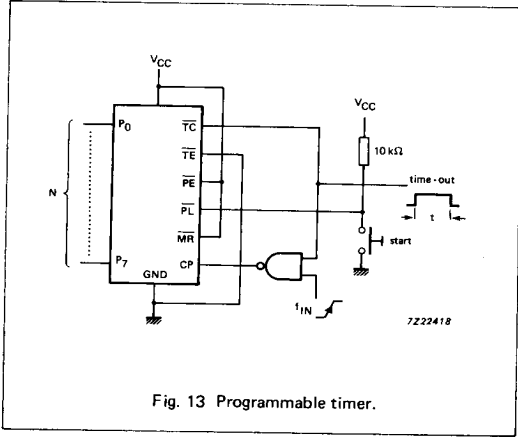

Fig. 13 Programmable timer.

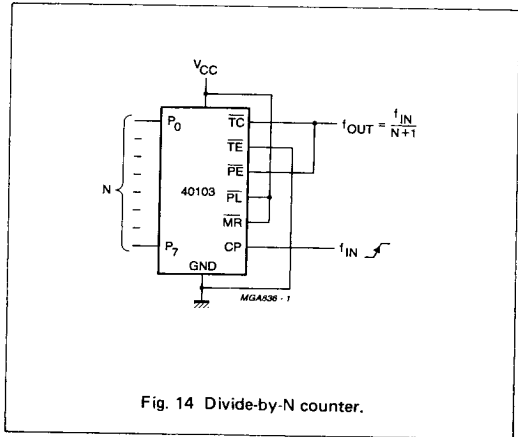

Fig. 14 Divide-by-N counter.