

DUAL 4-CHANNEL ANALOG MULTIPLEXER/DEMULTIPLEXER

FEATURES

- Wide analog input voltage range: $\pm 5\text{ V}$.
- Low "ON" resistance:
80 Ω (typ.) at $V_{CC} - V_{EE} = 4.5\text{ V}$
70 Ω (typ.) at $V_{CC} - V_{EE} = 6.0\text{ V}$
60 Ω (typ.) at $V_{CC} - V_{EE} = 9.0\text{ V}$
- Logic level translation:
to enable 5 V logic to communicate with $\pm 5\text{ V}$ analog signals
- Typical "break before make" built in
- Output capability: non-standard
- I_{CC} category: MSI

GENERAL DESCRIPTION

The 74HC/HCT4052 are high-speed Si-gate CMOS devices and are pin compatible with the "4052" of the "4000B" series. They are specified in compliance with JEDEC standard no. 7A.

The 74HC/HCT4052 are dual 4-channel analog multiplexers/demultiplexers with common select logic. Each multiplexer has four independent inputs/outputs (nY₀ to nY₃) and a common input/output (nZ). The common channel select logics include two digital select inputs (S₀ and S₁) and an active LOW enable input (E).

With E LOW, one of the four switches is selected (low impedance ON-state) by S₀ and S₁. With E HIGH, all switches are in the high impedance OFF-state, independent of S₀ and S₁.

V_{CC} and GND are the supply voltage pins for the digital control inputs (S₀ and S₁, and E). The V_{CC} to GND ranges are 2.0 to 10.0 V for HC and 4.5 to 5.5 V for HCT. The analog inputs/outputs (nY₀ to nY₃, and nZ) can swing between V_{CC} as a positive limit and V_{EE} as a negative limit. V_{CC} - V_{EE} may not exceed 10.0 V.

For operation as a digital multiplexer/demultiplexer, V_{EE} is connected to GND (typically ground).

| SYMBOL | PARAMETER | CONDITIONS | TYPICAL | | UNIT |
|--|---|--|---------|-----|------|
| | | | HC | HCT | |
| t _{PZH} / t _{PZL} | turn "ON" time E or S _N to V _{OS} | C _L = 15 pF R _L = 1 k Ω V _{CC} = 5 V | 28 | 18 | ns |
| t _{PHZ} / t _{PLZ} | turn "OFF" time E or S _N to V _{OS} | | 21 | 13 | ns |
| C _I | input capacitance | | 3.5 | 3.5 | pF |
| C _{PD} | power dissipation capacitance per switch | notes 1 and 2 | 57 | 57 | pF |
| C _S | max. switch capacitance independent (Y) common (Z) | | 5 | 5 | pF |
| | | | 12 | 12 | pF |

V_{EE} = GND = 0 V; T_{amb} = 25 °C; t_r = t_f = 6 ns

Notes

1. C_{PD} is used to determine the dynamic power dissipation (P_D in μW):

$$P_D = C_{PD} \times V_{CC}^2 \times f_i + \sum \{ (C_L + C_S) \times V_{CC}^2 \times f_o \}$$

f_i = input frequency in MHz
f_o = output frequency in MHz
 $\sum \{ (C_L + C_S) \times V_{CC}^2 \times f_o \}$ = sum of outputs
C_L = output load capacitance in pF
C_S = max. switch capacitance in pF
V_{CC} = supply voltage in V

2. For HC the condition is V_I = GND to V_{CC}
For HCT the condition is V_I = GND to V_{CC} - 1.5 V

PACKAGE OUTLINES

16-lead DIL; plastic (SOT38Z).
16-lead mini-pack; plastic (SO16; SOT109A).

PIN DESCRIPTION

| PIN NO. | SYMBOL | NAME AND FUNCTION |
|----------------|------------------------------------|----------------------------|
| 1, 5, 2, 4 | 2Y ₀ to 2Y ₃ | independent inputs/outputs |
| 6 | E | enable input (active LOW) |
| 7 | V _{EE} | negative supply voltage |
| 8 | GND | ground (0 V) |
| 10, 9 | S ₀ , S ₁ | select inputs |
| 12, 14, 15, 11 | 1Y ₀ to 1Y ₃ | independent inputs/outputs |
| 13, 3 | 1Z, 2Z | common inputs/outputs |
| 16 | V _{CC} | positive supply voltage |

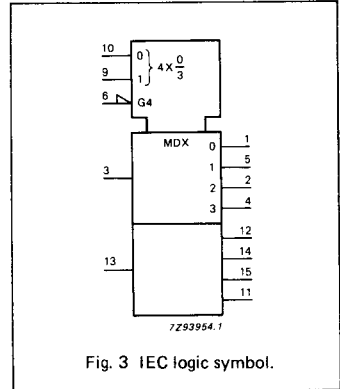
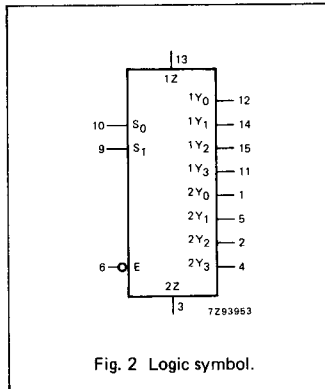
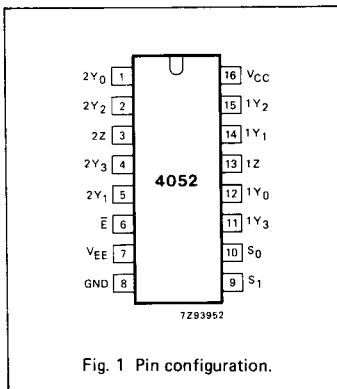

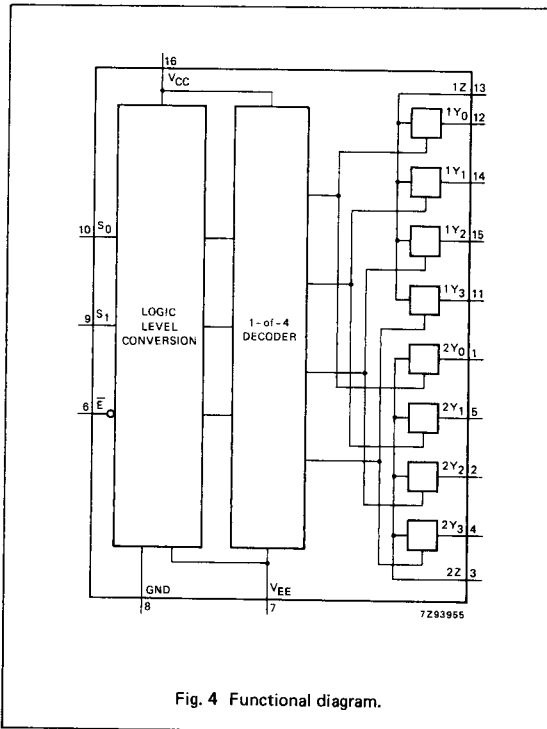

Fig. 4 Functional diagram.

APPLICATIONS

- Analog multiplexing and demultiplexing
- Digital multiplexing and demultiplexing
- Signal gating

FUNCTION TABLE

| INPUTS | | | CHANNEL ON |
|--------|----------------|----------------|----------------------|
| E | S ₁ | S ₀ | |
| L | L | L | nY ₀ - nZ |
| L | L | H | nY ₁ - nZ |
| L | H | L | nY ₂ - nZ |
| L | H | H | nY ₃ - nZ |
| H | X | X | none |

H = HIGH voltage level
L = LOW voltage level
X = don't care

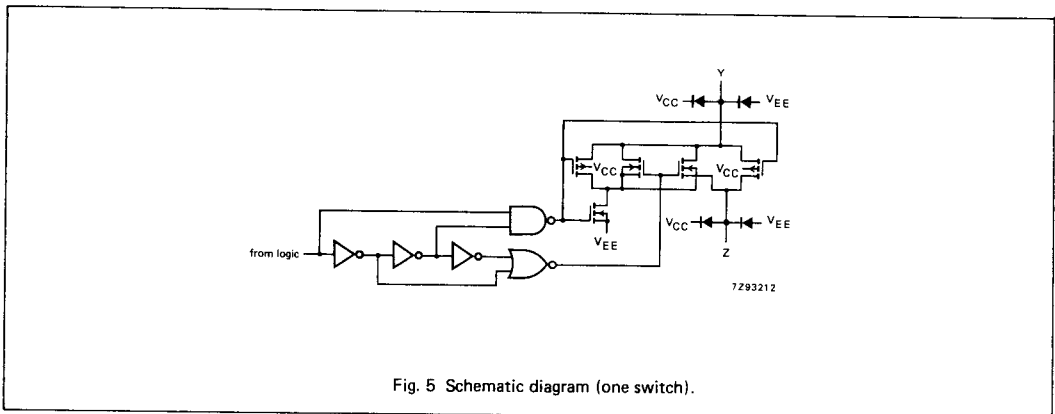

Fig. 5 Schematic diagram (one switch).

RATINGS

Limiting values in accordance with the Absolute Maximum System (IEC 134)

Voltages are referenced to $V_{EE} = \text{GND}$ (ground = 0 V)

| SYMBOL | PARAMETER | MIN. | MAX. | UNIT | CONDITIONS |
|---------------------------------|--------------------------------|------|-------|------|--|
| V_{CC} | DC supply voltage | -0.5 | +11.0 | V | |
| $\pm I_{IK}$ | DC digital input diode current | | 20 | mA | for $V_I < -0.5 \text{ V}$ or $V_I > V_{CC} + 0.5 \text{ V}$ |
| $\pm I_{SK}$ | DC switch diode current | | 20 | mA | for $V_S < -0.5 \text{ V}$ or $V_S > V_{CC} + 0.5 \text{ V}$ |
| $\pm I_S$ | DC switch current | | 25 | mA | for $-0.5 \text{ V} < V_S < V_{CC} + 0.5 \text{ V}$ |
| $\pm I_{EE}$ | DC V_{EE} current | | 20 | mA | |
| $\pm I_{CC}$; $\pm I_{GND}$ | DC V_{CC} or GND current | | 50 | mA | |
| T_{stg} | storage temperature range | -65 | +150 | °C | |
| P_{tot} | power dissipation per package | | | | for temperature range: -40 to +125 °C 74HC/HCT |
| | plastic DIL | | 750 | mW | above +70 °C: derate linearly with 12 mW/K |
| | plastic mini-pack (SO) | | 500 | mW | above +70 °C: derate linearly with 8 mW/K |
| P_S | power dissipation per switch | | 100 | mW | |

Note to ratings

To avoid drawing V_{CC} current out of terminals nZ, when switch current flows in terminals nY_n, the voltage drop across the bidirectional switch must not exceed 0.4 V. If the switch current flows into terminals nZ, no V_{CC} current will flow out of terminals nY_n. In this case there is no limit for the voltage drop across the switch, but the voltages at nY_n and nZ may not exceed V_{CC} or V_{EE} .

RECOMMENDED OPERATING CONDITIONS

| SYMBOL | PARAMETER | 74HC | | | 74HCT | | | UNIT | CONDITIONS |
|------------|---------------------------------------|----------|------|---------------------------|----------|------|----------|------|---|
| | | min. | typ. | max. | min. | typ. | max. | | |
| V_{CC} | DC supply voltage V_{CC} -GND | 2.0 | 5.0 | 10.0 | 4.5 | 5.0 | 5.5 | V | see Figs 6 and 7 |
| V_{CC} | DC supply voltage V_{CC} - V_{EE} | 2.0 | 5.0 | 10.0 | 2.0 | 5.0 | 10.0 | V | see Figs 6 and 7 |
| V_I | DC input voltage range | GND | | V_{CC} | GND | | V_{CC} | V | |
| V_S | DC switch voltage range | V_{EE} | | V_{CC} | V_{EE} | | V_{CC} | V | |
| T_{amb} | operating ambient temperature range | -40 | | +85 | -40 | | +85 | °C | see DC and AC CHARACTERISTICS |
| T_{amb} | operating ambient temperature range | -40 | | +125 | -40 | | +125 | °C | |
| t_r, t_f | input rise and fall times | | 6.0 | 1000 500 400 250 | | 6.0 | 500 | ns | $V_{CC} = 2.0 \text{ V}$ $V_{CC} = 4.5 \text{ V}$ $V_{CC} = 6.0 \text{ V}$ $V_{CC} = 10.0 \text{ V}$ |

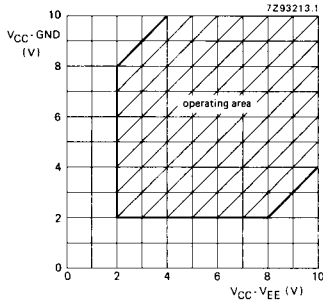

Fig. 6 Guaranteed operating area as a function of the supply voltages for 74HC4052.

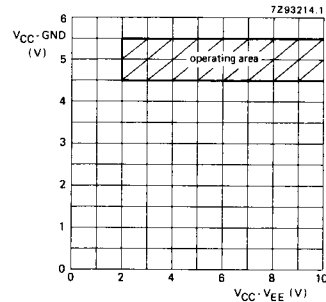

Fig. 7 Guaranteed operating area as a function of the supply voltages for 74HCT4052.

DC CHARACTERISTICS FOR 74HC/HCT

For 74HC: $V_{CC} - GND$ or $V_{CC} - V_{EE} = 2.0, 4.5, 6.0$ and 9.0 V

For 74HCT: $V_{CC} - GND = 4.5$ and 5.5 V; $V_{CC} - V_{EE} = 2.0, 4.5, 6.0$ and 9.0 V

| SYMBOL | PARAMETER | T _{amb} (°C) | | | | | | UNIT | TEST CONDITIONS | | | | |
|------------------|---|-----------------------|------|------|------------|------|-------------|------|----------------------|----------------------|--|--|--|
| | | 74HC/HCT | | | | | | | V _{CC} V | V _{EE} V | I _S μA | V _{is} | V _I |
| | | +25 | | | -40 to +85 | | -40 to +125 | | | | | | |
| | | min. | typ. | max. | min. | max. | min. | | max. | | | | |
| R _{ON} | ON resistance (peak) | - | - | - | - | - | - | Ω | 2.0 | 0 | 100 | V _{CC} to V _{EE} | V _{IH} or V _{IL} |
| | | 100 | 180 | 225 | 270 | Ω | 4.5 | 0 | 1000 | | | | |
| | | 90 | 160 | 200 | 240 | Ω | 6.0 | 0 | 1000 | | | | |
| R _{ON} | ON resistance (rail) | 150 | - | - | - | - | Ω | 2.0 | 0 | 100 | V _{EE} | V _{IH} or V _{IL} | |
| | | 80 | 140 | 175 | 210 | Ω | 4.5 | 0 | 1000 | | | | |
| | | 70 | 120 | 150 | 180 | Ω | 6.0 | 0 | 1000 | | | | |
| R _{ON} | ON resistance (rail) | 150 | - | - | - | - | Ω | 2.0 | 0 | 100 | V _{CC} | V _{IH} or V _{IL} | |
| | | 90 | 160 | 200 | 240 | Ω | 4.5 | 0 | 1000 | | | | |
| | | 80 | 140 | 175 | 210 | Ω | 6.0 | 0 | 1000 | | | | |
| ΔR _{ON} | maximum ΔON resistance between any two channels | - | - | - | - | - | Ω | 2.0 | 0 | - | V _{CC} to V _{EE} | V _{IH} or V _{IL} | |
| | | 9 | - | - | - | Ω | 4.5 | 0 | - | | | | |
| | | 8 | - | - | - | Ω | 6.0 | 0 | - | | | | |
| | | 6 | - | - | - | - | Ω | 4.5 | -4.5 | - | | | |

Notes to DC characteristics

- At supply voltages ($V_{CC} - V_{EE}$) approaching 2.0 V the analog switch ON-resistance becomes extremely non-linear. There it is recommended that these devices be used to transmit digital signals only, when using these supply voltages.
- For test circuit measuring R_{ON} see Fig. 8.

DC CHARACTERISTICS FOR 74HC

Voltages are referenced to GND (ground = 0 V)

| SYMBOL | PARAMETER | T _{amb} (°C) | | | | | | UNIT | TEST CONDITIONS | | | | |
|-----------------|--|---------------------------|--------------------------|---------------------------|---------------------------|---------------------------|---------------------------|---------------------------|----------------------|--------------------------|----------------|--|--|
| | | 74HC | | | | | | | V _{CC} V | V _{EE} V | V _I | OTHER | |
| | | +25 | | | -40 to +85 | | -40 to +125 | | | | | | |
| | | min. | typ. | max. | min. | max. | min. | | | | | | max. |
| V _{IH} | HIGH level input voltage | 1.5 3.15 4.2 6.3 | 1.2 2.4 3.2 4.7 | | 1.5 3.15 4.2 6.3 | | 1.5 3.15 4.2 6.3 | | V | 2.0 4.5 6.0 9.0 | | | |
| V _{IL} | LOW level input voltage | | 0.8 2.1 2.8 4.3 | 0.5 1.35 1.8 2.7 | | 0.5 1.35 1.8 2.7 | | 0.5 1.35 1.8 2.7 | V | 2.0 4.5 6.0 9.0 | | | |
| ±I _i | input leakage current | | | 0.1 0.2 | | 1.0 2.0 | | 1.0 2.0 | μA | 6.0 10.0 | 0 0 | V _{CC} or GND | |
| ±I _S | analog switch OFF-state current per channel | | | 0.1 | | 1.0 | | 1.0 | μA | 10.0 | 0 | V _{IH} or V _{IL} | V _S = V _{CC} - V _{EE} (see Fig. 10) |
| ±I _S | analog switch OFF-state current all channels | | | 0.2 | | 2.0 | | 2.0 | μA | 10.0 | 0 | V _{IH} or V _{IL} | V _S = V _{CC} - V _{EE} (see Fig. 10) |
| ±I _S | analog switch ON-state current | | | 0.2 | | 2.0 | | 2.0 | μA | 10.0 | 0 | V _{IH} or V _{IL} | V _S = V _{CC} - V _{EE} (see Fig. 11) |
| I _{CC} | quiescent supply current | | | 8.0 16.0 | | 80.0 160.0 | | 160.0 320.0 | μA | 6.0 10.0 | 0 0 | V _{CC} or GND | V _{is} = V _{EE} or V _{CC} ; V _{os} = V _{CC} or V _{EE} |

AC CHARACTERISTICS FOR 74HC

GND = 0 V; t_r = t_f = 6 ns; C_L = 50 pF

| SYMBOL | PARAMETER | T _{amb} (°C) | | | | | | UNIT | TEST CONDITIONS | | | |
|--|--|-----------------------|-----------------------|-----------------------|------------|-----------------------|-------------|-----------------------|----------------------|--------------------------|---------------------|---|
| | | 74HC | | | | | | | V _{CC} V | V _{EE} V | OTHER | |
| | | +25 | | | -40 to +85 | | -40 to +125 | | | | | |
| | | min. | typ. | max. | min. | max. | min. | | | | | max. |
| t _{PHL} / t _{PLH} | propagation delay V _{is} to V _{Os} | | 14 5 4 4 | 60 12 10 8 | | 75 15 13 10 | | 90 18 15 12 | ns | 2.0 4.5 6.0 4.5 | 0 0 0 -4.5 | R _L = ∞; C _L = 50 pF (see Fig. 18) |
| t _{PZH} / t _{PZL} | turn "ON" time Ē to V _{Os} S _n to V _{Os} | | 105 38 30 26 | 325 65 55 46 | | 405 81 69 58 | | 490 98 83 69 | ns | 2.0 4.5 6.0 4.5 | 0 0 0 -4.5 | R _L = ∞; C _L = 50 pF (see Figs 19, 20 and 21) |
| t _{PHZ} / t _{PLZ} | turn "OFF" time Ē to V _{Os} S _n to V _{Os} | | 74 27 22 22 | 250 50 43 38 | | 315 63 54 48 | | 375 75 64 57 | ns | 2.0 4.5 6.0 4.5 | 0 0 0 -4.5 | R _L = 1 kΩ; C _L = 50 pF (see Figs 19, 20 and 21) |

DC CHARACTERISTICS FOR 74HCT

Voltages are referenced to GND (ground = 0)

| SYMBOL | PARAMETER | T _{amb} (°C) | | | | | | UNIT | TEST CONDITIONS | | | | |
|------------------|---|-----------------------|------|-------------|------------|---------------|-------------|----------------|----------------------|----------------------|----------------|------------------------------------|--|
| | | 74HCT | | | | | | | V _{CC} V | V _{EE} V | V _I | OTHER | |
| | | +25 | | | -40 to +85 | | -40 to +125 | | | | | | |
| | | min. | typ. | max. | min. | max. | min. | | | | | | max. |
| V _{IH} | HIGH level input voltage | 2.0 | 1.6 | | 2.0 | | 2.0 | | V | 4.5 to 5.5 | | | |
| V _{IL} | LOW level input voltage | | 1.2 | 0.8 | | 0.8 | | 0.8 | V | 4.5 to 5.5 | | | |
| ±I _I | input leakage current | | | 0.1 | | 1.0 | | 1.0 | μA | 5.5 | 0 | V _{CC} or GND | |
| ±I _S | analog switch OFF-state current per channel | | | 0.1 | | 1.0 | | 1.0 | μA | 10.0 | 0 | V _{IH} or V _{IL} | V _S = V _{CC} - V _{EE} (see Fig. 10) |
| ±I _S | analog switch OFF-state current all channels | | | 0.2 | | 2.0 | | 2.0 | μA | 10.0 | 0 | V _{IH} or V _{IL} | V _S = V _{CC} - V _{EE} (see Fig. 10) |
| ±I _S | analog switch ON-state current | | | 0.2 | | 2.0 | | 2.0 | μA | 10.0 | 0 | V _{IH} or V _{IL} | V _S = V _{CC} - V _{EE} (see Fig. 11) |
| I _{CC} | quiescent supply current | | | 8.0 16.0 | | 80.0 160.0 | | 160.0 320.0 | μA | 5.5 5.0 | 0 -5.0 | V _{CC} or GND | V _{is} = V _{EE} or V _{CC} ; V _{os} = V _{CC} or V _{EE} |
| ΔI _{CC} | additional quiescent supply current per input pin for unit load coefficient is 1 (note 1) | | 100 | 360 | | 450 | | 490 | μA | 4.5 to 5.5 | 0 | V _{CC} - 2.1V | other inputs at V _{CC} or GND |

Note to HCT types

- The value of additional quiescent supply current (ΔI_{CC}) for a unit load of 1 is given here. To determine ΔI_{CC} per input, multiply this value by the unit load coefficient in the table below.

| INPUT | UNIT LOAD COEFFICIENT |
|----------------|-----------------------|
| S _n | 0.45 |
| E | 0.45 |

AC CHARACTERISTICS FOR 74HCT

GND = 0 V; $t_r = t_f = 6$ ns; $C_L = 50$ pF

| SYMBOL | PARAMETER | T _{amb} (°C) | | | | | | UNIT | TEST CONDITIONS | | | |
|--|--|-----------------------|----------|----------|------------|----------|-------------|-----------|----------------------|----------------------|-----------|---|
| | | 74HCT | | | | | | | V _{CC} V | V _{EE} V | OTHER | |
| | | +25 | | | -40 to +85 | | -40 to +125 | | | | | |
| | | min. | typ. | max. | min. | max. | min. | | | | | max. |
| t _{pHL} / t _{pLH} | propagation delay V _{is} to V _{os} | | 5 4 | 12 8 | | 15 10 | | 18 12 | ns | 4.5 4.5 | 0 -4.5 | R _L = ∞; C _L = 50 pF (see Fig. 18) |
| t _{pZH} / t _{pZL} | turn "ON" time E to V _{os} S _n to V _{os} | | 41 28 | 70 48 | | 88 60 | | 105 72 | ns | 4.5 4.5 | 0 -4.5 | R _L = 1 kΩ; C _L = 50 pF (see Figs 19, 20 and 21) |
| t _{pHZ} / t _{pLZ} | turn "OFF" time E to V _{os} S _n to V _{os} | | 26 21 | 50 38 | | 63 48 | | 75 57 | ns | 4.5 4.5 | 0 -4.5 | R _L = 1 kΩ; C _L = 50 pF (see Figs 19, 20 and 21) |

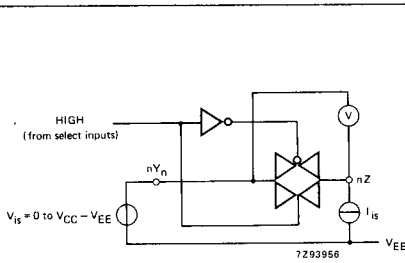

Fig. 8 Test circuit for measuring R_{ON}.

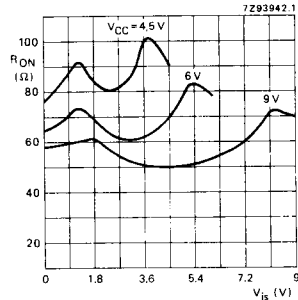

Fig. 9 Typical R_{ON} as a function of input voltage V_{is} for V_{is} = 0 to V_{CC} - V_{EE}.

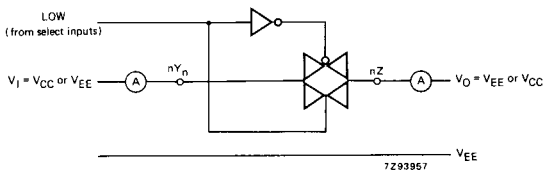
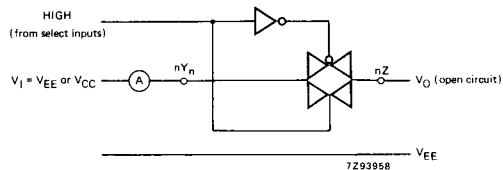

Fig. 10 Test circuit for measuring OFF-state current.

Fig. 11 Test circuit for measuring ON-state current.



ADDITIONAL AC CHARACTERISTICS FOR 74HC/HCT

Recommended conditions and typical values

GND = 0 V; T_{amb} = 25 °C

| SYMBOL | PARAMETER | typ. | UNIT | V _{CC} V | V _{EE} V | V _{is(p-p)} V | CONDITIONS |
|--------------------|---|--------------|------------|----------------------|----------------------|---------------------------|---|
| | sine-wave distortion f = 1 kHz | 0.04 0.02 | % % | 2.25 4.5 | -2.25 -4.5 | 4.0 8.0 | R _L = 10 kΩ; C _L = 50 pF (see Fig. 14) |
| | sine-wave distortion f = 10 kHz | 0.12 0.06 | % % | 2.25 4.5 | -2.25 -4.5 | 4.0 8.0 | R _L = 10 kΩ; C _L = 50 pF (see Fig. 14) |
| | switch "OFF" signal feed-through | -50 -50 | dB dB | 2.25 4.5 | -2.25 -4.5 | note 1 | R _L = 600 Ω; C _L = 50 pF; f = 1 MHz (see Figs 12 and 15) |
| | crosstalk between any two switches/ multiplexers | -60 -60 | dB dB | 2.25 4.5 | -2.25 -4.5 | note 1 | R _L = 600 Ω; C _L = 50 pF; f = 1 MHz (see Fig. 16) |
| V _(p-p) | crosstalk voltage between control and any switch (peak-to-peak value) | 110 220 | mV mV | 4.5 4.5 | 0 -4.5 | | R _L = 600 Ω; C _L = 50 pF; f = 1 MHz (E or S _n , square-wave between V _{CC} and GND, t _r = t _f = 6 ns) (see Fig. 17) |
| f _{max} | minimum frequency response (-3dB) | 170 180 | MHz MHz | 2.25 4.5 | -2.25 -4.5 | note 2 | R _L = 50 Ω; C _L = 50 pF (see Figs 13 and 14) |
| C _S | maximum switch capacitance independent (Y) common (Z) | 5 12 | pF pF | | | | |

Notes to AC characteristics

General note

V_{is} is the input voltage at an nY_n or nZ terminal, whichever is assigned as an input.
V_{os} is the output voltage at an nY_n or nZ terminal, whichever is assigned as an output.

Notes

1. Adjust input voltage V_{is} to 0 dBm level (0 dBm = 1 mW into 600 Ω).
2. Adjust input voltage V_{is} to 0 dBm level at V_{os} for 1 MHz (0 dBm = 1 mW into 50 Ω).

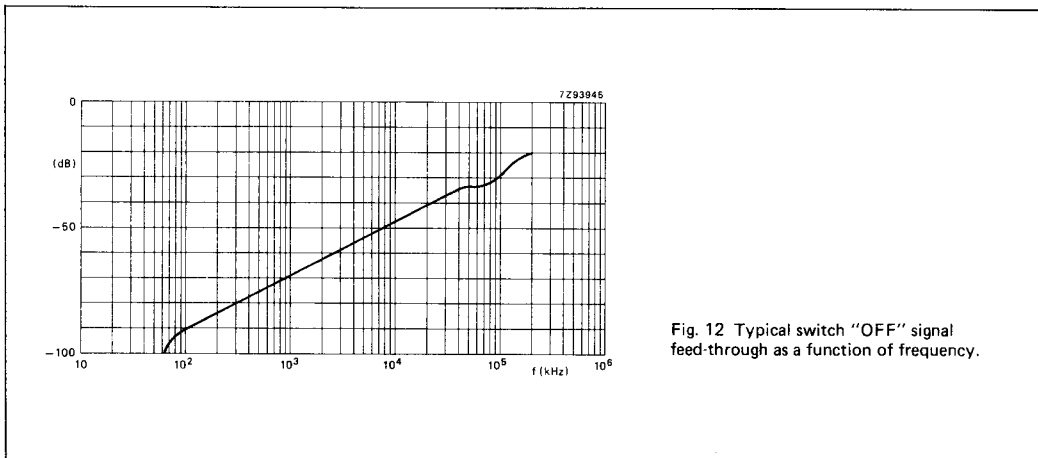
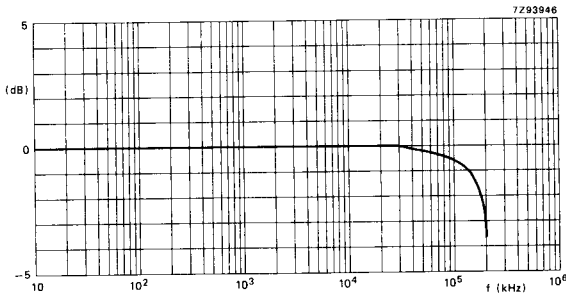

Fig. 12 Typical switch "OFF" signal feed-through as a function of frequency.



Note to Figs 12 and 13

Test conditions:
 $V_{CC} = 4.5 \text{ V}$; $GND = 0 \text{ V}$; $V_{EE} = -4.5 \text{ V}$;
 $R_L = 50 \Omega$; $R_{source} = 1 \text{ k}\Omega$.

Fig. 13 Typical frequency response.

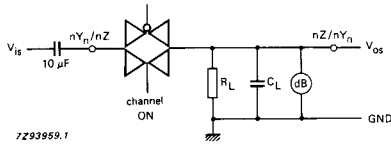

Fig. 14 Test circuit for measuring sine-wave distortion and minimum frequency response.

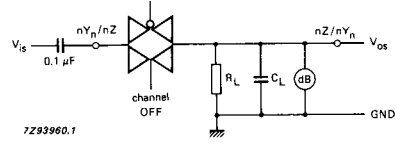

Fig. 15 Test circuit for measuring switch "OFF" signal feed-through.

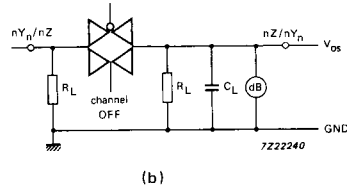
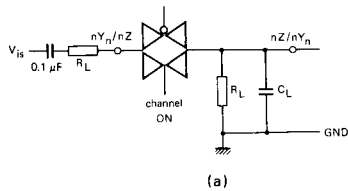

Fig. 16 Test circuits for measuring crosstalk between any two switches/multiplexers.
(a) channel ON condition; (b) channel OFF condition.

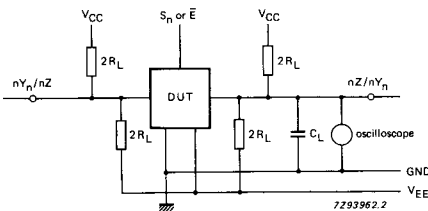
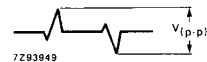

Fig. 17 Test circuit for measuring crosstalk between control and any switch.

Note to Fig. 17

The crosstalk is defined as follows (oscilloscope output):



AC WAVEFORMS

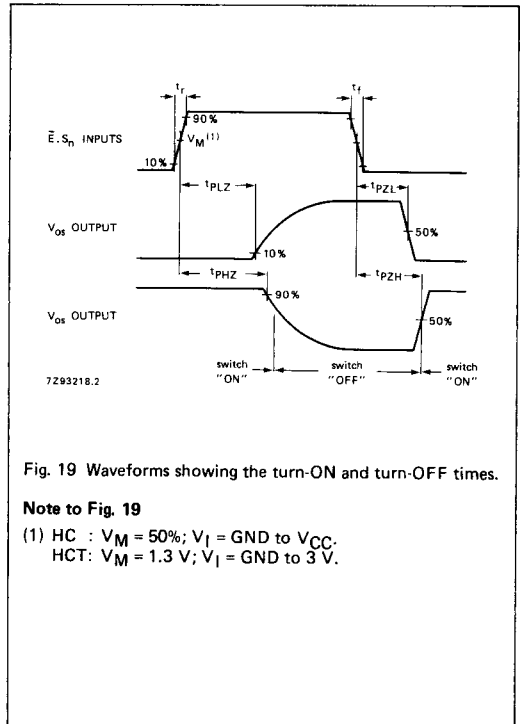
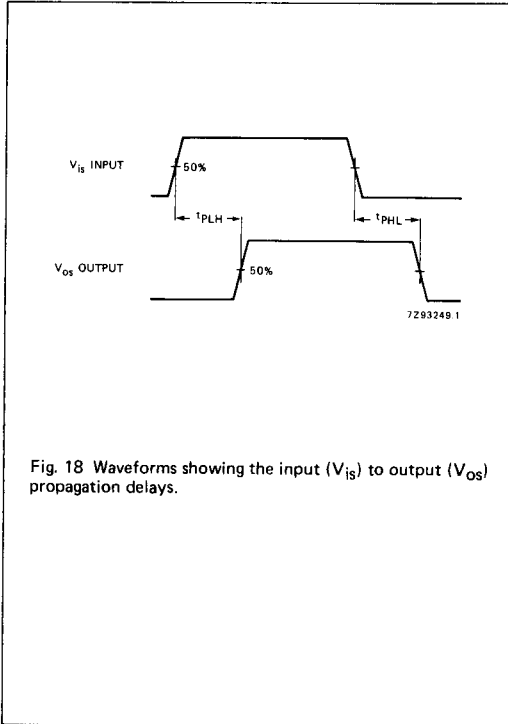

Note to Fig. 19

- (1) HC : $V_M = 50\%$; $V_I = \text{GND to } V_{CC}$.
- HCT: $V_M = 1.3 \text{ V}$; $V_I = \text{GND to } 3 \text{ V}$.

TEST CIRCUIT AND WAVEFORMS

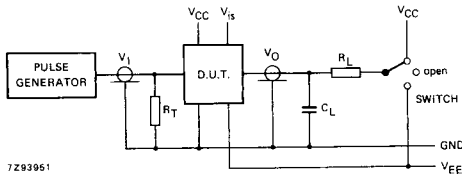

Fig. 20 Test circuit for measuring AC performance.

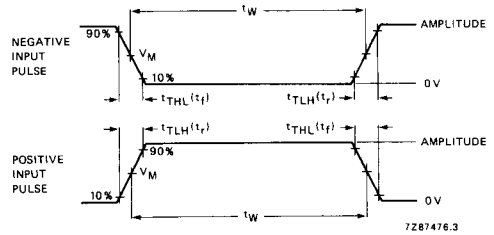

Fig. 21 Input pulse definitions.

Conditions

| TEST | SWITCH | V _{is} |
|------------------|-----------------|-----------------|
| t _{pZH} | V _{EE} | V _{CC} |
| t _{pZL} | V _{CC} | V _{EE} |
| t _{pHZ} | V _{EE} | V _{CC} |
| t _{pLZ} | V _{CC} | V _{EE} |
| others | open | pulse |

| FAMILY | AMPLITUDE | V _M | t _r ; t _f | |
|--------|-----------------|----------------|---------------------------------|-------|
| | | | f _{max} ; PULSE WIDTH | OTHER |
| 74HC | V _{CC} | 50% | < 2 ns | 6 ns |
| 74HCT | 3.0 V | 1.3 V | < 2 ns | 6 ns |

Definitions for Figs 20 and 21:

C_L = load capacitance including jig and probe capacitance (see AC CHARACTERISTICS for values).

R_T = termination resistance should be equal to the output impedance Z_O of the pulse generator.

t_r = t_f = 6 ns; when measuring f_{max}, there is no constraint to t_r, t_f with 50% duty factor.