

PC865 Series

High Sensitivity, Low Collector Dark Current, High Collector-emitter Voltage Type Photocoupler

■ Features

1. Low collector dark current
(I_{CEO} : MAX. 10 μ A at $V_{CE} = 24V$, $T_a = 85^\circ C$)
2. High current transfer ratio
(CTR : MIN. 1 000% at $I_F = 1mA$, $V_{CE} = 2V$)
3. High collector-emitter voltage (V_{CEO} : 70V)
4. High isolation voltage between input and output (V_{iso} : 5 000V_{rms})
5. Compact dual-in-line package
PC865 (1-channel) **PC875** (2-channel)
PC895 (4-channel)
6. Recognized by UL, file No. E64380

■ Applications

1. Programmable controllers
2. System appliances, measuring instruments
3. Copiers, automatic vending machines
4. Signal transmission between circuits of different potentials and impedances

■ Outline Dimensions

(Unit : mm)

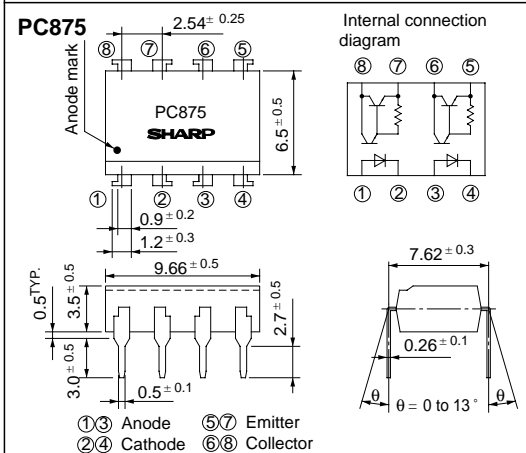
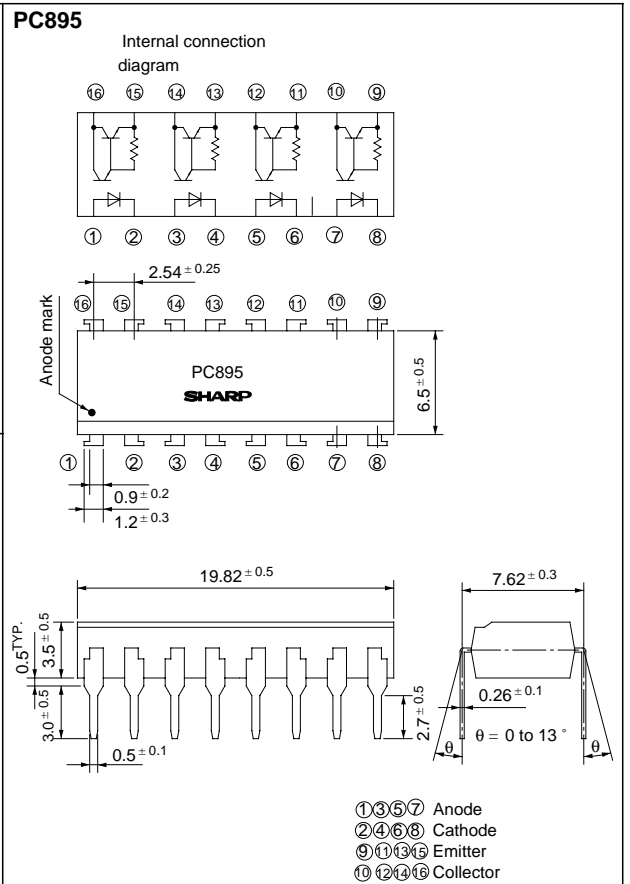
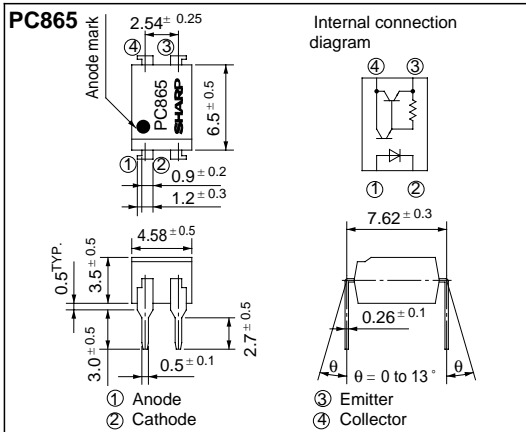

"In the absence of confirmation by device specification sheets, SHARP takes no responsibility for any defects that occur in equipment using any of SHARP's devices, shown in catalogs, data books, etc. Contact SHARP in order to obtain the latest version of the device specification sheets before using any SHARP's device."

■ Absolute Maximum Ratings

(Ta = 25 °C)

Parameter		Symbol	Rating	Unit
Input	Forward current	I _F	50	mA
	*1Peak forward current	I _{FM}	1	A
	Reverse voltage	V _R	6	V
	Power dissipation	P	70	mW
Output	Collector-emitter voltage	V _{CEO}	70	V
	Emitter-collector voltage	V _{ECCO}	0.1	V
	Collector current	I _C	80	mA
	Collector power dissipation	P _C	150	mW
Total power dissipation		P _{tot}	200	mW
*2Isolation voltage		V _{iso}	5 000	V _{rms}
Operating temperature		T _{opr}	- 30 to + 100	°C
Storage temperature		T _{stg}	- 55 to + 125	°C
*3Soldering temperature		T _{sol}	260	°C

*1 Pulse width ≤ 100 μs, Duty ratio : 0.001

*2 40 to 60 % RH, AC for 1 minute

*3 For 10 seconds

■ Electro-optical Characteristics

(Ta = 25 °C)

Parameter		Symbol	Conditions	MIN.	TYP.	MAX.	Unit	
Input	Forward voltage	V _F	I _F = 20mA	-	1.2	1.4	V	
	Reverse current	I _R	V _R = 4V	-	-	10	μA	
	Terminal capacitance	C _t	V = 0, f = 1kHz	-	30	250	pF	
Output	Collector dark current	I _{CEO}	V _{CE} = 24V I _F = 0	Ta = 25 °C	-	-	2 x 10 ⁻⁷	A
				Ta = 85 °C	-	-	10 ⁻⁵	A
Transfer characteristics	Current transfer ratio	CTR	I _F = 1mA, V _{CE} = 2V	1 000	-	8 000	%	
	Collector-emitter saturation voltage	V _{CE(sat)}	I _F = 20mA, I _C = 5mA	-	0.8	1.0	V	
	Isolation resistance	R _{iso}	DC500V, 40 to 60 % RH	5 x 10 ¹⁰	10 ¹¹	-	Ω	
	Floating capacitance	C _f	V = 0, f = 1MHz	-	0.6	1.0	pF	
	Cut-off frequency	f _c	V _{CE} = 2V, I _C = 2mA, R _L = 100 Ω, - 3dB	1	6	-	kHz	
	Response time	Rise time	t _r	V _{CE} = 2V, I _C = 10mA R _L = 100 Ω	-	100	300	μs
Fall time		t _f	-		35	200	μs	

Fig. 1 Forward Current vs. Ambient Temperature

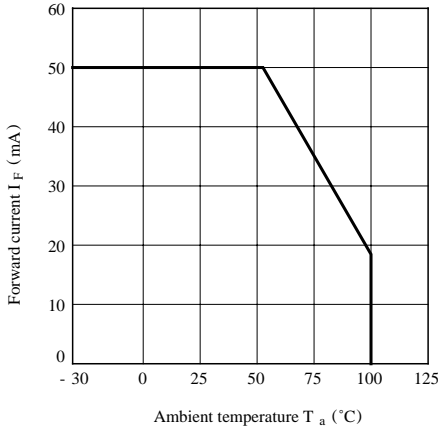

Fig. 2 Collector Power Dissipation vs. Ambient Temperature

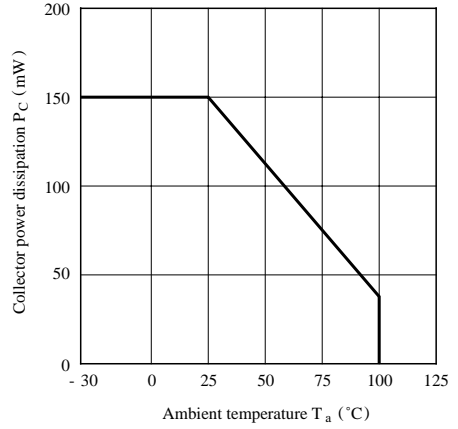

Fig. 3 Peak Forward Current vs. Duty Ratio

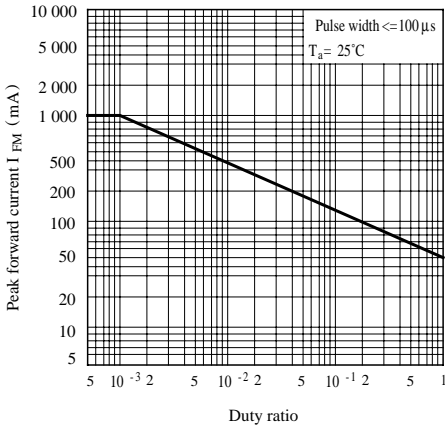

Fig. 4 Forward Current vs. Forward Voltage

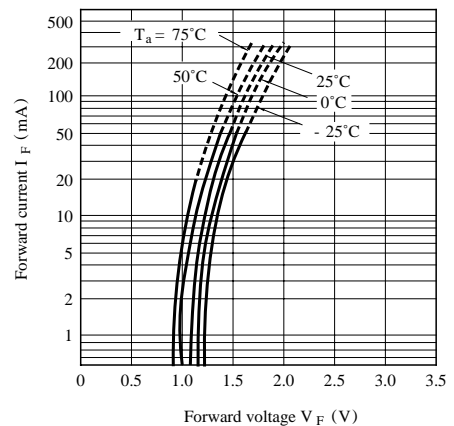

Fig. 5 Current Transfer Ratio vs. Forward Current

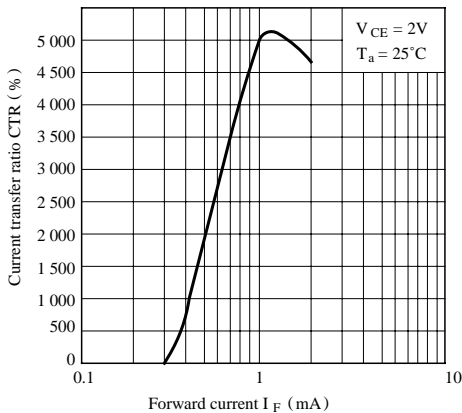

Fig. 6 Collector Current vs. Collector-emitter Voltage

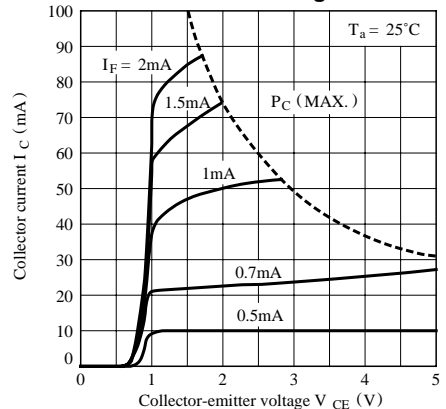

Fig. 7 Relative Current Transfer Ratio vs. Ambient Temperature

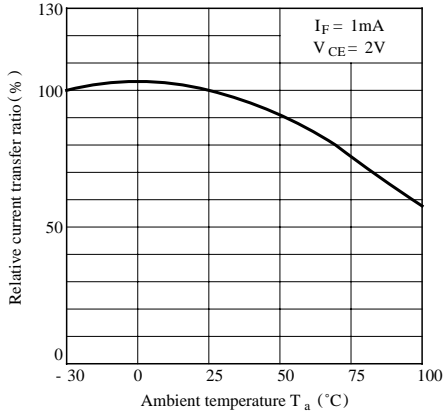

Fig. 8 Collector-emitter Saturation Voltage vs. Ambient Temperature

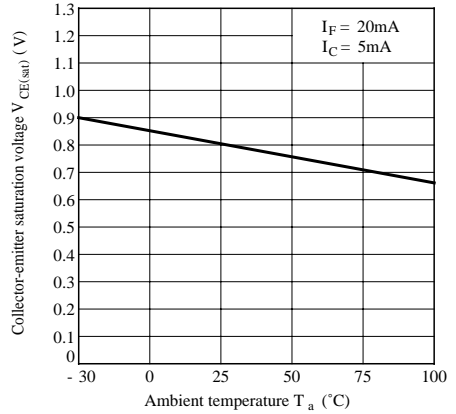

Fig. 9 Collector Dark Current vs. Ambient Temperature

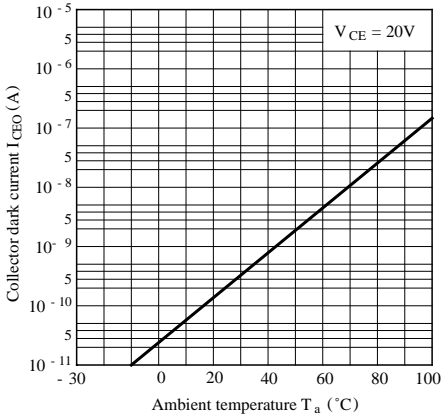

Fig.10 Response Time vs. Load Resistance

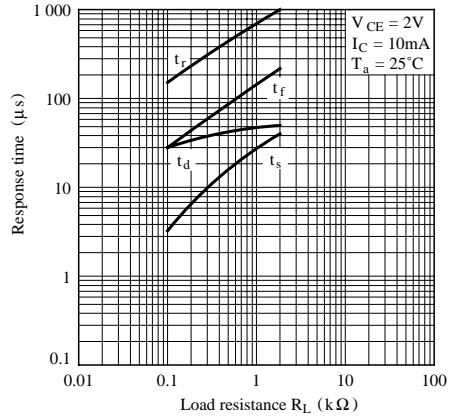
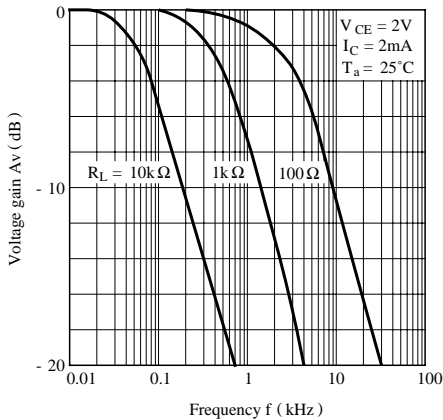
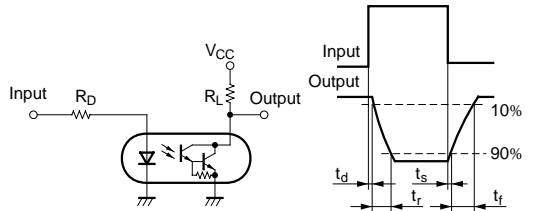

Fig.11 Frequency Response



Test Circuit for Response Time



Test Circuit for Frequency Response

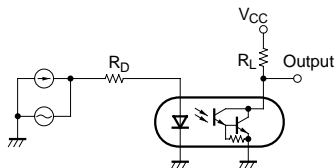
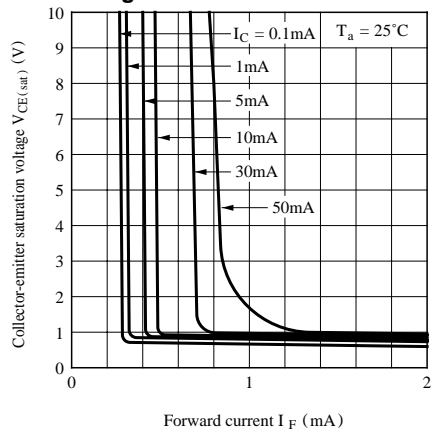

Fig.12 Collector-emitter Saturation Voltage vs. Forward Current



- Please refer to the chapter “Precautions for Use”