

THYRISTOR MODULE

PCH10012 PCH10016

100A / 1200 to 1600V

FEATURES

- * Isolated Base
- * Thyristor and Diode Cathode Common
- * High Surge Capability
- * UL Recognized, File No. E187184

OUTLINE DRAWING

TYPICAL APPLICATIONS

- * Rectified For General Use

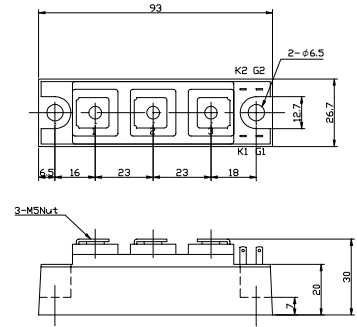
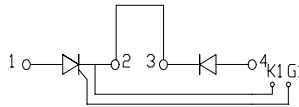

Maximum Ratings

Approx Net Weight:155g

Parameter	Symbol	Grade		Unit
		PCH10012	PCH10016	
Repetitive Peak Off-State Voltage	V_{DRM}	1200	1600	V
Non Repetitive Peak Off-State Voltage	V_{DSM}	1300	1700	V
Repetitive Peak Reverse Voltage	V_{RRM}	1200	1600	V
Non Repetitive Peak Reverse Voltage	V_{RSM}	1300	1700	V

Parameter		Conditions	Max Rated Value	Unit	
Average Rectified Output Current	$I_{O(AV)}$	50Hz Half Sine Wave condition $T_c=77^\circ C$	100	A	
RMS On-State Current	$I_{T(RMS)}$		156	A	
Surge On-State Current	I_{TSM}	50 Hz Half Sine Wave, 1Pulse Non-Repetitive	2000	A	
I Squared t	I^2t	2msec to 10msec	20000	A^2s	
Critical Rate of Turned-On Current	di/dt	$V_D=2/3V_{DRM}$, $I_{TM}=2 \cdot I_o$, $T_j=125^\circ C$ $I_G=200mA$, $di_G/dt=0.2A/\mu s$	100	$A/\mu s$	
Peak Gate Power	P_{GM}		5	W	
Average Gate Power	$P_{G(AV)}$		1	W	
Peak Gate Current	I_{GM}		2	A	
Peak Gate Voltage	V_{GM}		10	V	
Peak Gate Reverse Voltage	V_{RGM}		5	V	
Operating Junction Temperature Range	T_{jw}		-40 to +125	$^\circ C$	
Storage Temperature Range	T_{stg}		-40 to +125	$^\circ C$	
Isolation Voltage	Viso	Base Plate to Terminals, AC1min	2500	V	
Mounting torque	Case mounting	Ftor	M6 Screw	2.4 to 3.5	N.m
	Terminals		M5 Screw	2.4 to 2.8	

Value per 1 Arm

Electrical • Thermal Characteristics

Characteristics	Symbol	Test Conditions	Maximum Value.			Unit
			Min.	Typ.	Max.	
Peak Off-State Current	I_{DM}	$V_{DM} = V_{DRM}, T_j = 125^\circ\text{C}$			20	mA
Peak Reverse Current	I_{RM}	$V_{RM} = V_{RRM}, T_j = 125^\circ\text{C}$			20	mA
Peak Forward Voltage	V_{TM}	$I_{TM} = 300\text{A}, T_j = 25^\circ\text{C}$			1.38	V
Gate Current to Trigger	I_{GT}	$V_D = 6\text{V}, I_T = 1\text{A}$	$T_j = -40^\circ\text{C}$		200	mA
			$T_j = 25^\circ\text{C}$		100	
			$T_j = 125^\circ\text{C}$		50	
Gate Voltage to Trigger	V_{GT}	$V_D = 6\text{V}, I_T = 1\text{A}$	$T_j = -40^\circ\text{C}$		4	V
			$T_j = 25^\circ\text{C}$		2.5	
			$T_j = 125^\circ\text{C}$		2	
Gate Non-Trigger Voltage	V_{GD}	$V_D = 2/3V_{DRM}, T_j = 125^\circ\text{C}$	0.25			V
Critical Rate of Rise of Off-State Voltage	dv/dt	$V_D = 2/3V_{DRM}, T_j = 125^\circ\text{C}$	500			V/ μs
Turn-Off Time	t_q	$I_{TM} = I_o, V_D = 2/3V_{DRM}$ $dv/dt = 20\text{V}/\mu\text{s}, V_R = 100\text{V}$ $-di/dt = 20\text{A}/\mu\text{s}, T_j = 125^\circ\text{C}$		100		μs
Turn-On Time	t_{gt}	$V_D = 2/3V_{DRM}, T_j = 125^\circ\text{C}$ $I_G = 200\text{mA}, di_G/dt = 0.2\text{A}/\mu\text{s}$		6		μs
Delay Time	t_d			2		μs
Rise Time	t_r			4		μs
Latching Current	I_L	$T_j = 25^\circ\text{C}$		100		mA
Holding Current	I_H	$T_j = 25^\circ\text{C}$		50		
Thermal Resistance	$R_{th(j-c)}$	Junction to Case			0.35	$^\circ\text{C}/\text{W}$
	$R_{th(c-f)}$	Base Plate to Heat Sink with Thermal Compound			0.2	

Value Per 1Arm

PCH1001x OUTLINE DRAWING (Dimensions in mm)

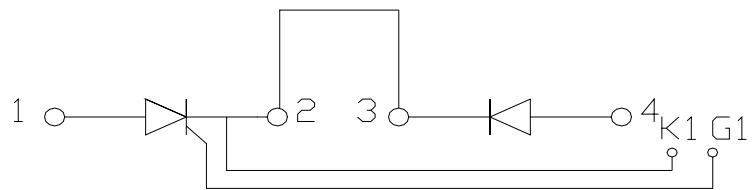
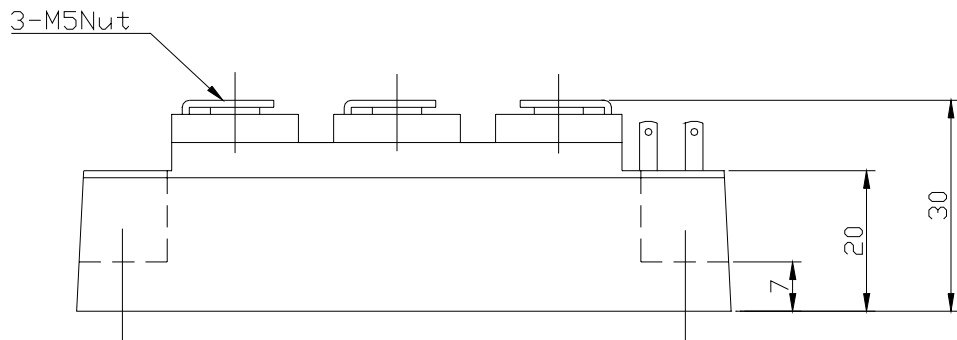
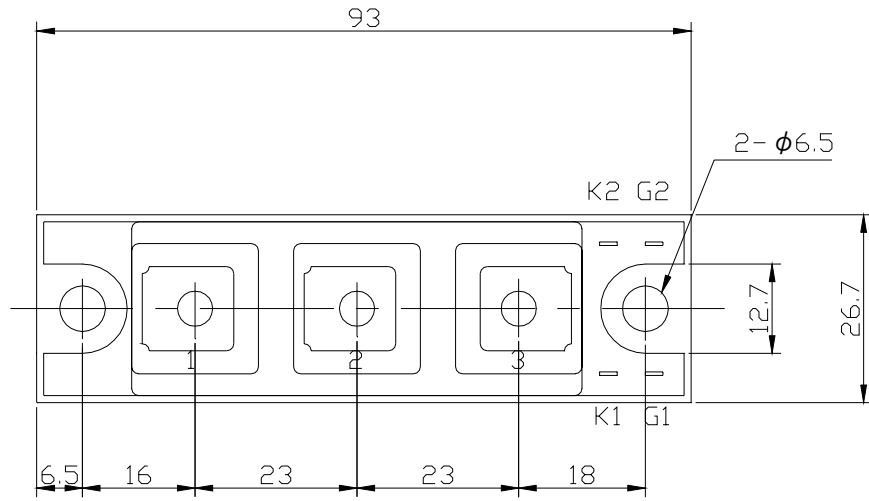

オン電圧特性
ON-STATE CURRENT VS. VOLTAGE

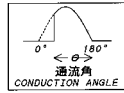
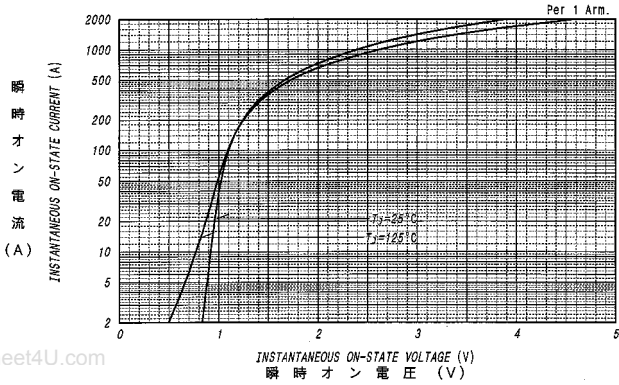

平均オン電力損失特性
AVERAGE ON-STATE POWER DISSIPATION
for SINUSOIDAL CURRENT WAVEFORM

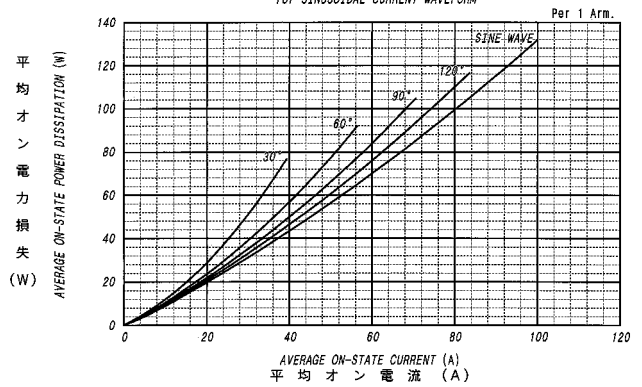

平均オン電力損失 (W)

平均オン電力損失特性
AVERAGE ON-STATE POWER DISSIPATION
for RECTANGULAR CURRENT WAVEFORM

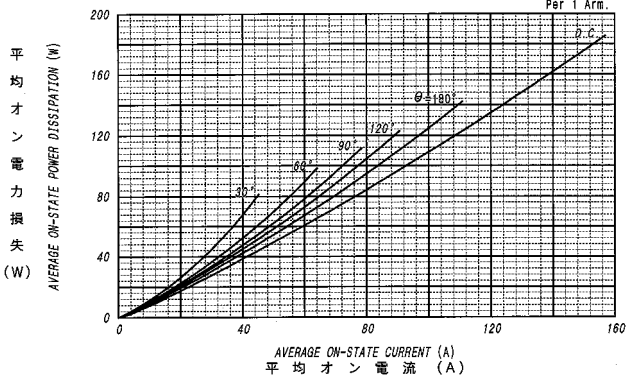

平均オン電力損失 (W)

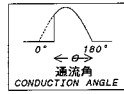

平均オン電流 - ケース温度定格
AVERAGE ON-STATE CURRENT VS. CASE TEMPERATURE
(50Hz SINUSOIDAL CURRENT WAVEFORM)

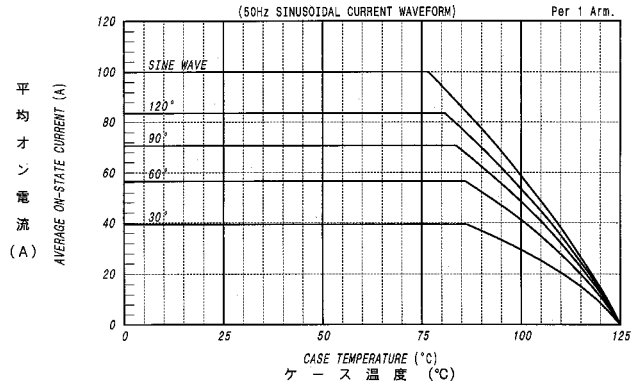

平均オン電流 (A)

平均オン電流 - ケース温度定格
AVERAGE ON-STATE CURRENT VS. CASE TEMPERATURE
(50Hz RECTANGULAR CURRENT WAVEFORM)

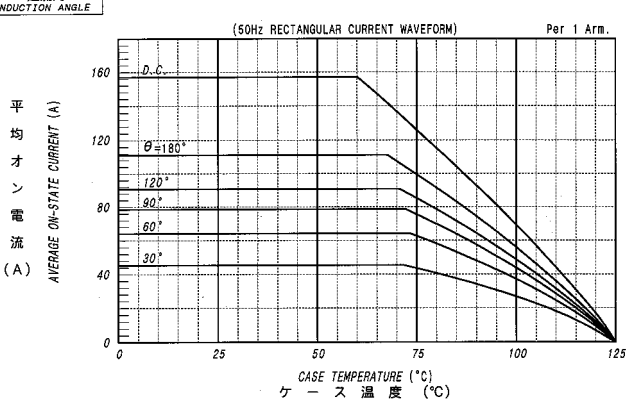

平均オン電流 (A)

サージオン電流定格
SURGE CURRENT RATINGS
 $f=50\text{Hz}$, Half Sine Wave, Non-Repetitive, $T_j=125^\circ\text{C}$

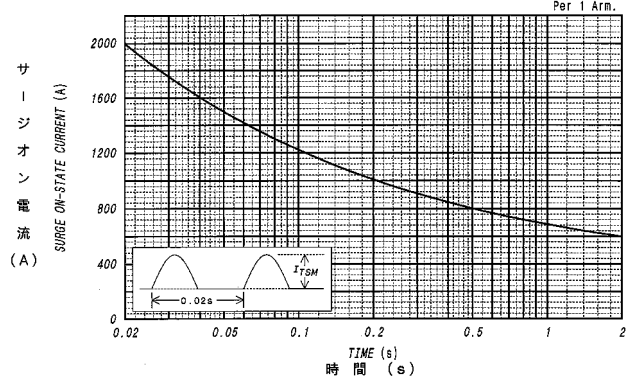

サージオン電流 (A)

ゲート特性
GATE CHARACTERISTICS

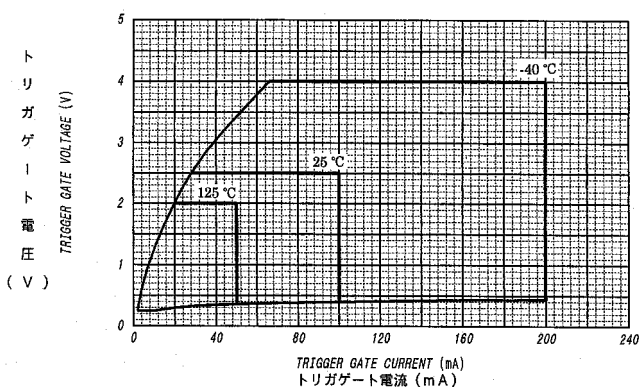

トリガゲート電圧 (V)

ゲート定格
GATE RATINGS

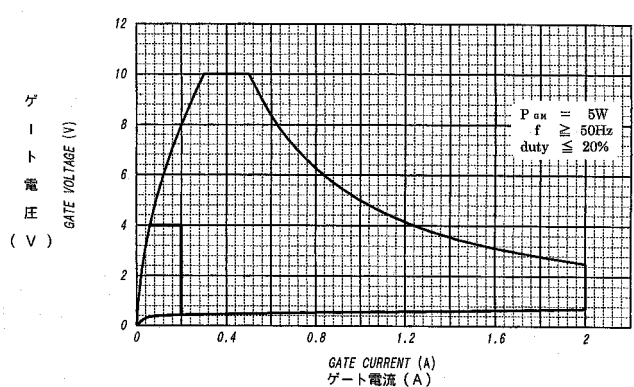

ゲート電圧 (V)

過渡熱抵抗特性
 MAXIMUM TRANSIENT THERMAL IMPEDANCE
 Junction to Case

