

PCS3P73Z01AW

Wide Frequency Range TIMING SAFE™ Peak EMI Reduction IC

Description

PCS3P73Z01AW is a 2.5 V / 3.3 V versatile EMI reduction IC based on ON Semiconductor's patent pending Timing-Safe technology. PCS3P73Z01AW accepts one input from an external reference, and locks on to it delivering a 1x Timing-Safe clock. PCS3P73Z01AW has a Frequency Selection (FS) control that facilitates selecting one of the two frequency ranges within the operating frequency range. Refer to the *Frequency Selection Table* for details. The device has an SSEXTR pin to select different deviation and associated Input-Output Skew (T_{SKEW}), depending upon the value of an external resistor connected between SSEXTR and GND. PCS3P73Z01AW has a DLY_CTRL for adjusting the Input-Output clock delay, depending upon the value of capacitor connected at this pin to GND. PD#/OE provides the Power Down option. Outputs will be tri-stated when power down is active.

PCS3P73Z01AW operates from a 2.5 V / 3.3 V supply and is available in an 8 Pin, TSSOP, and TDFN (2X2) COL Packages, over Commercial and Industrial temperature range.

Application

PCS3P73Z01AW is targeted for use in Displays, Camera modules and SDRAM memory interface systems.

Features

- 1x, LVCMOS Timing-Safe Peak EMI Reduction
- Input Frequency:
 - 2 MHz – 16 MHz @ 2.5 V
 - 2 MHz – 20 MHz @ 3.3 V
- Output Frequency (Timing-Safe):
 - 2 MHz – 16 MHz @ 2.5 V
 - 2 MHz – 20 MHz @ 3.3 V
- Analog Deviation Selection
- External Input-Output Delay Control Option
- Power Down Option for Power Save Mode
- Supply Voltage:
 - 2.5 V \pm 0.2 V
 - 3.3 V \pm 0.3 V
- Commercial and Industrial Temperature Range
- 8 pin, TSSOP, and TDFN(2X2) COL Packages
- The First True Drop-in Solution
- These Devices are Pb-Free, Halogen Free/BFR Free and are RoHS Compliant



ON Semiconductor®

<http://onsemi.com>

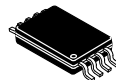

TSSOP-8
T SUFFIX
CASE 948AL



TDFN-8
C SUFFIX
CASE 511AQ

PIN CONFIGURATION

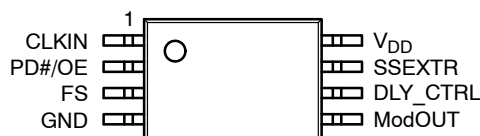

ORDERING INFORMATION

See detailed ordering and shipping information in the package dimensions section on page 13 of this data sheet.

PCS3P73Z01AW

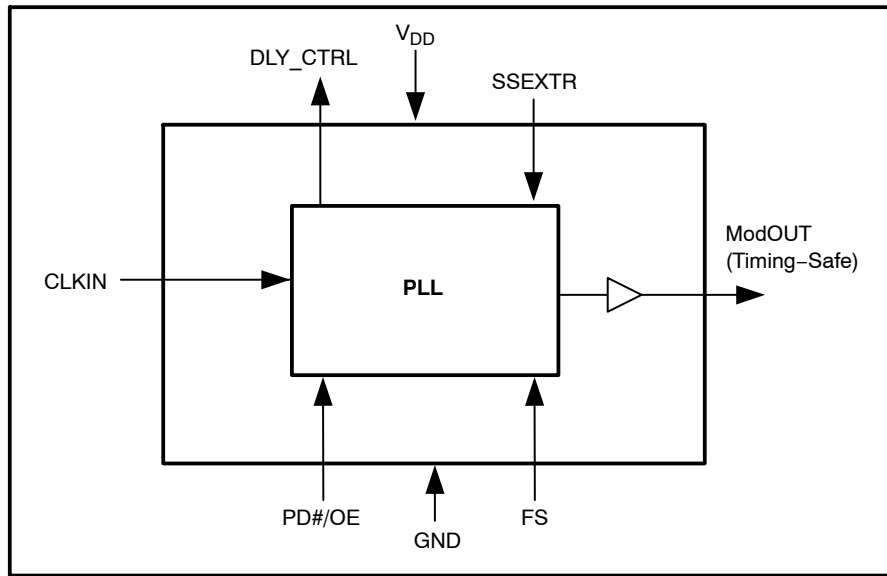

Figure 1. Block Diagram

Table 1. PIN DESCRIPTION

Pin #	Type	Pin Name	Description
1	I	CLKIN	External reference Clock input.
2	I	PD#/OE	Power Down. Pull LOW to enable Power Down. Outputs will be tri-stated when power down is enabled. Pull HIGH to disable power down and enable output. There is NO default state.
3	I	FS	Frequency Select. There is NO default state. <i>See Frequency Selection table for details.</i>
4	P	GND	Ground
5	O	ModOUT	Buffered modulated Timing-Safe clock output
6	O	DLY_CTRL	External Input-Output Delay control
7	I	SSEXTR	Analog Deviation Selection through external resistor to GND.
8	P	V _{DD}	2.5 V / 3.3 V supply Voltage

Table 2. FREQUENCY SELECTION TABLE

V _{DD}	FS	Frequency (MHz)
2.5 V	0	2-6
	1	6-16
3.3 V	0	2-6
	1	6-20

Table 3. OPERATING CONDITIONS

Parameter	Description	Min	Max	Unit	
V _{DD} (3.3 V)	Supply Voltage	2.3	2.7	V	
V _{DD} (2.5 V)	Supply Voltage	3	3.6	V	
T _A	Operating Temperature	Commercial	0	+70	°C
		Industrial	-40	+85	
C _L	Load Capacitance		10	pF	
C _{IN}	Input Capacitance		7	pF	

PCS3P73Z01AW

Table 4. ABSOLUTE MAXIMUM RATING

Symbol	Parameter	Rating	Unit
V_{DD}, V_{IN}	Voltage on any input pin with respect to Ground	-0.5 to +4.6	V
T_{STG}	Storage temperature	-65 to +125	°C
T_s	Max. Soldering Temperature (10 sec)	260	°C
T_J	Junction Temperature	150	°C
T_{DV}	Static Discharge Voltage (As per JEDEC STD22- A114-B)	2	KV

Stresses exceeding Maximum Ratings may damage the device. Maximum Ratings are stress ratings only. Functional operation above the Recommended Operating Conditions is not implied. Extended exposure to stresses above the Recommended Operating Conditions may affect device reliability.

Table 5. ELECTRICAL CHARACTERISTICS FOR 2.5 V SUPPLY

Parameter	Description	Test Conditions	Min	Typ	Max	Unit
V_{DD}	Supply Voltage		2.3	2.5	2.7	V
V_{IL}	Input LOW Voltage				0.7	V
V_{IH}	Input HIGH Voltage		1.7			V
I_{IL}	Input LOW Current	$V_{IN} = 0\text{ V}$			50	μA
I_{IH}	Input HIGH Current	$V_{IN} = V_{DD}$			50	μA
V_{OL}	Output LOW Voltage	$I_{OL} = 8\text{ mA}$			0.6	V
V_{OH}	Output HIGH Voltage	$I_{OH} = -8\text{ mA}$	1.8			V
I_{CC}	Static Supply Current	CLKIN & PD#/OE pins pulled to GND			2	μA
I_{DD}	Dynamic Supply Current (Unloaded Output)	Commercial temp.	FS = 0		6	mA
			FS = 1		7	
		Industrial temp.	FS = 0		8	
			FS = 1		9	
Z_o	Output Impedance		36		Ω	

Table 6. SWITCHING CHARACTERISTICS FOR 2.5 V

Parameter	Test Conditions	Min	Typ	Max	Unit
Input Frequency	FS = 0	2		6	MHz
	FS = 1	6		16	
ModOUT	FS = 0	2		6	MHz
	FS = 1	6		16	
Duty Cycle (Notes 1, 2)	Measured at $V_{DD}/2$	45	50	55	%
Rise Time (Notes 1, 2)	Measured between 20% to 80%		1.7	2.3	nS
Fall Time (Notes 1, 2)	Measured between 80% to 20%		0.9	1.6	nS
Cycle-to-Cycle Jitter (Note 2)	Unloaded output with SSEXTR OPEN	FS = 0; @ 5 MHz		± 225	pS
		FS = 1; @ 15 MHz		± 150	
Input-to-Output propagation Delay (Note 2)	Unloaded outputs with SSEXTR pin OPEN, No load on DLY_CTRL	FS = 0; @ 6 MHz		175	pS
		FS = 1; @ 12 MHz		75	
PLL Lock Time (Note 2)	Stable power supply, valid clock presented on CLKIN pin			3	mS

1. All parameters are specified with 10 pF loaded outputs.
2. Parameter is guaranteed by design and characterization. Not 100% tested in production.

PCS3P73Z01AW

Table 7. ELECTRICAL CHARACTERISTICS FOR 3.3 V SUPPLY

Parameter	Description	Test Conditions		Min	Typ	Max	Unit
V _{DD}	Supply Voltage			3.0	3.3	3.6	V
V _{IH}	Input HIGH Voltage			2.0			V
V _{IL}	Input LOW Voltage					0.8	V
I _{IH}	Input HIGH Current	V _{IN} = V _{DD}				50	μA
I _{IL}	Input LOW Current	V _{IN} = 0 V				50	μA
V _{OH}	Output HIGH Voltage	I _{OH} = -8 mA		2.4			V
V _{OL}	Output LOW Voltage	I _{OL} = 8 mA				0.4	V
I _{CC}	Static Supply Current	CLKIN pulled Low, PD#/OE pulled Low				2	μA
I _{DD}	Dynamic Supply Current (Unloaded output)	Commercial temp.	FS = 0			8	mA
			FS = 1			10	
		Industrial temp.	FS = 0			10	
			FS = 1			12	
Z _o	Output Impedance				27		Ω

Table 8. SWITCHING CHARACTERISTICS FOR 3.3 V

Parameter	Test Conditions		Min	Typ	Max	Unit
Input Frequency	FS = 0		2		6	MHz
	FS = 1		6		20	
ModOUT	FS = 0		2		6	
	FS = 1		6		20	
Duty Cycle (Notes 3, 4)	Measured at V _{DD} /2		45	50	55	%
Rise Time (Notes 3, 4)	Measured between 20% to 80%			1.2	1.9	nS
Fall Time (Notes 3, 4)	Measured between 80% to 20%			0.8	1.4	nS
Cycle-to-Cycle Jitter (Note 4)	Unloaded output with SSEXTR OPEN	FS = 0; @ 5 MHz		±200		pS
		FS = 1; @ 15 MHz		±125		
Input-to-Output propagation Delay (Note 4)	Unloaded outputs with SSEXTR pin OPEN, No load on DLY_CTRL	FS = 0; @ 6 MHz		-75		pS
		FS = 1; @ 12 MHz		125		
PLL Lock Time (Note 4)	Stable power supply, valid clock presented on CLKIN pin				3	mS

3. All parameters are specified with 10 pF loaded outputs.

4. Parameter is guaranteed by design and characterization. Not 100% tested in production.

PCS3P73Z01AW

Switching Waveforms

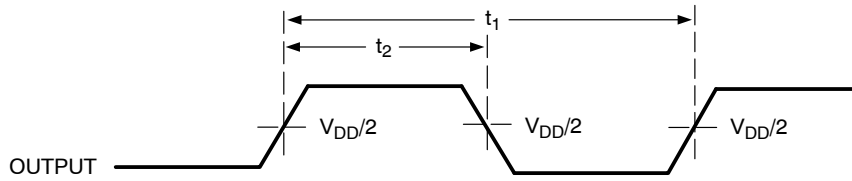

Figure 2. Duty Cycle Timing

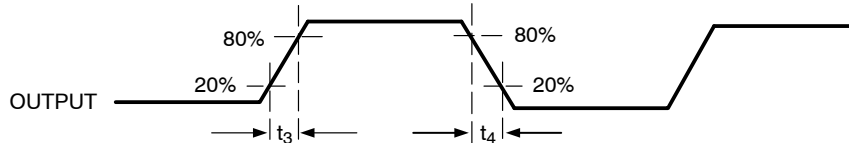

Figure 3. All Outputs Rise/Fall Time

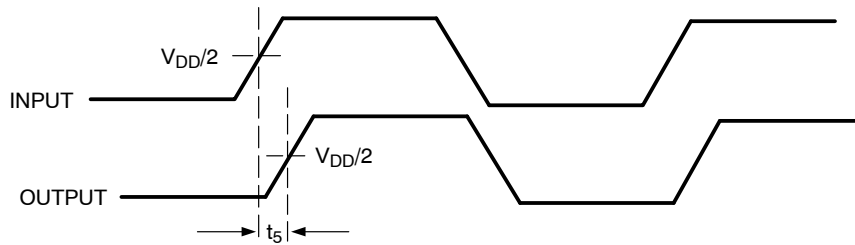
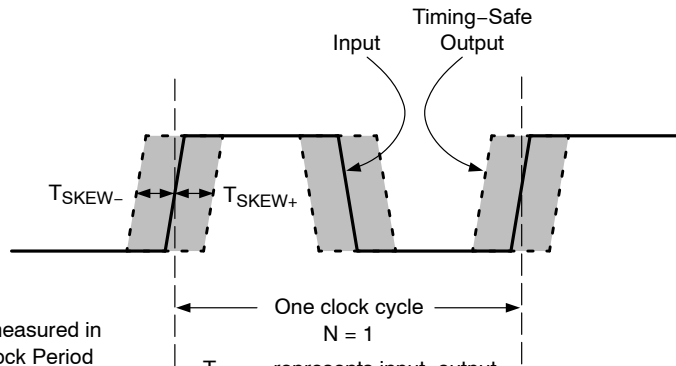

Figure 4. Input - Output Propagation Delay



NOTE: Tskew is measured in units of Clock Period

T_{SKREW} represents input-output skew when Deviation is ON
 For example, T_{SKREW} = ± 0.20 for an Input clock of 12 MHz, translates in to (1/12 MHz) * 0.20 = 16.66 nS

Figure 5. Input - Output Skew

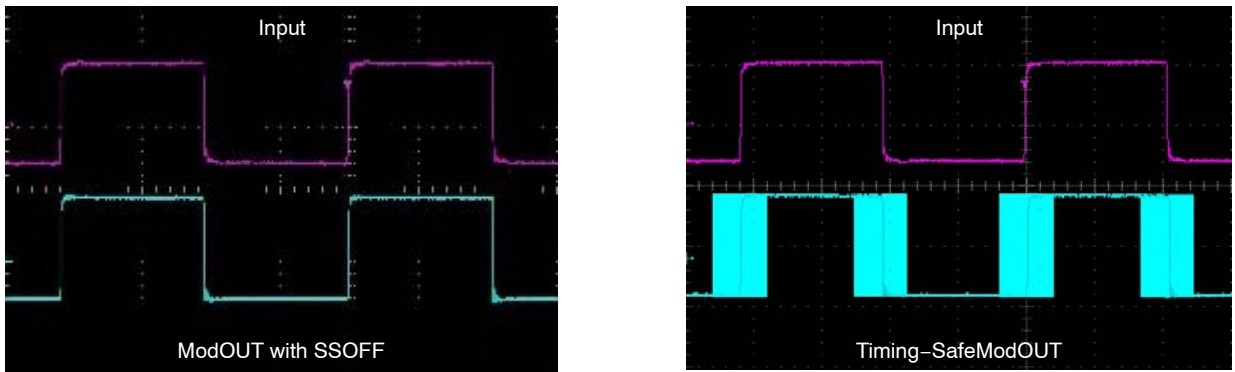

Figure 6. Typical Example of Timing-Safe Waveform

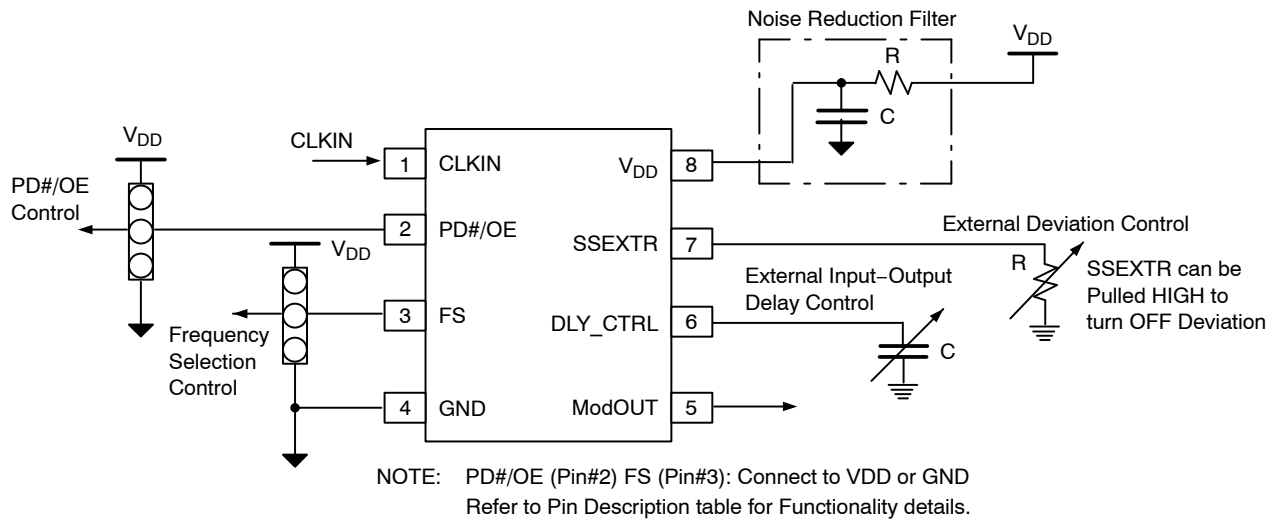

Figure 7. Typical Application Schematic

PCS3P73Z01AW

TYPICAL CHARACTERISTICS (for $V_{DD} = 2.5\text{ V} \pm 0.2\text{ V}$ and $3.3\text{ V} \pm 0.3\text{ V}$)

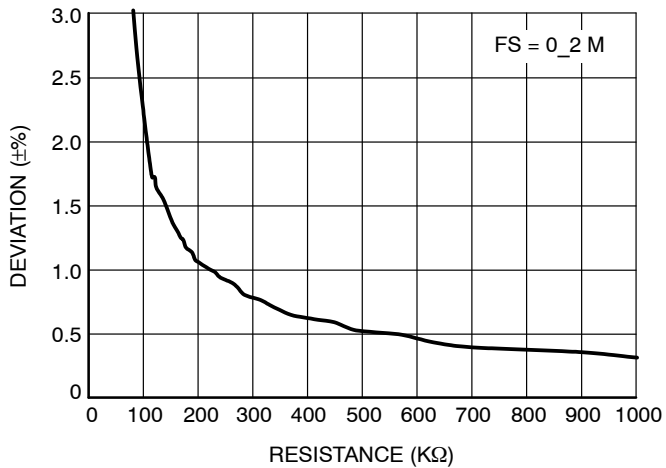

Figure 8. Deviation vs. Resistance
(2 MHz, FS = 0)

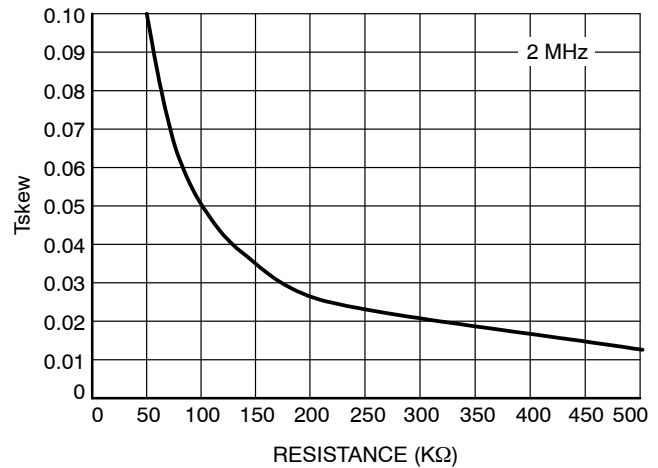

Figure 9. Tskew vs. Resistance
(2 MHz, FS = 0)

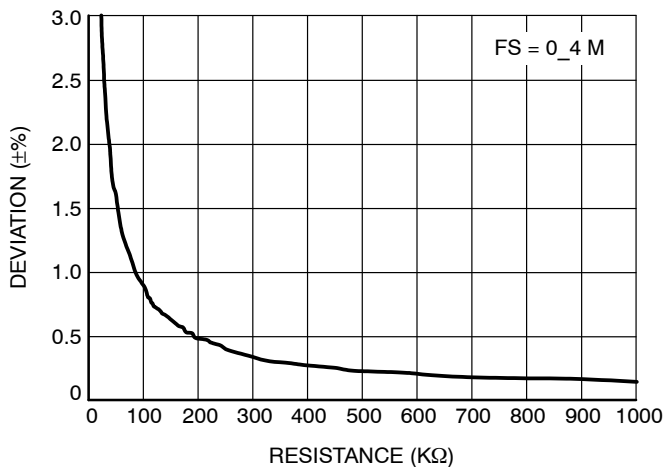

Figure 10. Deviation vs. Resistance
(4 MHz, FS = 0)

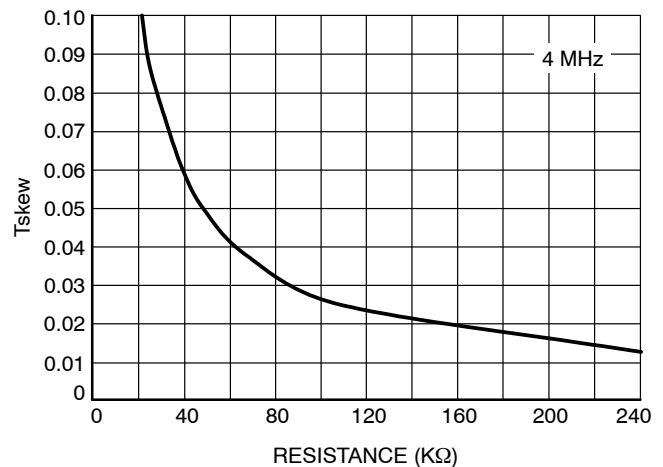

Figure 11. Tskew vs. Resistance
(4 MHz, FS = 0)

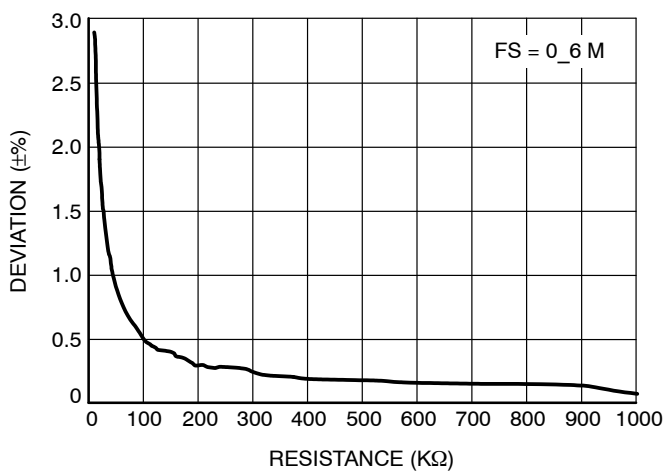

Figure 12. Deviation vs. Resistance
(6 MHz, FS = 0)

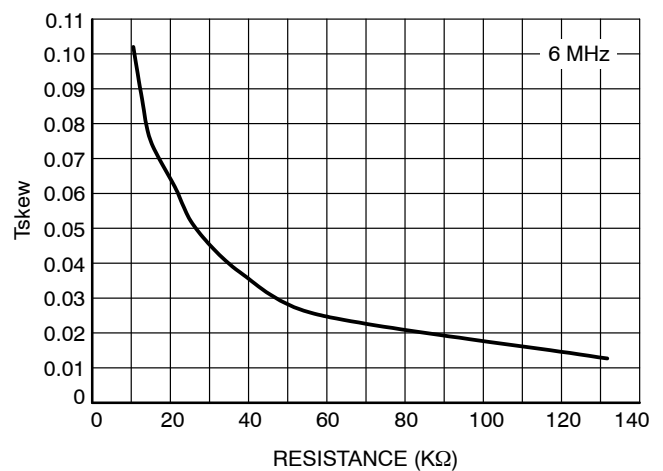

Figure 13. Tskew vs. Resistance
(6 MHz, FS = 0)

PCS3P73Z01AW

TYPICAL CHARACTERISTICS (for $V_{DD} = 2.5\text{ V} \pm 0.2\text{ V}$ and $3.3\text{ V} \pm 0.3\text{ V}$)

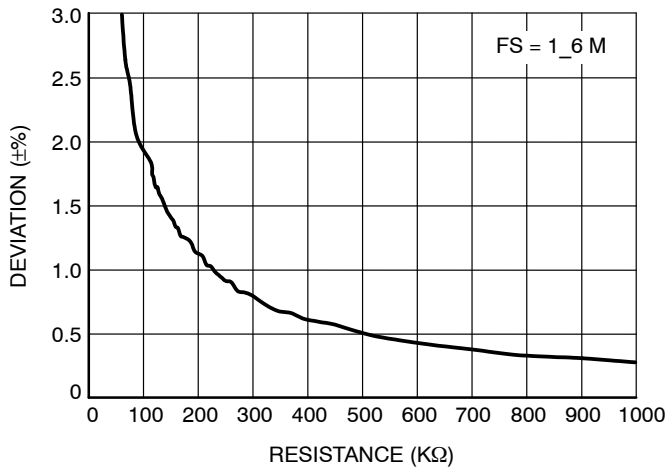

Figure 14. Deviation vs. Resistance
(6 MHz, FS = 1)

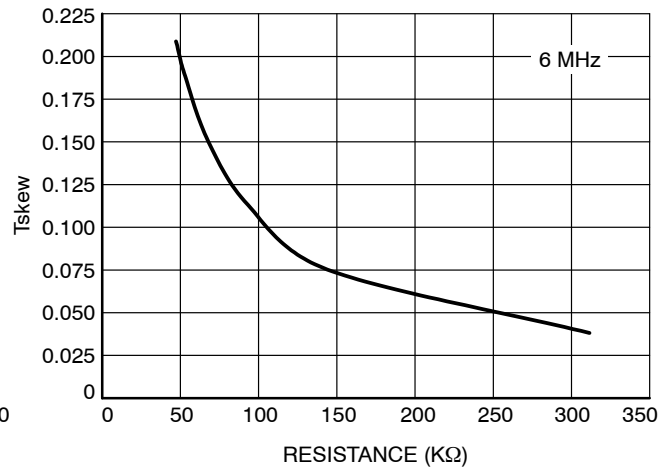

Figure 15. Tskew vs. Resistance
(6 MHz, FS = 1)

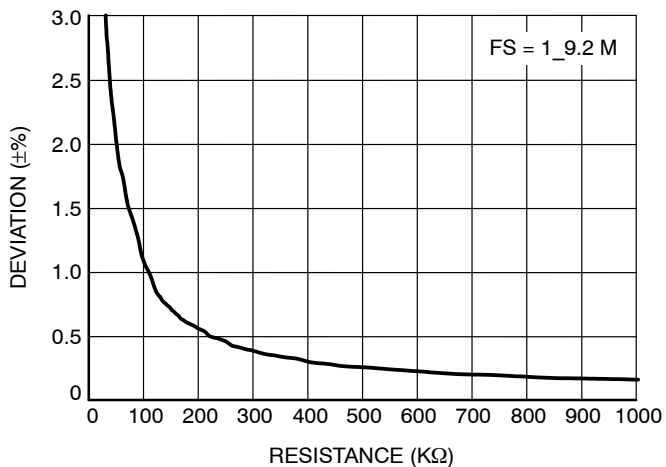

Figure 16. Deviation vs. Resistance
(9.2 MHz, FS = 1)

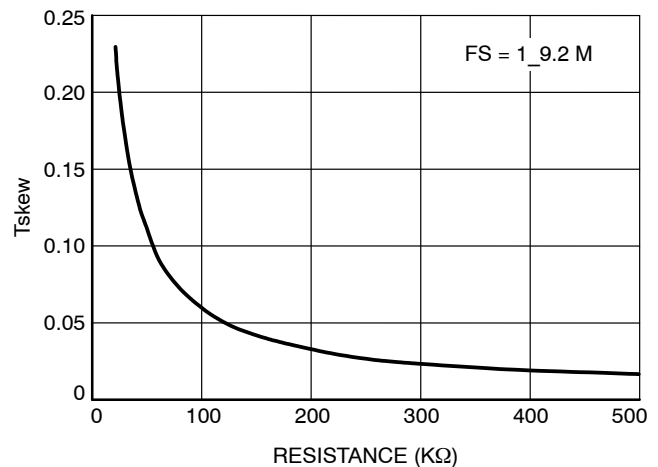

Figure 17. Tskew vs. Resistance
(9.2 MHz, FS = 1)

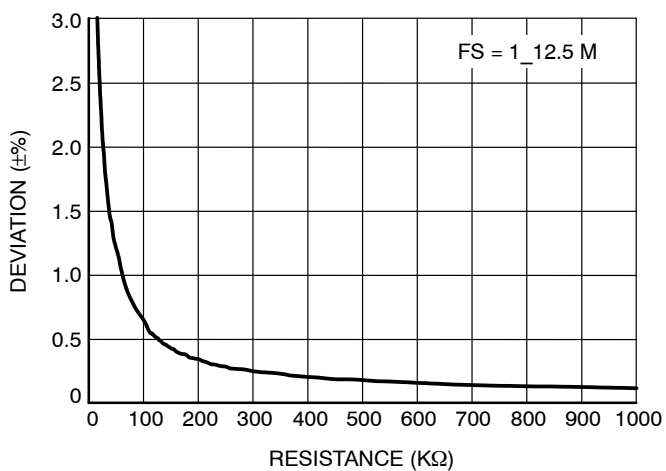

Figure 18. Deviation vs. Resistance
(12.5 MHz, FS = 1)

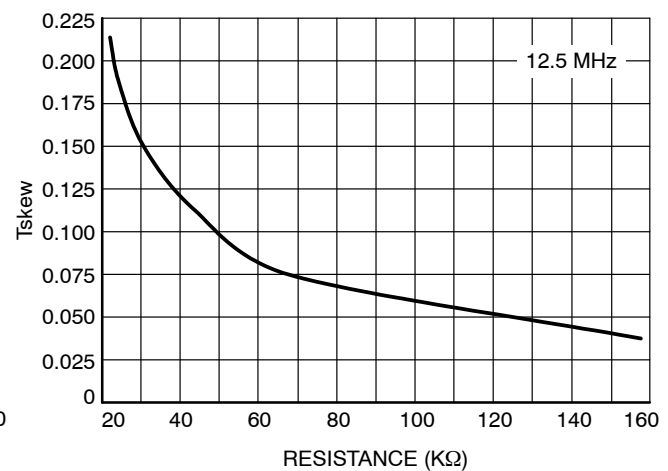

Figure 19. Tskew vs. Resistance
(12.5 MHz, FS = 1)

PCS3P73Z01AW

TYPICAL CHARACTERISTICS (for $V_{DD} = 2.5\text{ V} \pm 0.2\text{ V}$ and $3.3\text{ V} \pm 0.3\text{ V}$)

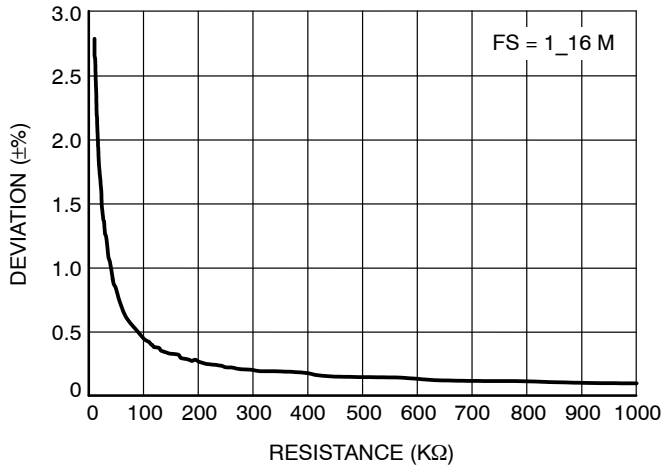

Figure 20. Deviation vs. Resistance (16 MHz, FS = 1)

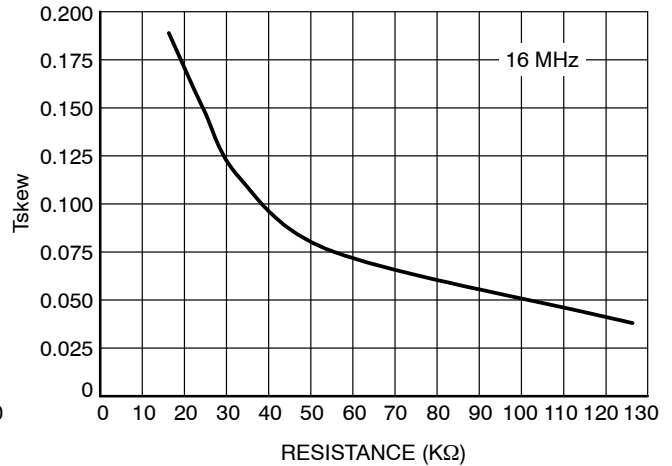

Figure 21. Tskew vs. Resistance (16 MHz, FS = 1)

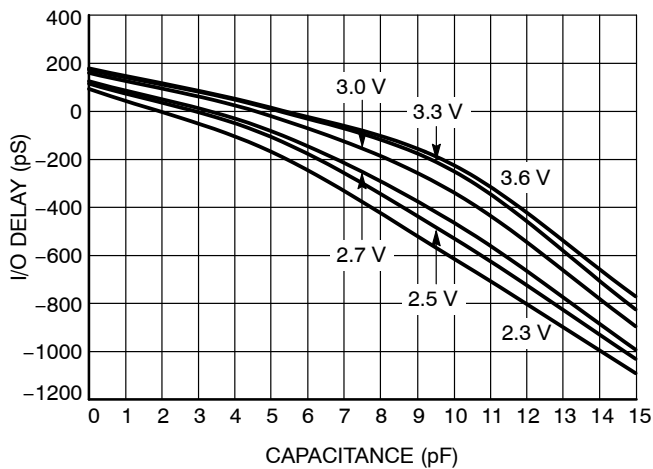

Figure 22. I/O Delay vs. Load (DLY_CTRL) (For 2 MHz, FS = 0)

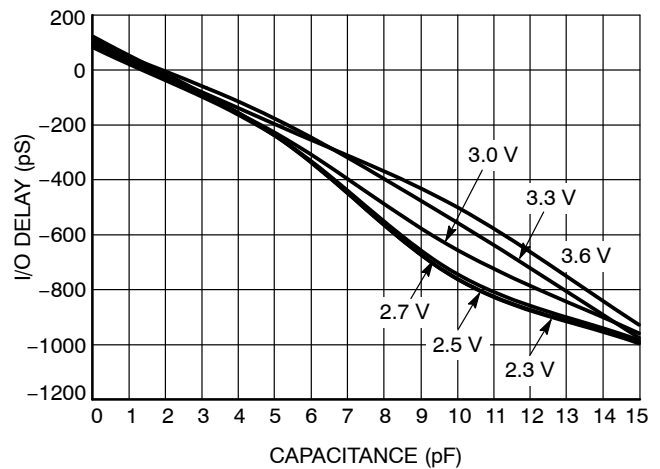

Figure 23. I/O Delay vs. Load (DLY_CTRL) (For 4 MHz, FS = 0)

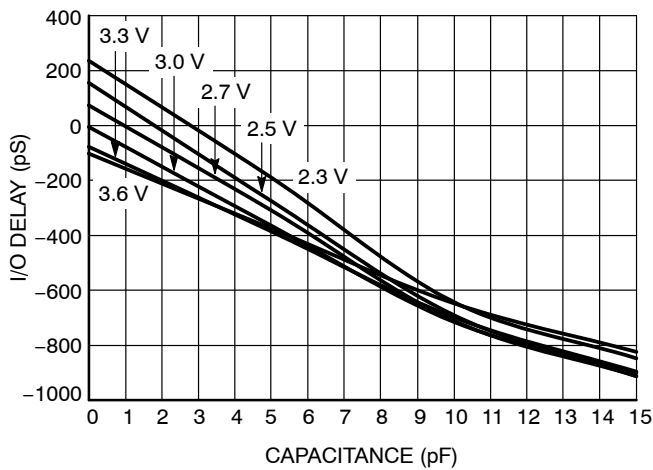

Figure 24. I/O Delay vs. Load (DLY_CTRL) (For 6 MHz, FS = 0)

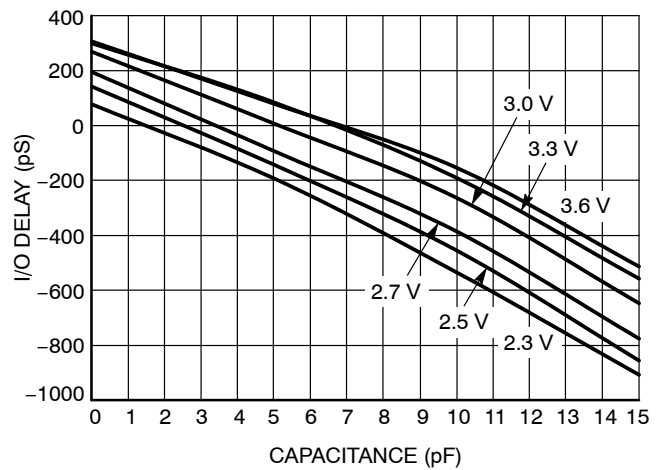

Figure 25. I/O Delay vs. Load (DLY_CTRL) (For 6 MHz, FS = 1)

PCS3P73Z01AW

TYPICAL CHARACTERISTICS (for $V_{DD} = 2.5\text{ V} \pm 0.2\text{ V}$ and $3.3\text{ V} \pm 0.3\text{ V}$)

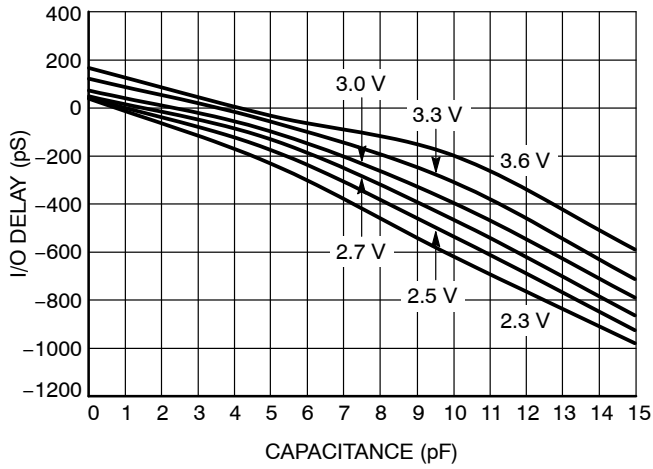

Figure 26. I/O Delay vs. Load (DLY_CTRL)
(For 12.5 MHz, FS = 1)

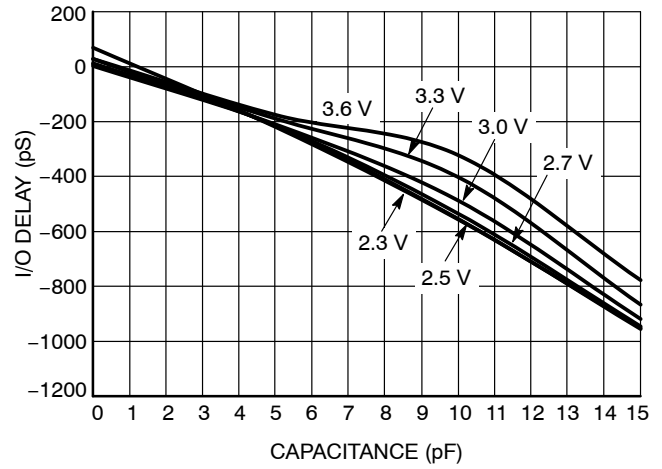
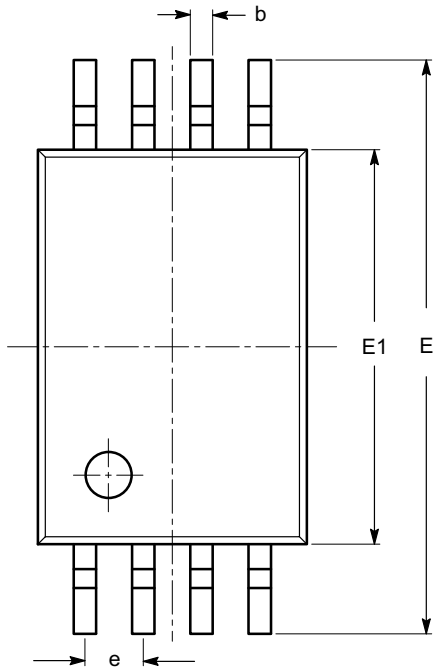

Figure 27. I/O Delay vs. Load (DLY_CTRL)
(For 16 MHz, FS = 1)

PCS3P73Z01AW

PACKAGE DIMENSIONS

TSSOP8, 4.4x3
CASE 948AL-01
ISSUE O



SYMBOL	MIN	NOM	MAX
A			1.20
A1	0.05		0.15
A2	0.80	0.90	1.05
b	0.19		0.30
c	0.09		0.20
D	2.90	3.00	3.10
E	6.30	6.40	6.50
E1	4.30	4.40	4.50
e	0.65 BSC		
L	1.00 REF		
L1	0.50	0.60	0.75
θ	0°		8°

TOP VIEW

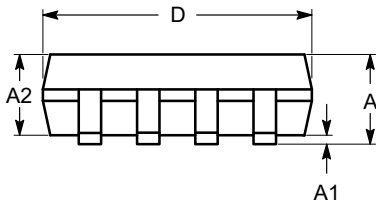

SIDE VIEW

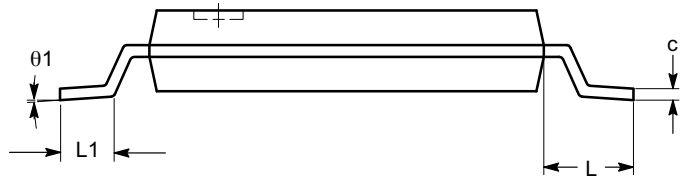

END VIEW

Notes:

- (1) All dimensions are in millimeters. Angles in degrees.
- (2) Complies with JEDEC MO-153.

PCS3P73Z01AW

PACKAGE DIMENSIONS

WDFN8 2x2, 0.5P
CASE 511AQ-01
ISSUE A

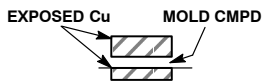
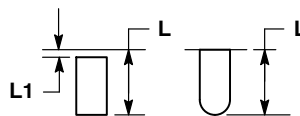
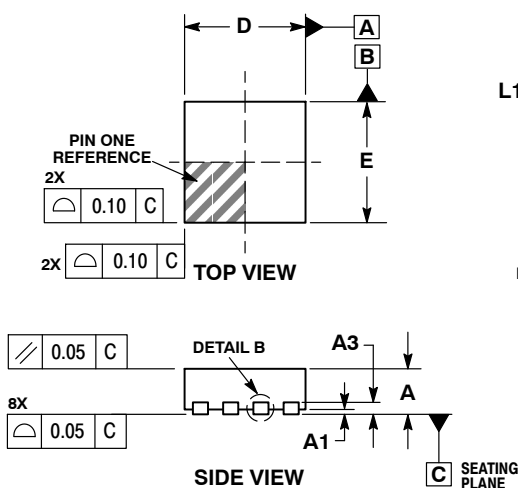

- NOTES:
1. DIMENSIONING AND TOLERANCING PER ASME Y14.5M, 1994.
 2. CONTROLLING DIMENSION: MILLIMETERS.
 3. DIMENSION b APPLIES TO PLATED TERMINAL AND IS MEASURED BETWEEN 0.15 AND 0.30mm FROM TERMINAL.

DIM	MILLIMETERS	
	MIN	MAX
A	0.70	0.80
A1	0.00	0.05
A3	0.20 REF	
b	0.20	0.30
D	2.00 BSC	
E	2.00 BSC	
e	0.50 BSC	
L	0.50	0.60
L1	---	0.15

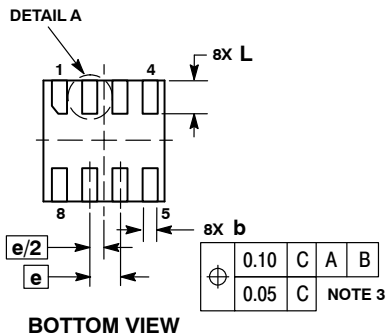

RECOMMENDED SOLDERING FOOTPRINT*

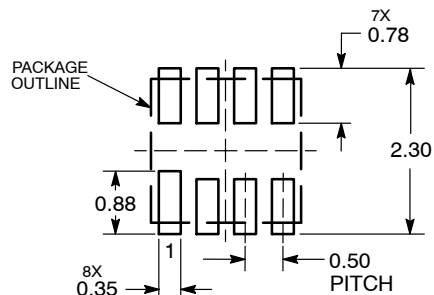

DIMENSIONS: MILLIMETERS

*For additional information on our Pb-Free strategy and soldering details, please download the ON Semiconductor Soldering and Mounting Techniques Reference Manual, SOLDERRM/D.

PCS3P73Z01AW

Table 9. ORDERING INFORMATION

Ordering Code	Marking	Package Type	Temperature
PCS3P73Z01AWG-08-TT	3P73Z01AWG	8-pin 4.4-mm TSSOP – TUBE, Green	Commercial
PCS3P73Z01AWG-08-TR	3P73Z01AWG	8-pin 4.4-mm TSSOP – TAPE & REEL, Green	Commercial
PCS3P73Z01AWG-08-CR	AE1 LLYW	8-pin 2-mm TDFN COL – TAPE & REEL, Green	Commercial
PCS3I73Z01AWG-08-TT	3I73Z01AWG	8-pin 4.4-mm TSSOP – TUBE, Green	Industrial
PCS3I73Z01AWG-08-TR	3I73Z01AWG	8-pin 4.4-mm TSSOP – TAPE & REEL, Green	Industrial
PCS3I73Z01AWG-08-CR	AE2 LLYW	8-pin 2-mm TDFN COL – TAPE & REEL, Green	Industrial

TIMING SAFE is a trademark of Semiconductor Components Industries, LLC.

ON Semiconductor and  are registered trademarks of Semiconductor Components Industries, LLC (SCILLC). SCILLC reserves the right to make changes without further notice to any products herein. SCILLC makes no warranty, representation or guarantee regarding the suitability of its products for any particular purpose, nor does SCILLC assume any liability arising out of the application or use of any product or circuit, and specifically disclaims any and all liability, including without limitation special, consequential or incidental damages. "Typical" parameters which may be provided in SCILLC data sheets and/or specifications can and do vary in different applications and actual performance may vary over time. All operating parameters, including "Typicals" must be validated for each customer application by customer's technical experts. SCILLC does not convey any license under its patent rights nor the rights of others. SCILLC products are not designed, intended, or authorized for use as components in systems intended for surgical implant into the body, or other applications intended to support or sustain life, or for any other application in which the failure of the SCILLC product could create a situation where personal injury or death may occur. Should Buyer purchase or use SCILLC products for any such unintended or unauthorized application, Buyer shall indemnify and hold SCILLC and its officers, employees, subsidiaries, affiliates, and distributors harmless against all claims, costs, damages, and expenses, and reasonable attorney fees arising out of, directly or indirectly, any claim of personal injury or death associated with such unintended or unauthorized use, even if such claim alleges that SCILLC was negligent regarding the design or manufacture of the part. SCILLC is an Equal Opportunity/Affirmative Action Employer. This literature is subject to all applicable copyright laws and is not for resale in any manner.

PUBLICATION ORDERING INFORMATION

LITERATURE FULFILLMENT:

Literature Distribution Center for ON Semiconductor
P.O. Box 5163, Denver, Colorado 80217 USA
Phone: 303-675-2175 or 800-344-3860 Toll Free USA/Canada
Fax: 303-675-2176 or 800-344-3867 Toll Free USA/Canada
Email: orderlit@onsemi.com

N. American Technical Support: 800-282-9855 Toll Free
USA/Canada
Europe, Middle East and Africa Technical Support:
Phone: 421 33 790 2910
Japan Customer Focus Center
Phone: 81-3-5773-3850

ON Semiconductor Website: www.onsemi.com

Order Literature: <http://www.onsemi.com/orderlit>

For additional information, please contact your local Sales Representative