

Data Sheet

PD0900U06-150

Power Divider/Combiner

4-Way 0° 50Ω 820-960 MHz

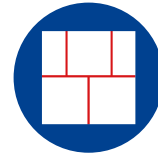

Yantel
Key Patents Lead Microwave Tech

Features

- Small Size (3×3mm QFN package)
- No need external 100 Ω resistor
- Very Low Loss
- Tight Amplitude Balance
- High Isolation
- Low VSWR
- Good Repeatability
- Tape & Reel
- Operating Temperature -40 ~85
- Power handling
 - 2 Watts as a divider
 - 0.5 Watts as a combiner

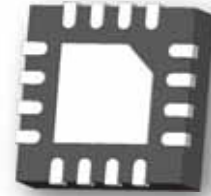

Applications

- Wireless communications
- WLAN / WiMax
- SAT Radio
- ISM band instrument
- Information System for Automotive Safety

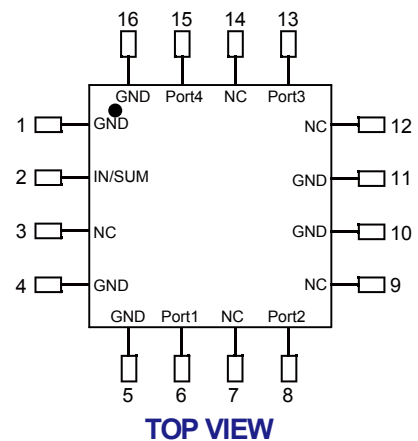

Electrical Specifications at 25° C

Parameter	Symbol	Min	Typ	Max	Unit
Frequency Range	F	820		960	MHz
Insertion Loss (Above 6dB)	I_L		0.8		dB
Isolation	Isol		22		dB
Phase balance	\varnothing_{bal}		±1.5		deg
Amplitude balance	A_{bal}		±0.2		dB
Input VSWR			1.3		:1
Output VSWR			1.2		:1

Yantel Corporation

Add : 3F, Building 3, Southern District 2 of Zhongguan Honghualing Industrial Park, Xili, Nanshan, Shenzhen, China

Tel : 86-755-8355-1886 Fax : 86-755-8355-2533

For detailed performance specs & shopping online see Yantel web site : www.yantel-corp.com

Data Sheet

PD0900U06-150

Power Divider/Combiner
4-Way 0° 50Ω 820-960 MHz

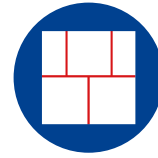

Yantel
Key Patents Lead Microwave Tech

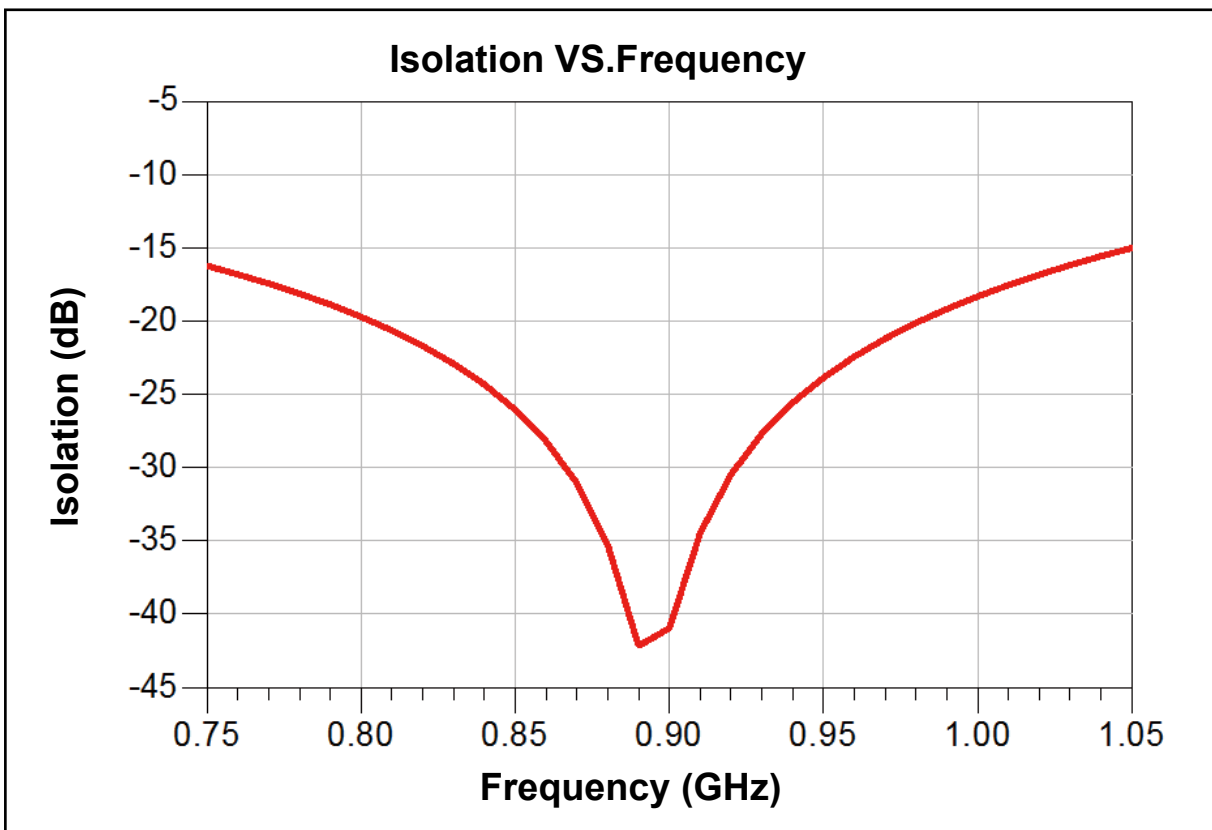
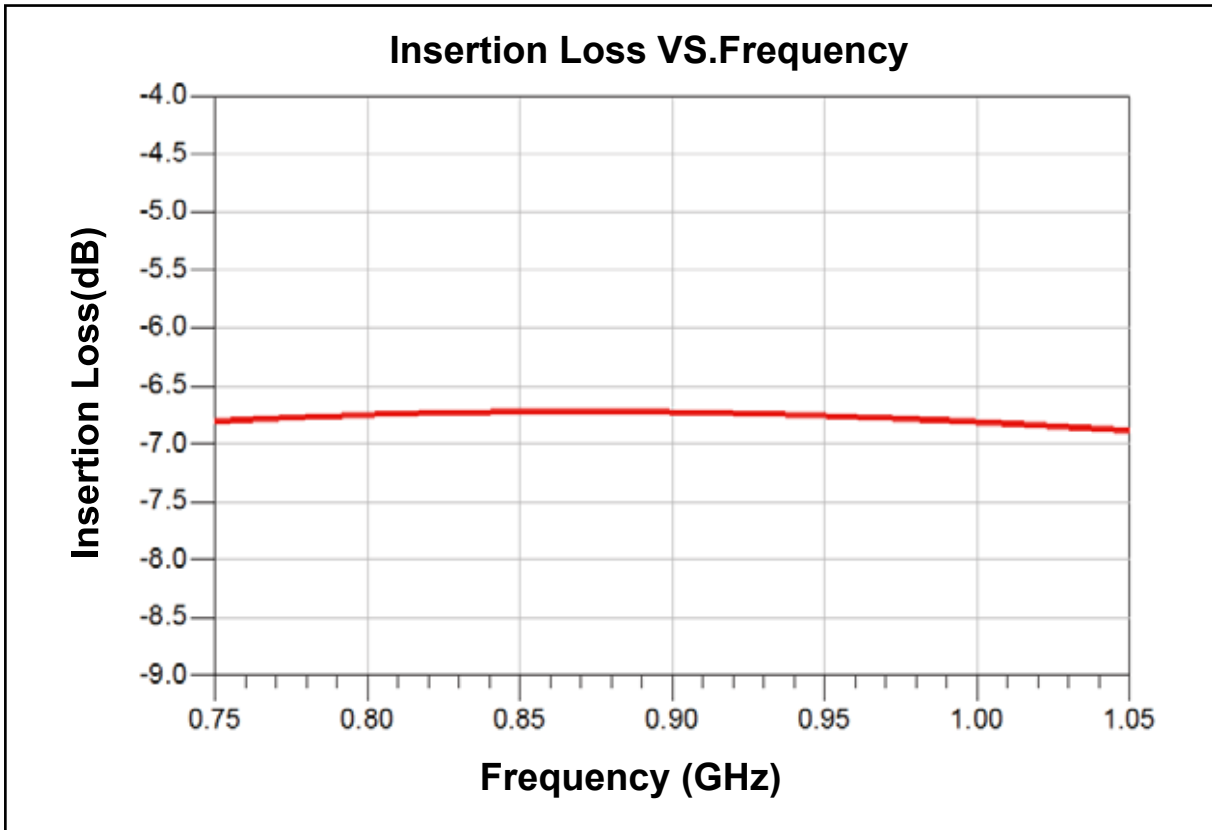

Yantel Corporation

Add : 3F, Building 3, Southern District 2 of Zhongguan Honghualing Industrial Park, Xili, Nanshan, Shenzhen, China

Tel : 86-755-8355-1886 Fax : 86-755-8355-2533

For detailed performance specs & shopping online see Yantel web site : www.yantel-corp.com

Data Sheet

PD0900U06-150

Power Divider/Combiner
4-Way 0° 50Ω 820-960 MHz

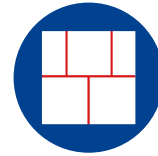

Yantel
Key Patents Lead Microwave Tech

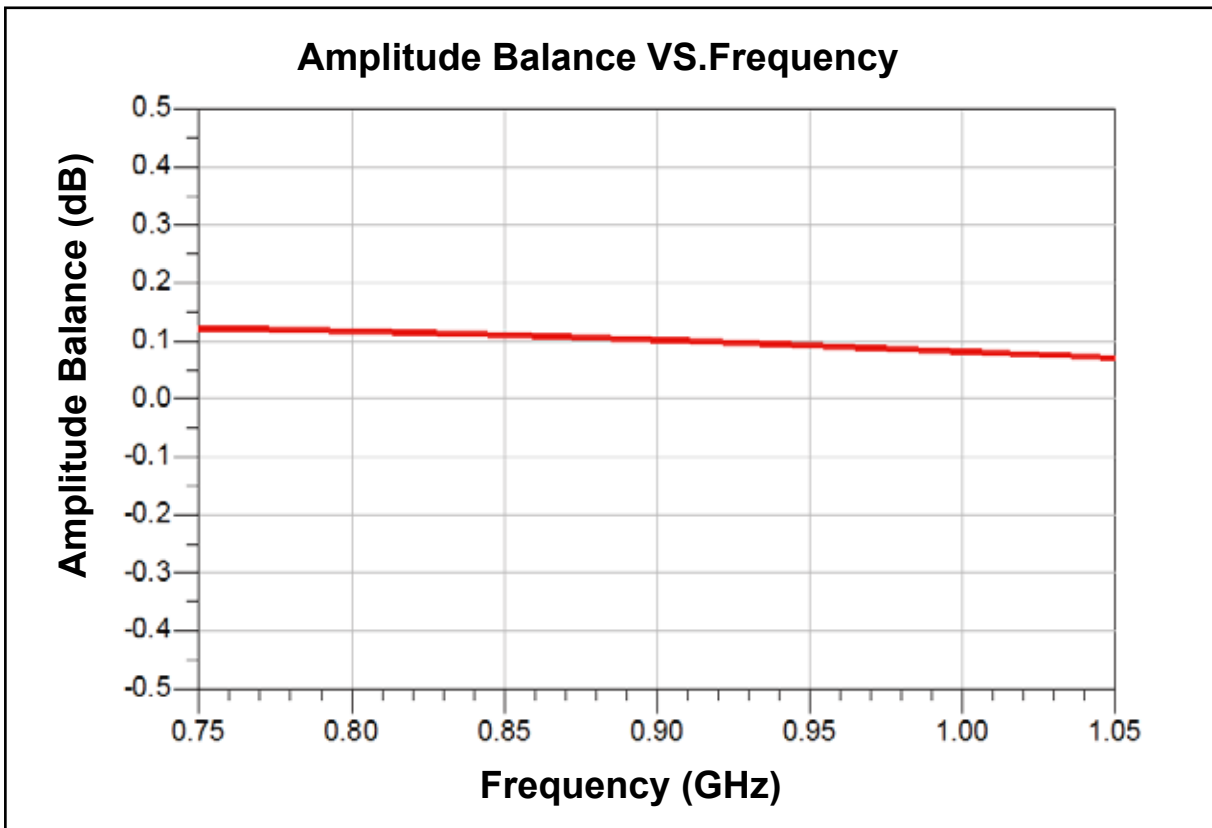
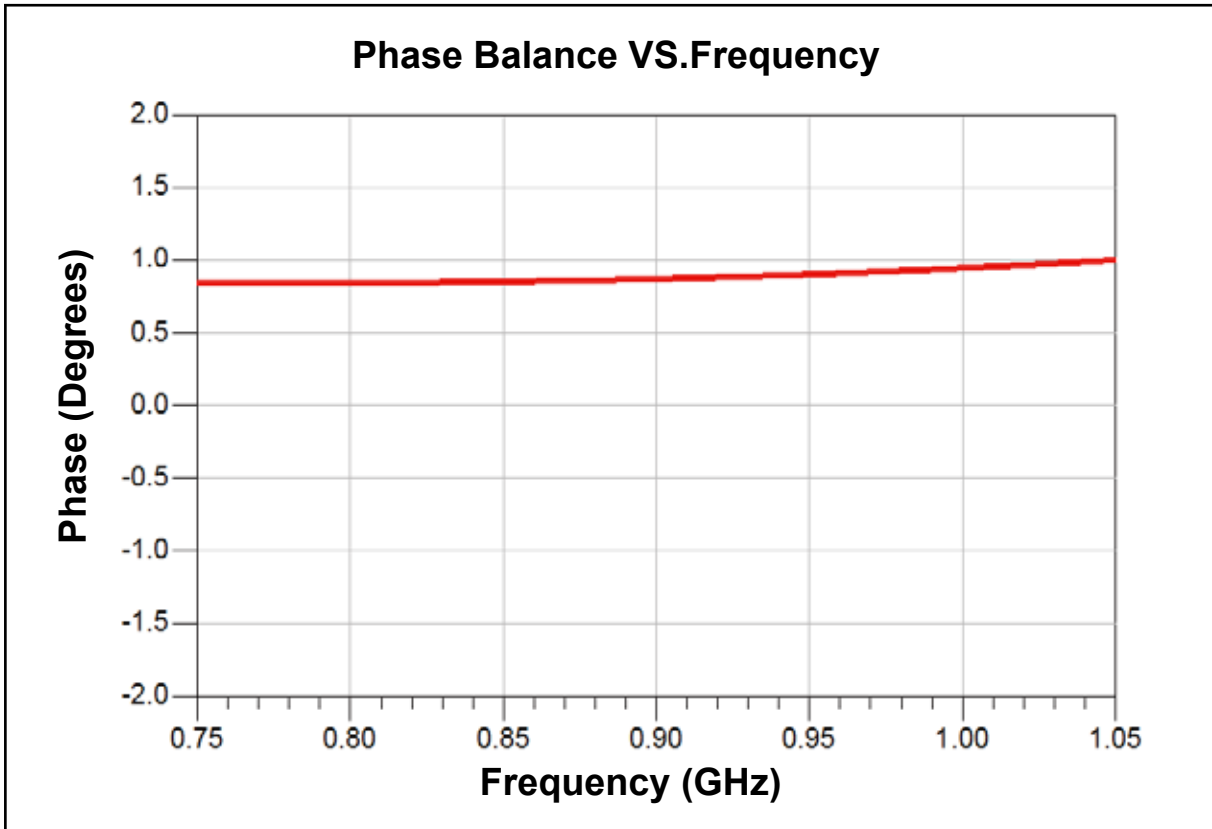

Yantel Corporation

Add : 3F, Building 3, Southern District 2 of Zhongguan Honghualing Industrial Park, Xili, Nanshan, Shenzhen, China

Tel : 86-755-8355-1886 Fax : 86-755-8355-2533

For detailed performance specs & shopping online see Yantel web site : www.yantel-corp.com

Data Sheet
PD0900U06-150
Power Divider/Combiner
4-Way 0° 50Ω 820-960 MHz

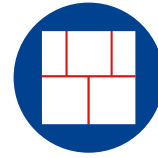

Yantel
Key Patents Lead Microwave Tech

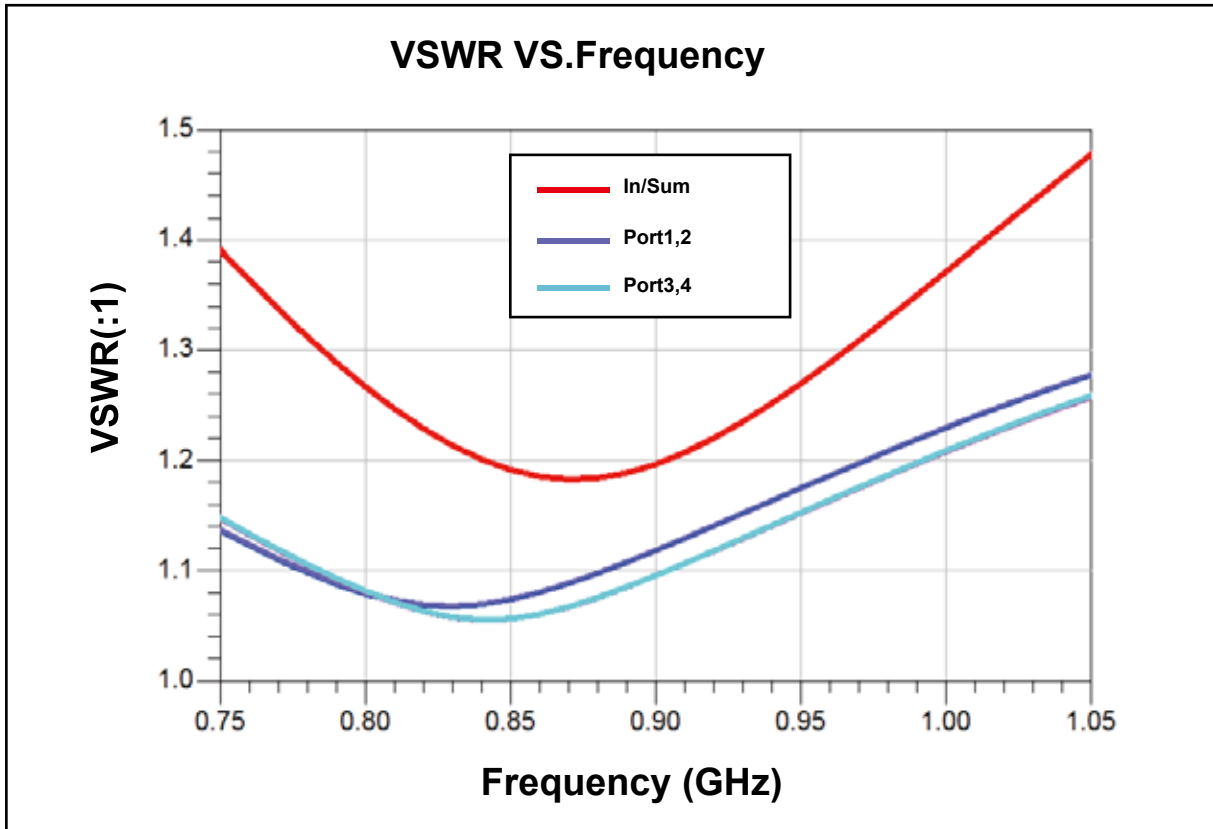

Yantel Corporation

Add : 3F, Building 3, Southern District 2 of Zhongguan Honghualing Industrial Park, Xili, Nanshan, Shenzhen, China

Tel : 86-755-8355-1886 Fax : 86-755-8355-2533

For detailed performance specs & shopping online see Yantel web site : www.yantel-corp.com

Data Sheet

PD0900U06-150

Power Divider/Combiner

4-Way 0° 50Ω 820-960 MHz



Outline Drawing

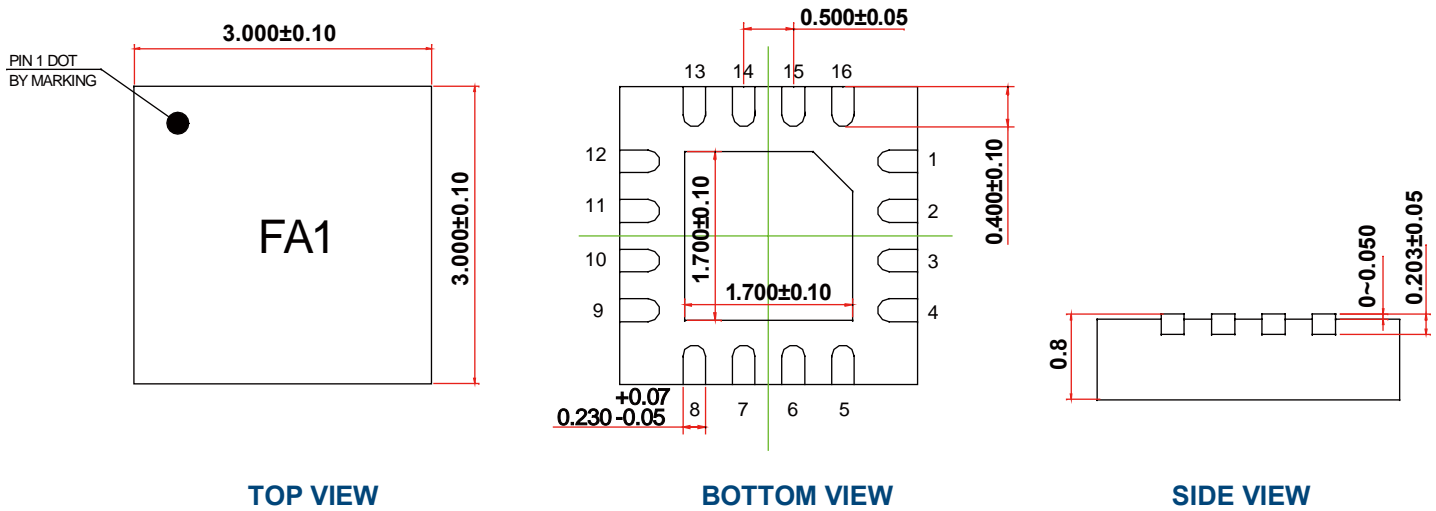

Land Pattern

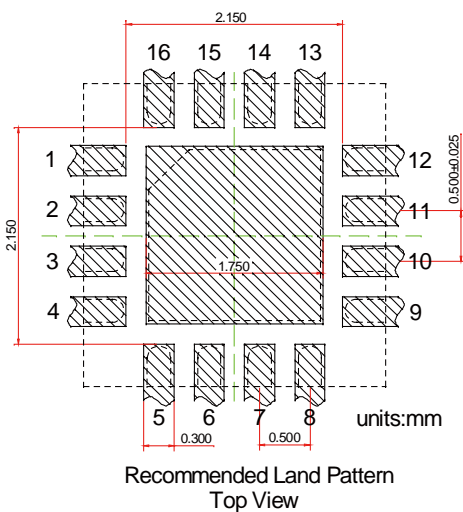

Pin Out

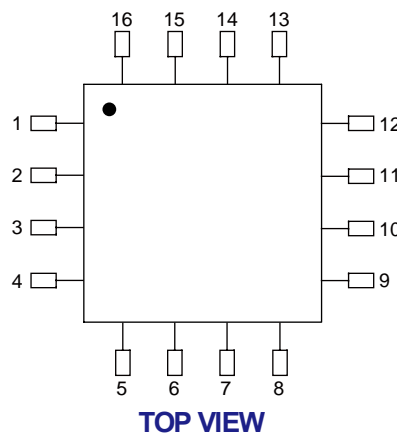

Pin #	Connection
1	GND
2	IN/SUM
3	NC
4	GND
5	GND
6	PORT 1
7	NC
8	PORT 2
9	NC
10	GND
11	GND
12	NC
13	PORT 3
14	NC
15	PORT 4
16	GND
Center Pad	GND

Notes: All dimensions show in millimeters

Yantel Corporation

Add : 3F, Building 3, Southern District 2 of Zhongguan Honghualing Industrial Park, Xili, Nanshan, Shenzhen, China

Tel : 86-755-8355-1886 Fax : 86-755-8355-2533

For detailed performance specs & shopping online see Yantel web site : www.yantel-corp.com