

TECHNICAL SPECIFICATION
MODEL NO. : PD104SL7

Customer's Confirmation

Customer _____

Date _____

By _____

PVI's Confirmation

Dep	FAE	Panel Design	Electronic Design	Mechanical Design	Product Verification	Prepared by
Sign	劉豐 2/20/06	秦金碧 2/17/06	施建嘉 2/16/06 金聖坤 2/16/06	申峰 2/16/06	張其 2/16/06	楊東 2/16/06

TECHNICAL SPECIFICATION**CONTENTS**

<i>NO.</i>	<i>ITEM</i>	<i>PAGE</i>
-	Cover	1
-	Contents	2
1	Application	3
2	Features	3
3	Mechanical Specifications	3
4	Mechanical Drawing of TFT-LCD module	4
5	Input Terminals	5
6	Absolute Maximum Ratings	7
7	Electrical Characteristics	7
8	Power On Sequence	13
9	Optical Characteristics	14
10	Handling Cautions	17
11	Reliability Test	18
12	Block Diagram	19
13	Packing	20
-	Revision History	21

1.Application

This data sheet applies to a color TFT LCD module, PD104SL7.

PD104SL7 module applies to notebook PC, sub-note-book PC and other OA product, which require high quality flat panel display. **This module is not designed for aerospace, avionics, medical, F/A, transportation, car or any other products, which require extreme level of reliability.**

Prime View assume no responsibility for any damage resulting from the use of the device which dose not comply with the instructions and the precautions in these specification sheet.

2. Features

- . Amorphous silicon TFT LCD panel with back-light unit
- . Pixel in stripe configuration
- . Slim and compact, designed for O/A application
- . Display Colors : 262,144 colors
- . Optimum Viewing Direction : 6 o'clock
- . 3.3V LVDS interface standard: THC63LVDF64A as receiver
- . +3.3V DC supply voltage for TFT LCD panel driving
- . Backlight driving DC/AC inverter not included in this module
- .Long Life Lamp

3.Mechanical Specifications

Parameter	Specifications	Unit
Screen Size	26.4(diagonal)	cm
	10.4 (diagonal)	inch
Display Format	800 X(R, G, B) X600	dot
Display Colors	262,144	
Active Area	211.2(H) X158.4 (V)	mm
Pixel Pitch	0.264 (H) X0.264 (V)	mm
Pixel Configuration	Stripe	
Outline Dimension	238.6 (w) X171.0(H) X6.0(typ.) (D)	mm
Weight	310(typ.),320(max.)	g
Back-light	Single CCFL, side-light type	
Surface treatment	Anti-glare	
Display mode	Normally white	

5. Input Terminals

5-1) TFT-LCD Panel Driving

Connector type: Molex 53779-1470

Pin No.	Symbol	Function	Remark
1	VDD	Power supply : +3.3V	
2	VDD	Power supply : +3.3V	
3	GND		
4	GND		
5	IN0-	Pixel data Transmission pair 0 (negative -)	
6	IN0+	Pixel data Transmission pair 0 (positive +)	
7	IN1-	Pixel data Transmission pair 1 (negative -)	
8	IN1+	Pixel data Transmission pair 1 (positive +)	
9	IN2-	Pixel data Transmission pair 2 (negative -)	
10	IN2+	Pixel data Transmission pair 2 (positive +)	
11	CLK-	Sampling Clock (negative -)	
12	CLK+	Sampling Clock (positive +)	
13	GND		
14	GND		

Recommended Transmitter (THC63LVDM63A Thine) to PD104SL7 interface Assignment:

Input terminal of THC63LVDM63A		Graphic controller output signal		Output signal symbol	To PD104SL7 interface terminal(Symbol)
Symbol	No.	Symbol	Function		
TIN0	44	R0	Red pixel data (LSB)	Tout0- Tout0+	No.5 : IN0- No.6 : IN0+
TIN1	45	R1	Red pixel data		
TIN2	47	R2	Red pixel data		
TIN3	48	R3	Red pixel data		
TIN4	1	R4	Red pixel data		
TIN5	3	R5	Red pixel data(MSB)	Tout1- Tout1+	No.7 : IN1- No.8 : IN1+
TIN6	4	G0	Green pixel data (LSB)		
TIN7	6	G1	Green pixel data		
TIN8	7	G2	Green pixel data		
TIN9	9	G3	Green pixel data		
TIN10	10	G4	Green pixel data	Tout2- Tout2+	No.9 : IN2- No.10 : IN2+
TIN11	12	G5	Green pixel data(MSB)		
TIN12	13	B0	Blue pixel data(LSB)		
TIN13	15	B1	Blue pixel data		
TIN14	16	B2	Blue pixel data		
TIN15	18	B3	Blue pixel data	TCLK out- TCLK out+	No.11 : CLK IN- No.12 : CLK IN+
TIN16	19	B4	Blue pixel data		
TIN17	20	B5	Blue pixel data(MSB)		
TIN18	22	NC	No connection		
TIN19	23	NC	No connection		
TIN20	25	ENAB	Compound Synchronization signal		
CLK in	26	NCLK	Data sampling clock		

Data stream of IN0-/+, IN1-/+ and IN2-/+ for PD104SL7



LVDS Interface Block Diagram

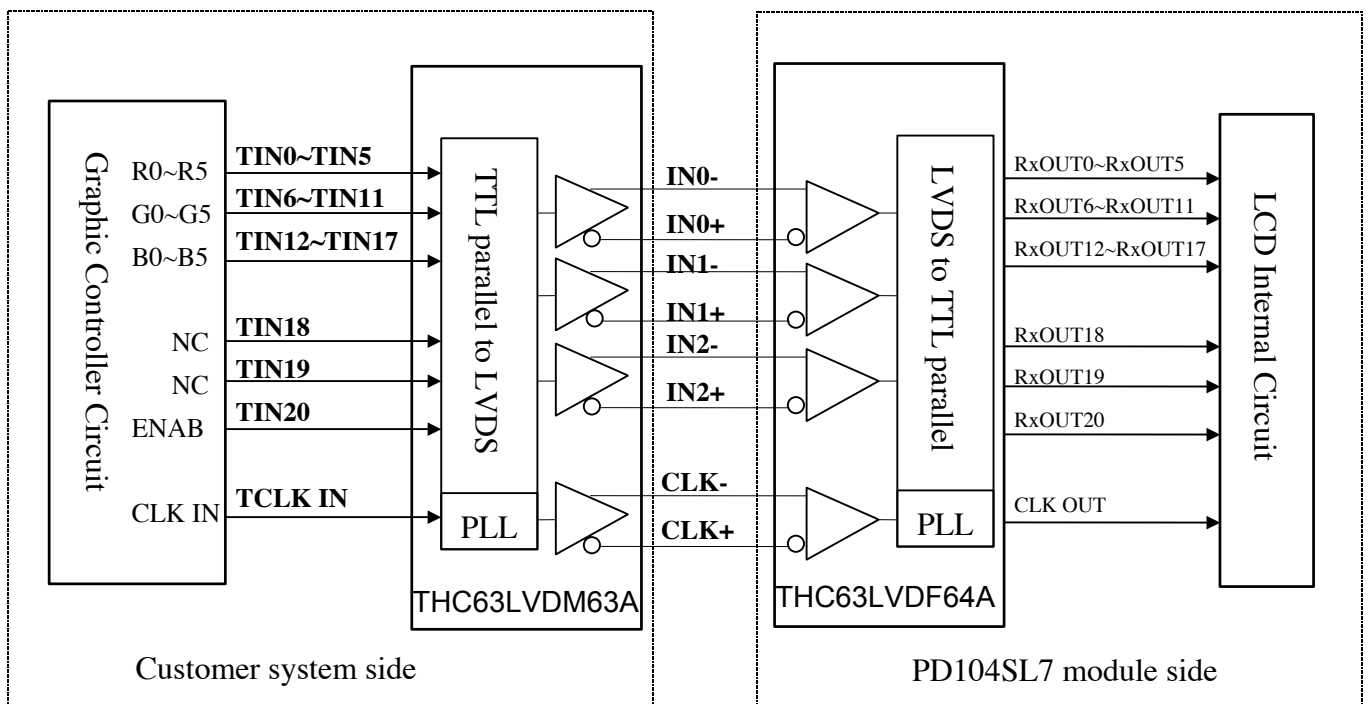

5-2) Backlight driving

Connector type : "BHSR-02VS-1" of Japan Solderless Terminal MFG Co. LTD

PIN NO.	Symbol	Description	Remark
1	VL1	Input Voltage(High)	
2	VL2	Input Voltage(Low)	

6. Absolute Maximum Ratings:

GND=0V, Ta=25°C

Parameters	Symbol	MIN.	MAX.	Unit	Remark
Supply Voltage	VDD	-0.3	+4.0	V	
Input Signals Voltage	V _{IN}	-0.3	VDD+0.3	V	Note 6-1
Backlight Driving Voltage	V _L	-	2000	V	
Backlight Driving Frequency	F _L	0	100	KHz	

Note 6-1: LVDS signal

7. Electrical Characteristics

7-1) Recommended Operating Conditions:

GND = 0V , Ta = 25°C

Item	Symbol	Min.	Typ.	Max.	Unit	Remark
Supply Voltage	VDD	3.0	3.3	3.6	V	
Current Dissipation	I _{DD}	-	350	450	mA	Note 7-1
LVDS Differential input high threshold	V _{TH}	-	-	100	mV	Note 7-2
LVDS Differential input low threshold	V _{TL}	-100	-	-		
Lamp Current	I _{FL}	3.0	5.0	7.0	mA	5mA : 230 cd/m2 Note 7-3 Note 7-6
Lamp Voltage	V _L	477	530	583	Vrms	I _{FL} =5mA Note 7-3
Starting Voltage (25°C) (Reference Value)	V _s	-	-	1110	Vrms	Note 7-4
Starting Voltage (0°C) (Reference Value)	V _s	-	-	1450	Vrms	
Lamp Driving Frequency	F _L	45	60	80	KHz	
Total power consumption (at I _{FL} =5mA)		--	3.6	-	W	Note 7-5

Note 7-1 : To test the current dissipation of VDD, using the “color bars” testing pattern shown as below

1	2	3	4	5	6	7	8
---	---	---	---	---	---	---	---

1. White
2. Yellow
3. Cyan
4. Green
5. Magenta
6. Red
7. Blue
8. Black

Idd current dissipation testing pattern

Note 7-2 :Please refers to THC63LVDF64A specification by Thine Corporation. This LCD module conforms to LVDS standard.

Note 7-3 : The back-light driving waveform should be as closed to sine-wave as possible.

In order to satisfy the quality of B/L , no matter use what kind of inverter , the output lamp current must between Min. and Max. to avoid the abnormal display image caused by B/L.

Note 7-4 : The "Max of starting voltage" means the minimum voltage of inverter to turn on the CCFL. and it should be applied to the lamp for more than 1 second to start up. Otherwise the lamp may not be turned on.

Note 7-5 : Not including the efficiency of backlight DC/AC inverter

Note 7-6 : Lamp current is measured with current meter for high frequency as shown below

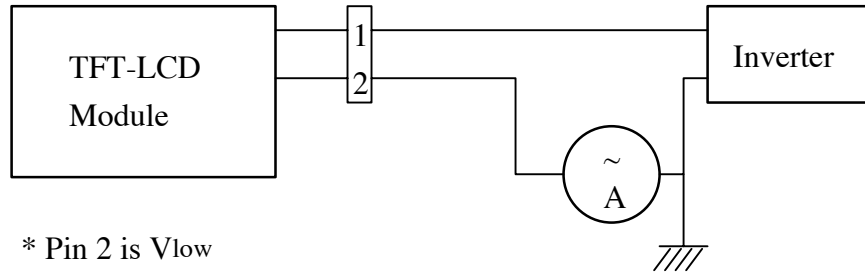

* Pin 2 is Vlow
 ** Current meter :
 Yokogawa 2016-01

Lamp current dissipation testing configuration

7-2) Input / Output signal timing chart

(A) Vertical Timing

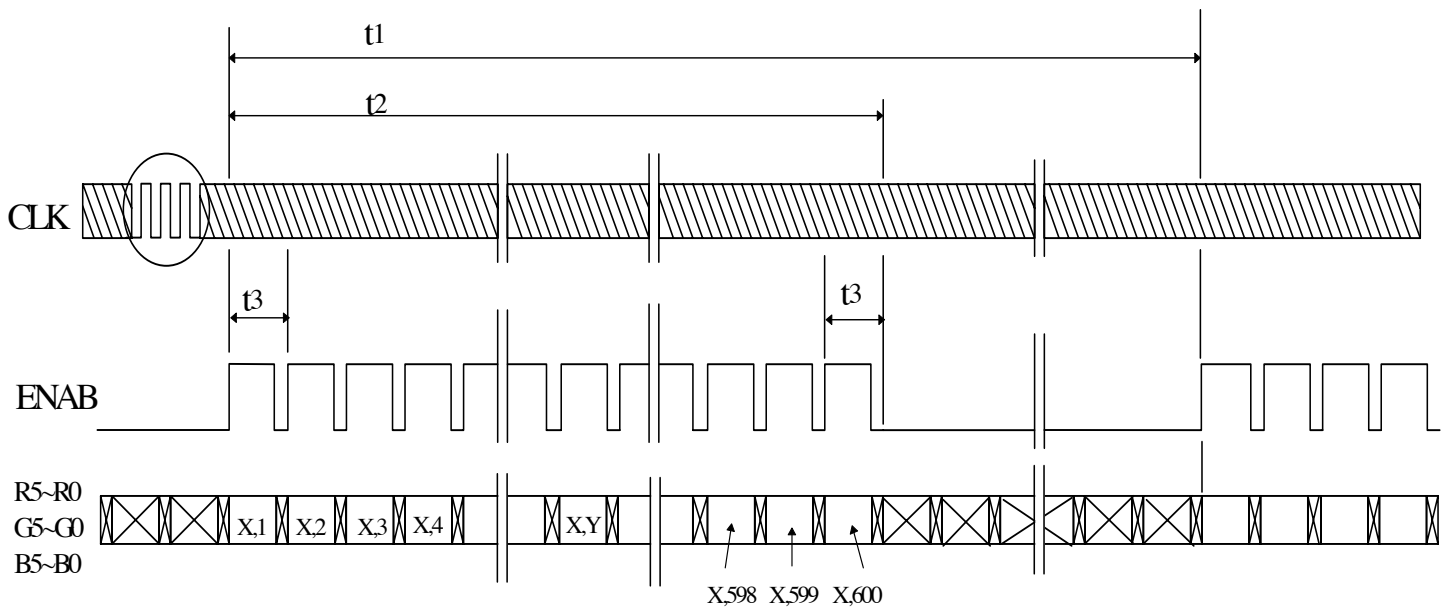

(B) Horizontal Timing

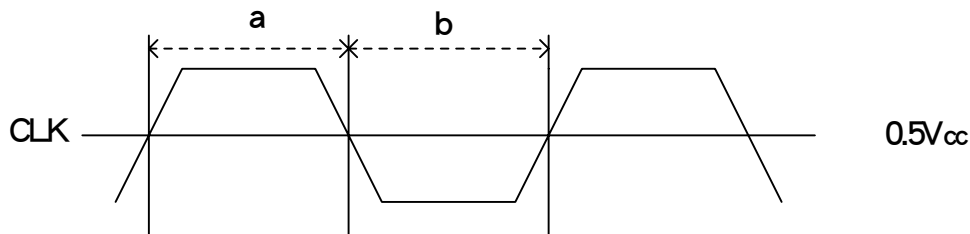
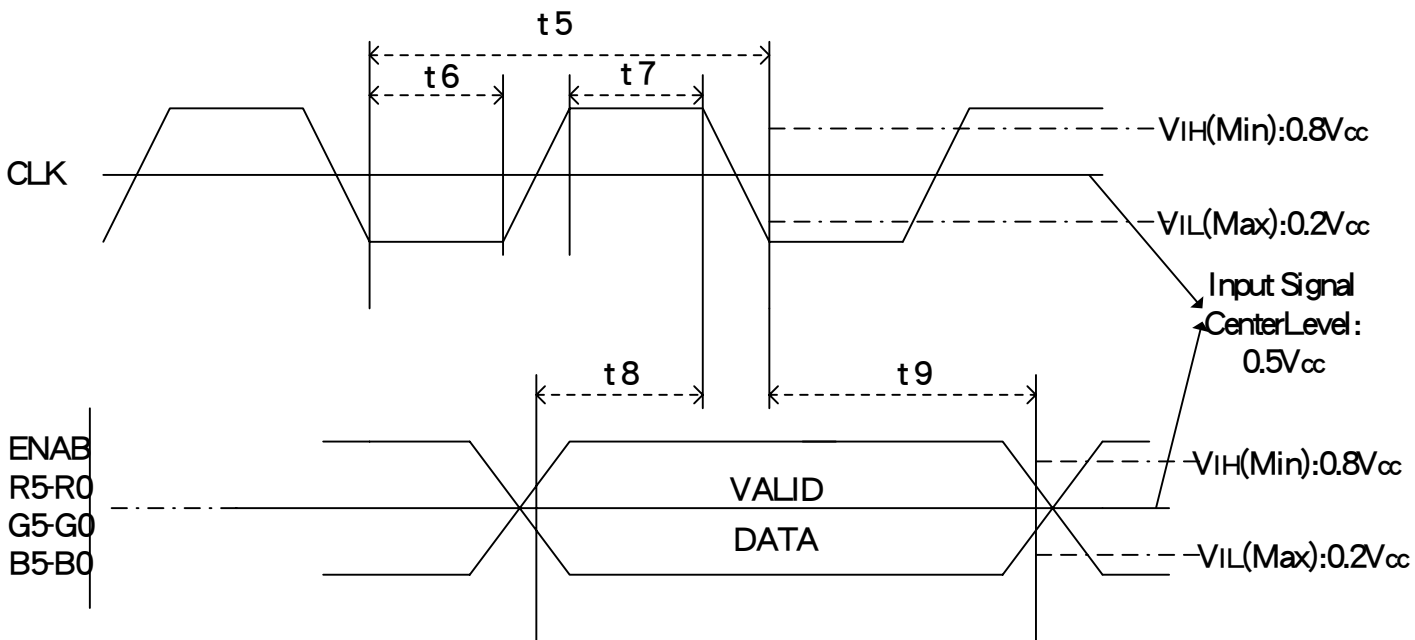
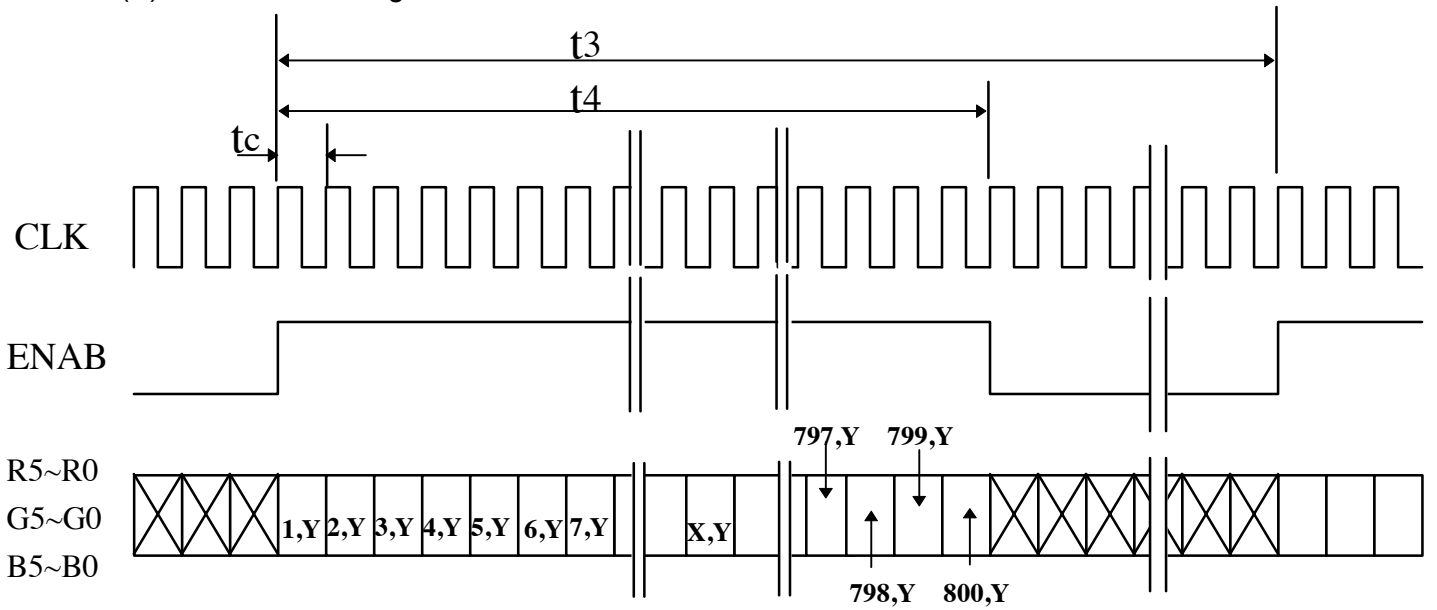

Duty (a , b) : $50 \pm 10\%$

C) Timing Specifications

Item	Symbol	Min.	Typ.	Max.	Unit	Remark
Frame Cycling	t1	604 X t3	628X t3	800 X t3	-	
		-	16.58	-	ms	
Vertical Display Period	t2	600 X t3	600 X t3	600 X t3	-	
Horizontal Scanning Time	t3	920 X t5	1056 X t5	1064 X t5	-	
		-	26.4	-	μ s	
Horizontal Display Period	t4	-	800 X t5	-	-	
Clock Cycle	t5		25.0	-	ns	
Clock High Level Time	t6	9.0	-	-	ns	
Clock Low Level Time	t7	9.0	-	-	ns	
Hold time	t8	4.0	-	-	ns	
Set-up time	t9	5.0	-	-	ns	

7-3) Display Color and Gray Scale Reference

Color		Input Color Data																	
		Red						Green						Blue					
		R5	R4	R3	R2	R1	R0	G5	G4	G3	G2	G1	G0	B5	B4	B3	B2	B1	B0
Basic Colors	Black	0	0	0	0	0	0	0	0	0	0	0	0	0	0	0	0	0	0
	Red (63)	1	1	1	1	1	1	0	0	0	0	0	0	0	0	0	0	0	0
	Green (63)	0	0	0	0	0	0	1	1	1	1	1	1	0	0	0	0	0	0
	Blue (63)	0	0	0	0	0	0	0	0	0	0	0	0	1	1	1	1	1	1
	Cyan	0	0	0	0	0	0	1	1	1	1	1	1	1	1	1	1	1	1
	Magenta	1	1	1	1	1	1	0	0	0	0	0	0	1	1	1	1	1	1
	Yellow	1	1	1	1	1	1	1	1	1	1	1	1	0	0	0	0	0	0
	White	1	1	1	1	1	1	1	1	1	1	1	1	1	1	1	1	1	1
Red	Red (00)	0	0	0	0	0	0	0	0	0	0	0	0	0	0	0	0	0	0
	Red (01)	0	0	0	0	0	1	0	0	0	0	0	0	0	0	0	0	0	0
	Red (02)	0	0	0	0	1	0	0	0	0	0	0	0	0	0	0	0	0	0
	Darker																		
	↓	↓	↓	↓	↓	↓	↓	↓	↓	↓	↓	↓	↓	↓	↓	↓	↓	↓	↓
	Brighter																		
	Red (61)	1	1	1	1	0	1	0	0	0	0	0	0	0	0	0	0	0	0
	Red (62)	1	1	1	1	1	0	0	0	0	0	0	0	0	0	0	0	0	0
Red (63)	1	1	1	1	1	1	0	0	0	0	0	0	0	0	0	0	0	0	
Green	Green (00)	0	0	0	0	0	0	0	0	0	0	0	0	0	0	0	0	0	0
	Green (01)	0	0	0	0	0	0	0	0	0	0	0	1	0	0	0	0	0	0
	Green (02)	0	0	0	0	0	0	0	0	0	0	1	0	0	0	0	0	0	0
	Darker																		
	↓	↓	↓	↓	↓	↓	↓	↓	↓	↓	↓	↓	↓	↓	↓	↓	↓	↓	↓
	Brighter																		
	Green (61)	0	0	0	0	0	0	1	1	1	1	0	1	0	0	0	0	0	0
	Green (62)	0	0	0	0	0	0	1	1	1	1	1	0	0	0	0	0	0	0
Green (63)	0	0	0	0	0	0	1	1	1	1	1	1	0	0	0	0	0	0	
Blue	Blue (00)	0	0	0	0	0	0	0	0	0	0	0	0	0	0	0	0	0	0
	Blue (01)	0	0	0	0	0	0	0	0	0	0	0	0	0	0	0	0	0	1
	Blue (02)	0	0	0	0	0	0	0	0	0	0	0	0	0	0	0	0	1	0
	Darker																		
	↓	↓	↓	↓	↓	↓	↓	↓	↓	↓	↓	↓	↓	↓	↓	↓	↓	↓	↓
	Brighter																		
	Blue (61)	0	0	0	0	0	0	0	0	0	0	0	0	1	1	1	1	0	1
	Blue (62)	0	0	0	0	0	0	0	0	0	0	0	0	1	1	1	1	1	0
Blue (63)	0	0	0	0	0	0	0	0	0	0	0	0	1	1	1	1	1	1	

7-4) Pixel Arrangement

The LCD module pixel arrangement is the stripe.

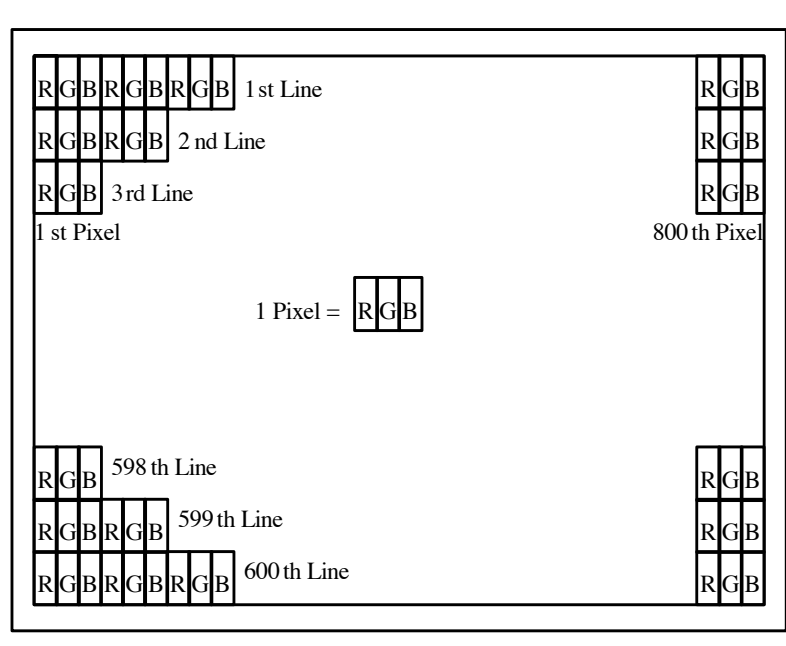

8 .Power On Sequence

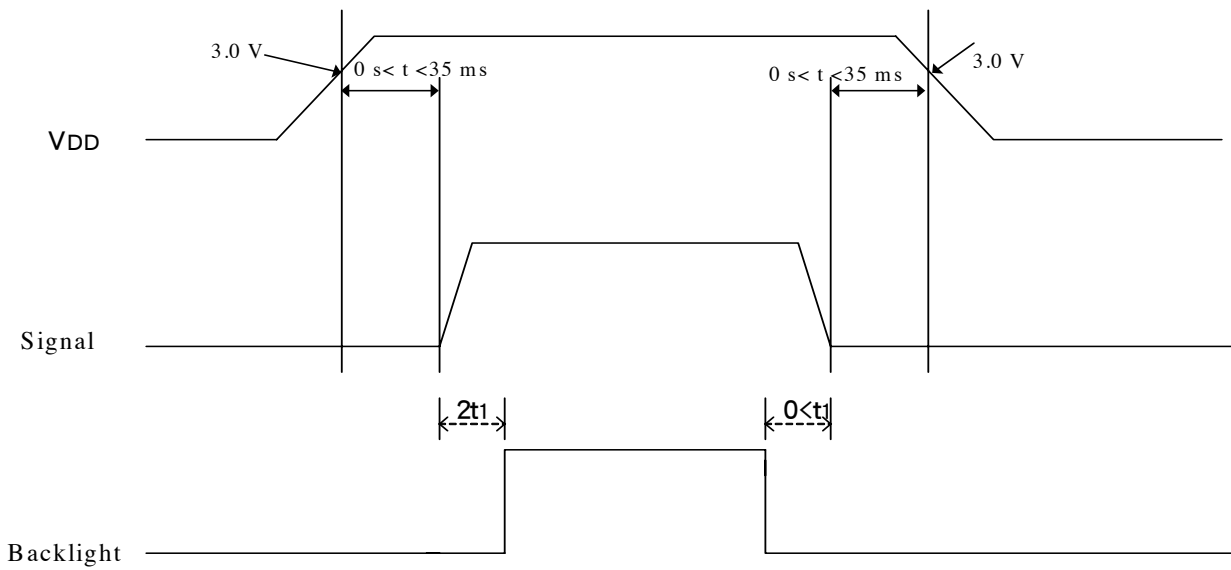

1. The supply voltage for input signals should be same as V_{DD} .
2. When the power is off , please keep whole signals (ENAB,CLK, Data) low level or high impedance

9. Optical Characteristics

9-1) Specification:

Ta = 25°C

Parameter		Symbol	Condition	MIN.	TYP.	MAX.	Unit	Remarks
Viewing Angle	Horizontal	θ	CR \geq 10	40	45	-	deg	
	Vertical	θ (to 12 o'clock)		10	15	-	deg	Note 9-1
		θ (to 6 o'clock)		35	40	-	deg	
Contrast Ratio		CR	Optimum direction	200	400	-	-	Note 9-2
Response time	Rise	Tr	$\theta = 0^\circ$	-	15	50	ms	Note 9-4
	Fall	Tf	$\phi = 0^\circ$	-	25	50	ms	
Luminance		L	$\theta = 0^\circ / \phi = 0^\circ$	200	230	-	cd/m ²	I _{FL} =5mA, Note 9-3
Luminance Uniformity		U		70	80	-	%	Note 9-5
White Chromaticity		x		0.29	0.32	0.35	-	
		y		0.32	0.35	0.38	-	
Lamp Life Time				20000	-	-	hr	I _{FL} =5mA
Cross Talk Ratio		CTK		-	-	3.5	%	Note 9-6

All the optical measurement shall be executed 30 minutes after backlight being turn-on. The optical characteristics shall be measured in dark room (ambient illumination on panel surface less than 1 Lux). The measuring configuration shows as following figure.

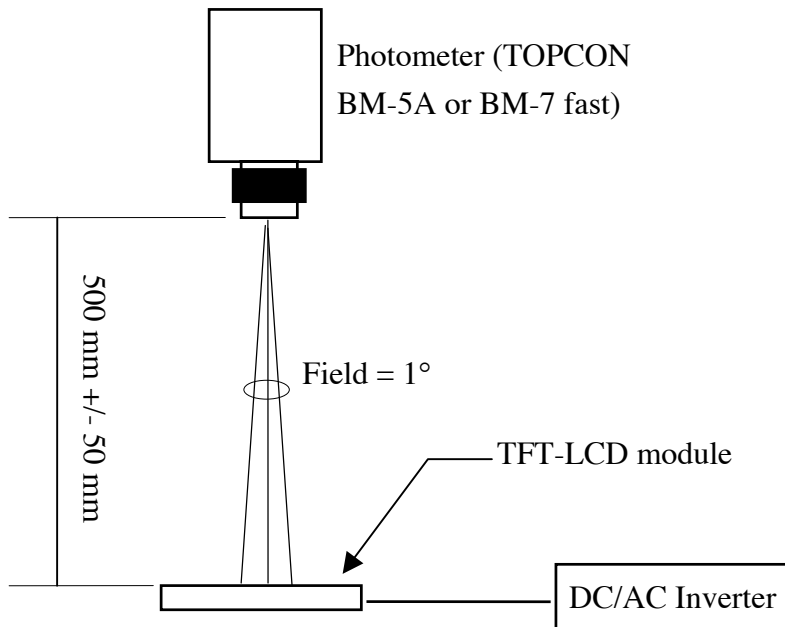

Optical characteristics measuring configuration

Note 9-1 : The definitions of viewing angles are as follows.

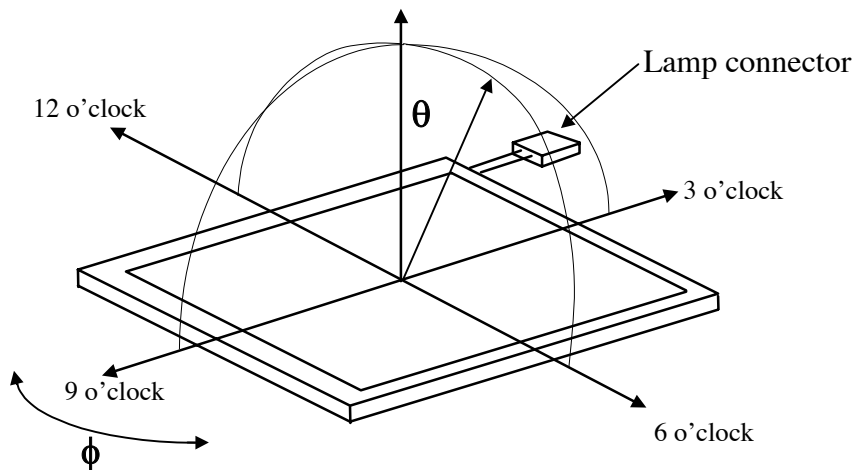

Note 9-2 : The definition of contrast ratio $CR = \frac{\text{Luminance at gray level 63}}{\text{Luminance at gray level 0}}$

Note 9-3 : The typical luminance value is measured at lamp current 5.0 mA. The max luminance value is measured at lamp current 7.0 mA.

Note 9-4: Definition of Response Time T_r and T_f :

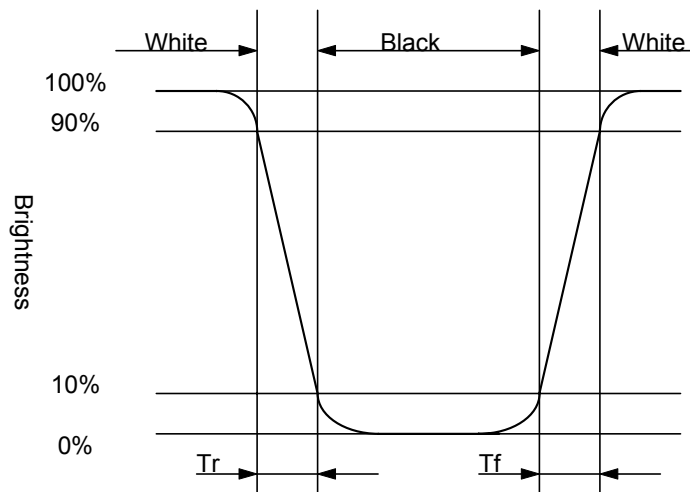

Note 9-5: The uniformity of LCD is defined as

$$U = \frac{\text{The Minimum Brightness of the 9 testing Points}}{\text{The Maximum Brightness of the 9 testing Points}}$$

Luminance meter : BM-5A or BM-7 fast(TOPCON)

Measurement distance : 500 mm +/- 50 mm

Ambient illumination : < 1 Lux

Measuring direction : Perpendicular to the surface of module

The test pattern is white (Gray Level 63).

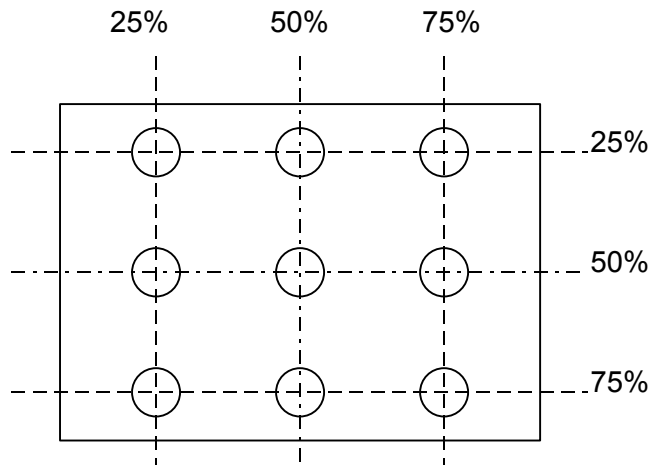

Note 9-6: Cross Talk (CTK) = $\frac{|YA-YB|}{YA} \times 100\%$

YA: Brightness of Pattern A

YB: Brightness of Pattern B

Luminance meter : BM 5A (TOPCON)

Measurement distance : 500 mm +/- 50 mm

Ambient illumination : < 1 Lux

Measuring direction : Perpendicular to the surface of module

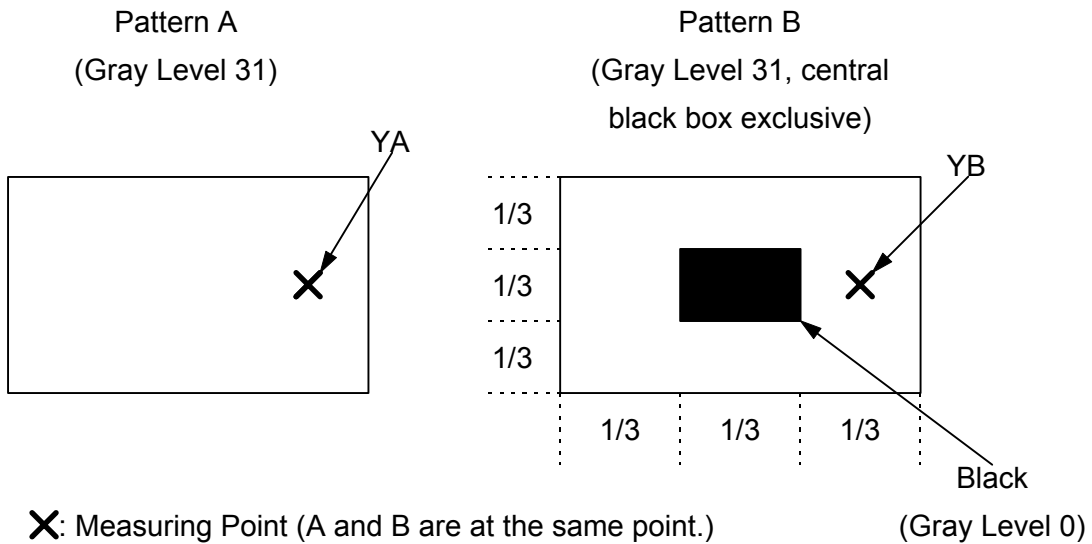

10. Handling Cautions

10-1) Mounting of module

- a) Please power off the module when you connect the input/output connector.
- b) Please connect the ground pattern of the inverter circuit surely. If the connection is not perfect, some following problems may happen possibly.
 1. The noise from the backlight unit will increase.
 2. The output from inverter circuit will be unstable.
 3. In some cases a part of module will heat.
- c) Polarizer which is made of soft material and susceptible to flaw must be handled carefully.
- d) Protective film (Laminator) is applied on surface to protect it against scratches and dirt. It is recommended to peel off the laminator before use and taking care of static electricity.

10-2) Precautions in mounting

- a) When metal part of the TFT-LCD module (shielding lid and rear case) is soiled, wipe it with soft dry cloth.
- b) Wipe off water drops or finger grease immediately. Long contact with water may cause discoloration or spots.
- c) TFT-LCD module uses glass which breaks or cracks easily if dropped or bumped on hard surface. Please handle with care.
- d) Since CMOS LSI is used in the module. So take care of static electricity and earth yourself when handling.

10-3) Adjusting module

- a) Adjusting volumes on the rear face of the module have been set optimally before shipment.
- b) Therefore, do not change any adjusted values. If adjusted values are changed, the specifications described may not be satisfied.

10-4) Others

- a) Do not expose the module to direct sunlight or intensive ultraviolet rays for many hours.
- b) Store the module at a room temperature place.
- c) The voltage of beginning electric discharge may over the normal voltage because of leakage current from approach conductor by to draw lump read lead line around.
- d) If LCD panel breaks, it is possibly that the liquid crystal escapes from the panel. Avoid putting it into eyes or mouth. When liquid crystal sticks on hands, clothes or feet. Wash it out immediately with soap.
- e) Observe all other precautionary requirements in handling general electronic components.
- f) Please adjust the voltage of common electrode as material of attachment by 1 module.

11. Reliability Test

No	Test Item	Test Condition	Remark
1	High Temperature Storage Test	Ta = +70°C, 240 hrs	
2	Low Temperature Storage Test	Ta = -20°C, 240 hrs	
3	High Temperature Operation Test	Ta = +60°C, 240 hrs	
4	Low Temperature Operation Test	Ta = 0°C, 240 hrs	
5	High Temperature & High Humidity Operation Test	Ta = +60°C, 80%RH, 240 hrs (No Condensation)	
6	Thermal Cycling Test (non-operating)	0°C ← → +60°C, 100 Cycles 1Hr 1Hr	
7	Vibration Test (non-operating)	Frequency : 10 ~ 57 Hz, Amplitude : 0.15 mm 58~500Hz, 1G Sweep time: 11 min Test Period: 3 hrs (1 hr for each direction of X, Y, Z)	
8	Shock Test (non-operating)	80G, 6ms, X,Y, Z 1 times for each direction	
9	Electron Static Discharge	C=150pF,R=330Ω Contact=±8KV Air=±15KV 10 times/terminal	

Ta: ambient temperature

Note: The protective film must be removed before temperature test

[Criteria]

1. Main LCD should normally work under the normally condition no defect of function, screen quality and appearance (including : mura ,line defect ,no image)
2. After the temperature and humidity test, the luminance and CR (Contrast ratio) ,should not be lower than minimum of specification.
3. After the vibration and shock test , can't be found chip broken.

12. Block Diagram

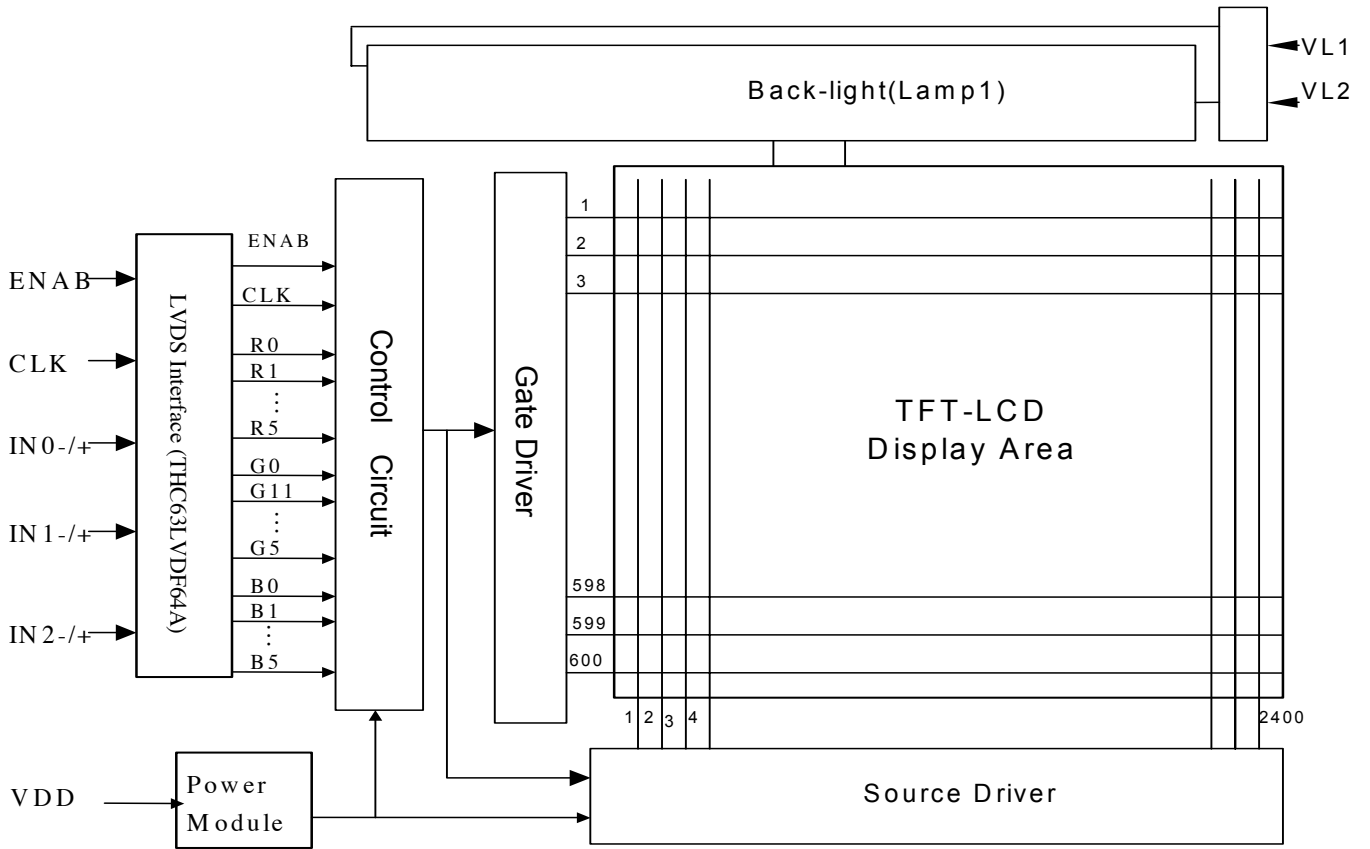

13.Packing

ZONE	REV.	DOCUMENT NO.	DESCRIPTION	DATE	REV.BY
<p>NOTE:</p> <p>1.Q'TY: 10 pcs modoule/carton. 2.Dimension: 530*295*230mm 3.Weight: 5.4 Kg</p>					
4		50-0100111	CARTON	1	
3		50-0500061	防静电气泡袋 Pink	10 防静电	
2		PD104SL7	10.4"SVGA module	10	
1		50-0301281	10.4"SVGA 防静电隔板(10u)	1 上盖+底座	
ITEM	PART NO.	DESCRIPTION		QTY	REMARK
MTL.SPEC.		UNSPECIFIED TOL'S		REMARK	
		ANGLE			
		ROUGHNESS			
APPROVE	Frank	'05.12.06	SCALE	UNIT	SHEET 1 OF 1
CHECK	Frank	'05.12.06			
DRAWN	Patrick	'05.12.06	MTL.NO.		DWG FILE:
				REV. 02	A4 SIZE

元太科技工業股份有限公司
 Prime View International Co., Ltd.

PD104SL7 MODULE PACKING

Revision History

Rev.	Issued Date	Revised Content
0.1	Oct.19,2005	-
1.0	Dec.6.2005	New
1.1	Feb.14,2006	Modify Page14: 9. Optical Characteristics 9-1) Specification→Life time from 15000(hr) change to 20000(hr)(Min)