



	PD2401	Units
AC Operating Voltage	120	$V_{RMS}$
Load Current	1	A
On-State Voltage Drop	1.2	$V_{RMS}$ ( $A_T I_L = 1A$ )

### Features

- Load Current up to 1A
- Blocking Voltage to 600V
- 5mA Sensitivity
- Zero-Crossing Detection
- DC Control, AC Output
- Optically Isolated
- TTL and CMOS Compatible
- Low EMI and RFI Generation
- High Noise Immunity
- VDE compatible
- Machine Insertable, Wave Solderable

### Applications

- Programmable Control
- Process Control
- Power Control Panels
- Remote Switching
- Gas Pump Electronics
- Contractors
- Large Relays
- Solenoids
- Motors
- Heaters

### Description

The PD2401 is an AC Solid State Switch using optical coupling with dual power SCR outputs to produce an alternative to optocoupler and Triac circuits. The PD2401 switches are robust enough to provide a blocking voltage of up to 500V and max surge current rating of 20A. In addition, tightly controlled zero cross circuitry ensures switching of AC loads without the generation of transients. The input and output circuits are optically coupled to provide 3750V of isolation and noise immunity between control and load circuits. As a result the PD2401 is well suited for industrial environments where electromagnetic interference would disrupt the operation of electromechanical relays.

### Approvals

- UL recognized file #: E69938
- CSA certified file #: LR 43639-8

### Ordering Information

Part #	Description
PD2401	16 Pin DIP (25/Tube)

### Pin Configuration

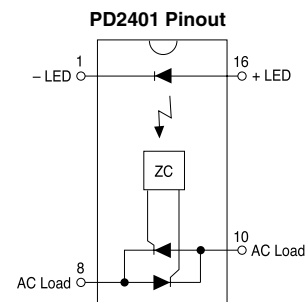

**Absolute Maximum Ratings (@ 25° C)**

Parameter	Min	Typ	Max	Units
Input Power Dissipation	-	-	150 <sup>1</sup>	mW
Input Control Current	-	-	50	mA
Peak (10ms)	-	-	1	A
Reverse Input Voltage	-	-	5	V
Total Package Dissipation PD	-	-	1600 <sup>2</sup>	mW
Isolation Voltage Input to Output	3750	-	-	V <sub>RMS</sub>
Operational Temperature	-40	-	+85	°C
Storage Temperature	-40	-	+125	°C
Soldering Temperature				
DIP Package	-	-	+260	°C
Surface Mount Package (10 Seconds Max.)	-	-	+220	°C

<sup>1</sup> Derate Linearly 1.33 mW/°C

<sup>2</sup> Derate Linearly 16.6 mW/°C

*Absolute Maximum Ratings are stress ratings. Stresses in excess of these ratings can cause permanent damage to the device. Functional operation of the device at these or any other conditions beyond those indicated in the operational sections of this data sheet is not implied. Exposure of the device to the absolute maximum ratings for an extended period may degrade the device and effect its reliability.*

**Electrical Characteristics**

Parameters	Conditions	Symbol	Min	Typ	Max	Units
<b>Output Characteristics @ 25°C</b>						
Peak Blocking Voltage	-	V <sub>DRM</sub>	-	-	500	V
Load Current (Continuous)	V <sub>L</sub> =120-240VAC	I <sub>L</sub>	0.005	-	1	A
Off State Leakage Current	V <sub>DRM</sub>	I <sub>LEAK</sub>	-	-	1	mA
On-State Voltage Drop	I <sub>L</sub> =1A		-	-	1.2	V <sub>RMS</sub>
Critical Rate of Rise	dv/dt		1000	1200	-	V/μS
Switching Speeds						
Turn-on	I <sub>F</sub> =5 mA	T <sub>ON</sub>	-	-	0.5	Cycles
Turn-off	I <sub>F</sub> =5 mA	T <sub>OFF</sub>	-	-	0.5	Cycles
Zero-Cross Turn-On Voltage	1st half cycle		-	2	5	V
	Sub. half cycle		-	-	1	V
Operating Frequency <sup>1</sup>	-		20	-	500	Hz
Load Power Factor for Guaranteed Turn-On <sup>2</sup>	-	PF	0.25	-	-	-
Capacitance Input to Output		-	-	-	-	pF
<b>Input Characteristics @ 25°C</b>						
Input Control Current						
For Normal Environment	-	I <sub>F</sub>	5	-	50	mA
For High Noise Environment	-	I <sub>F</sub>	10	-	100	mA
Input Voltage Drop	I <sub>F</sub> =5mA	V <sub>F</sub>	0.9	1.2	1.4	V
Input Drop-out Voltage	-		0.8	-	-	V
Reverse Input Current	V <sub>R</sub> =5V	I <sub>R</sub>	-	-	10	uA
<b>Common Characteristics @ 25°C</b>						
Input to Output Capacitance	-	C <sub>I/O</sub>	-	-	3	V <sub>RMS</sub>
Input to Output Isolation	-	V <sub>I/O</sub>	3750	-	-	V <sub>RMS</sub>

<sup>1</sup> Zero cross 1st 1/2 cycle @ <100Hz

<sup>2</sup> Snubber circuits may be required at low power factors.

PERFORMANCE DATA\*

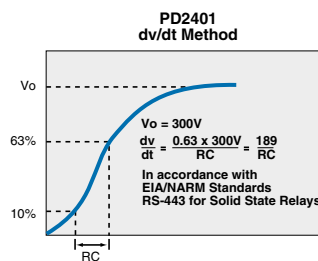
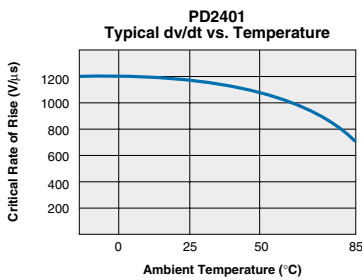
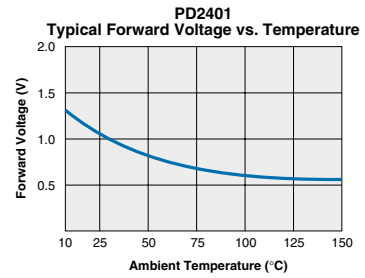
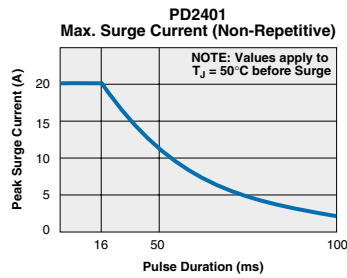
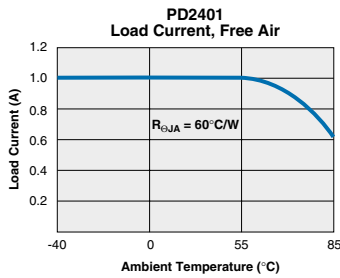

Mechanical Dimensions

16 Pin DIP

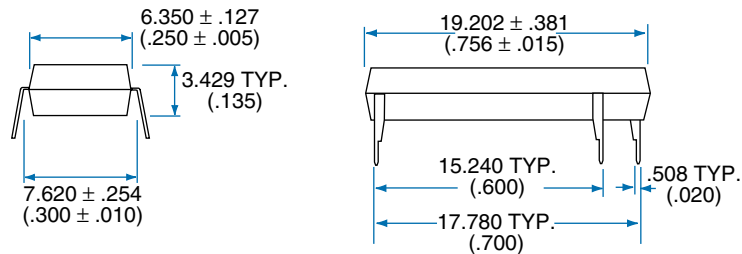

The Performance data shown in the graphs above is typical of device performance. For guaranteed parameters not indicated in the written specifications, please contact our application department.

**CLARE LOCATIONS**

Clare Headquarters  
78 Cherry Hill Drive  
Beverly, MA 01915  
Tel: 1-978-524-6700  
Fax: 1-978-524-4900  
Toll Free: 1-800-27-CLARE

Clare Micronix Division  
145 Columbia  
Aliso Viejo, CA 92656-1490  
Tel: 1-949-831-4622  
Fax: 1-949-831-4628

**SALES OFFICES**

**AMERICAS**

**Americas Headquarters**

Clare  
78 Cherry Hill Drive  
Beverly, MA 01915  
Tel: 1-978-524-6700  
Fax: 1-978-524-4900  
Toll Free: 1-800-27-CLARE

**Eastern Region**

Clare  
P.O. Box 856  
Mahwah, NJ 07430  
Tel: 1-201-236-0101  
Fax: 1-201-236-8685  
Toll Free: 1-800-27-CLARE

**Central Region**

Clare Canada Ltd.  
3425 Harvester Road, Suite 202  
Burlington, Ontario L7N 3N1  
Tel: 1-905-333-9066  
Fax: 1-905-333-1824

**Western Region**

Clare  
1852 West 11th Street, #348  
Tracy, CA 95376  
Tel: 1-209-832-4367  
Fax: 1-209-832-4732  
Toll Free: 1-800-27-CLARE

**Canada**

Clare Canada Ltd.  
3425 Harvester Road, Suite 202  
Burlington, Ontario L7N 3N1  
Tel: 1-905-333-9066  
Fax: 1-905-333-1824

**EUROPE**

**European Headquarters**

CP Clare nv  
Bampslaan 17  
B-3500 Hasselt (Belgium)  
Tel: 32-11-300868  
Fax: 32-11-300890

**France**

Clare France Sales  
Lead Rep  
99 route de Versailles  
91160 Champlan  
France  
Tel: 33 1 69 79 93 50  
Fax: 33 1 69 79 93 59

**Germany**

Clare Germany Sales  
ActiveComp Electronic GmbH  
Mitterstrasse 12  
85077 Manching  
Germany  
Tel: 49 8459 3214 10  
Fax: 49 8459 3214 29

**Italy**

C.L.A.R.E.s.a.s.  
Via C. Colombo 10/A  
I-20066 Melzo (Milano)  
Tel: 39-02-95737160  
Fax: 39-02-95738829

**Sweden**

Clare Sales  
Comptronic AB  
Box 167  
S-16329 Spånga  
Tel: 46-862-10370  
Fax: 46-862-10371

**United Kingdom**

Clare UK Sales  
Marco Polo House  
Cook Way  
Bindon Road  
Taunton  
UK-Somerset TA2 6BG  
Tel: 44-1-823 352541  
Fax: 44-1-823 352797

**ASIA/PACIFIC**

**Asian Headquarters**

Clare  
Room N1016, Chia-Hsin, Bldg II,  
10F, No. 96, Sec. 2  
Chung Shan North Road  
Taipei, Taiwan R.O.C.  
Tel: 886-2-2523-6368  
Fax: 886-2-2523-6369

<http://www.clare.com>

---

*Clare cannot assume responsibility for use of any circuitry other than circuitry entirely embodied in this Clare product. No circuit patent licenses nor indemnity are expressed or implied. Clare reserves the right to change the specification and circuitry, without notice at any time. The products described in this document are not intended for use in medical implantation or other direct life support applications where malfunction may result in direct physical harm, injury or death to a person.*

---