

Features

- Fast Switching Speed
- **Lead Free Finish/RoHS Compliant (Note 3)**
- **"Green" Molding Compound (No Br, Sb) (Note 4)**
- **Qualified to AEC-Q101 Standards for High Reliability**

Mechanical Data

- Case: Power DI™323
- Case Material: Molded Plastic, "Green" Molding Compound. UL Flammability Classification Rating 94V-0
- Moisture Sensitivity: Level 1 per J-STD-020C
- Leads: Matte Tin Finish annealed over Copper Leadframe. Solderable per MIL-STD-202, Method 208 (E3)
- Polarity: Cathode Band
- Marking: Date Code and Type Code, See Page 3
- Weight: 0.005 grams (approximate)



TOP VIEW

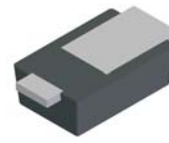

BOTTOM VIEW

Maximum Ratings @ T_A = 25°C unless otherwise specified

Characteristic	Symbol	Value	Unit
Non-Repetitive Peak Reverse Voltage	V _{RM}	100	V
Peak Repetitive Reverse Voltage Working Peak Reverse Voltage DC Blocking Voltage	V _{RRM} V _{RWM} V _R	80	V
RMS Reverse Voltage	V _{R(RMS)}	57	V
Forward Continuous Current	I _{FM}	250	mA
Repetitive Peak Forward Current	I _{FRM}	500	mA
Non-Repetitive Peak Forward Surge Current @ t = 1.0ms @ t = 1.0s	I _{FSM}	3.3 1.0	A
Thermal Resistance Junction to Ambient Air (Note 2)	R _{θJA}	260	°C/W
Operating and Storage Temperature Range	T _j , T _{STG}	-65 to +150	°C

Electrical Characteristics @ T_A = 25°C unless otherwise specified

Characteristic	Symbol	Min	Max	Unit	Test Condition
Reverse Breakdown Voltage (Note 1)	V _{BR(R)}	80	—	V	I _R = 1μA
Forward Voltage	V _F	—	0.715 0.72 0.855 0.90 1.0 1.25	V	I _F = 1.0mA I _F = 5.0mA I _F = 10mA I _F = 50mA I _F = 100mA I _F = 150mA
Leakage Current (Note 1)	I _R	—	25 30 100 30 50	nA nA μA μA	V _R = 20V V _R = 25V V _R = 80V V _R = 25V, T _j = 150°C V _R = 75V, T _j = 150°C
Total Capacitance	C _T	—	1.5 1.2	pF	V _R = 0, f = 1.0MHz V _R = 0.5V, f = 1MHz
Reverse Recovery Time	t _{rr}	—	4.0	ns	I _F = I _R = 10mA, I _{rr} = 0.1 x I _R , R _L = 100Ω

- Notes:
1. Short duration test pulse used to minimize self-heating.
 2. Part mounted on FR-4 PC board with recommended pad layout, which can be found on our website at <http://www.diodes.com/datasheets/ap02001.pdf>.
 3. RoHS revision 13.2.2003. Glass and High Temperature Solder Exemptions Applied, see *EU Directive Annex Notes 5 and 7*.
 4. Diodes Inc.'s "Green" policy can be found on our website at http://www.diodes.com/products/lead_free/index.php.

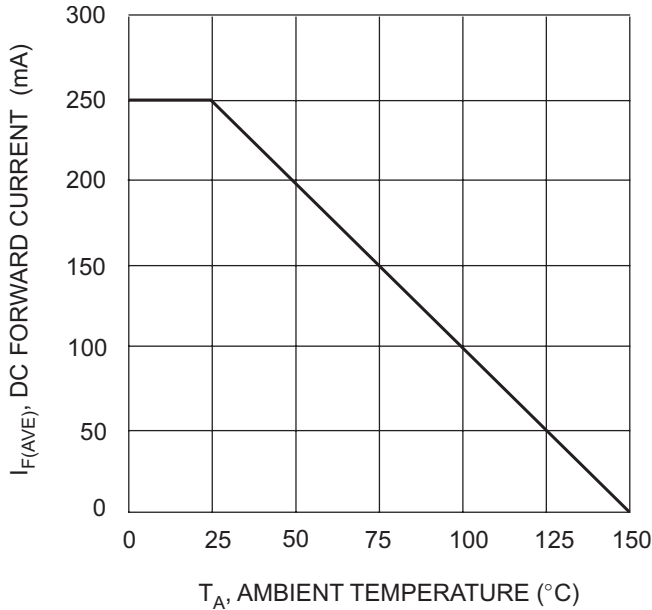

Fig. 1 Forward Current Derating Curve

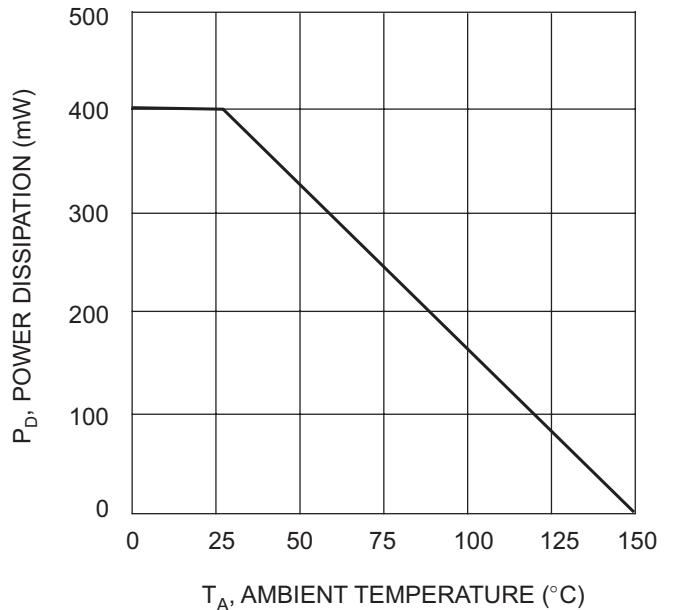

Fig. 2 Power Derating Curve

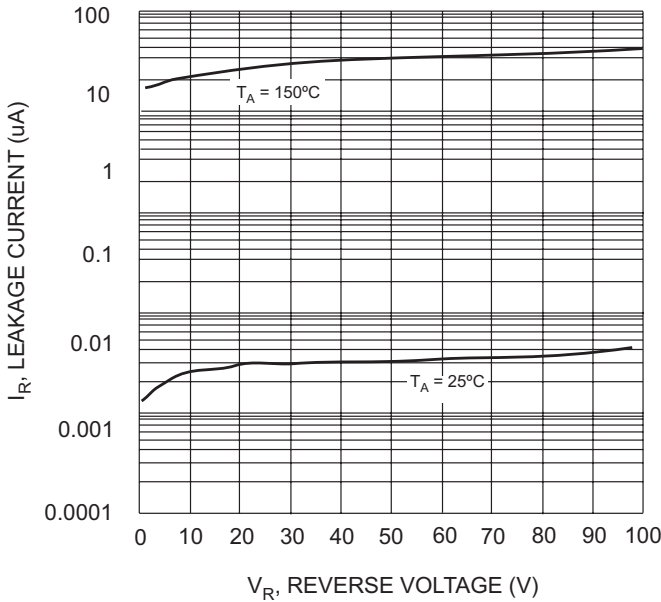

Fig. 3 Typical Reverse Characteristics

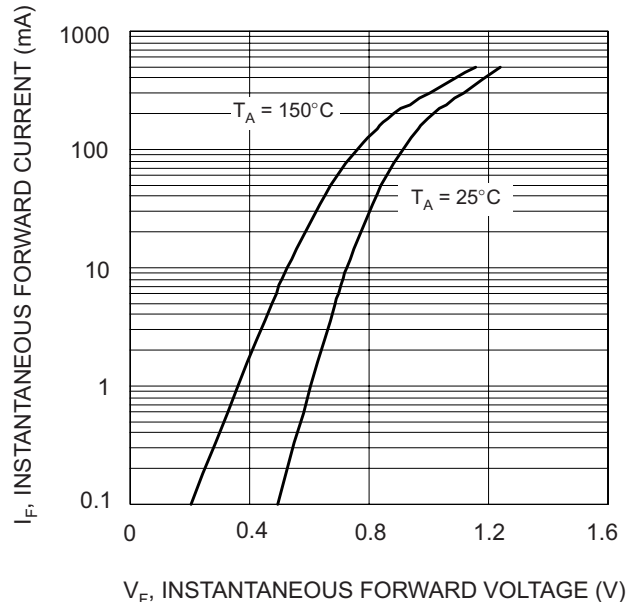

Fig. 4 Typical Forward Characteristics

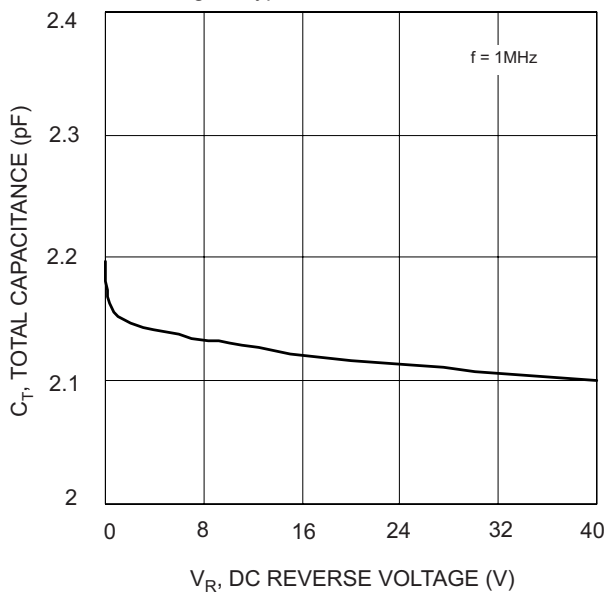

Fig. 5 Total Capacitance vs. Reverse Voltage

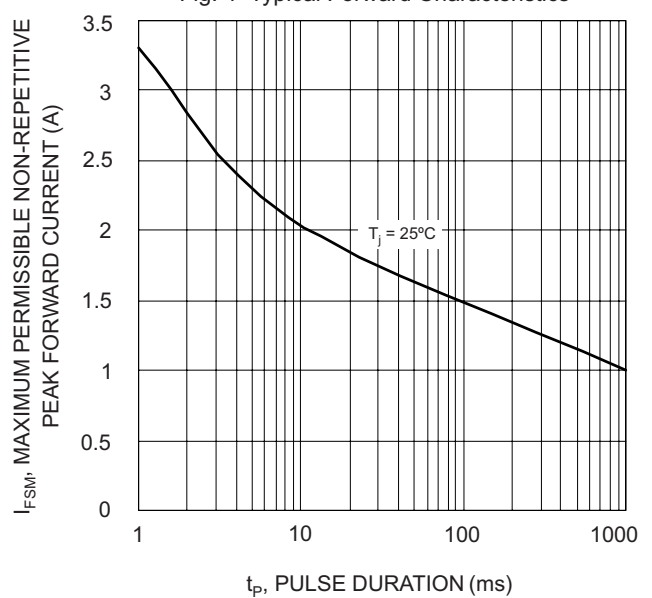

Fig. 6 Maximum Permissible Non-Repetitive Peak Forward Current as a function of pulse duration

Ordering Information (Note 5)

Device	Packaging	Shipping
PD3SD2580-7	Power DI™323	3000/Tape & Reel

Notes: 5. For Packaging Details, go to our website at <http://www.diodes.com/datasheets/ap02007.pdf>.

Marking Information



D1 = Product Type Marking Code, See Page 1
 YM = Date Code Marking
 Y = Year (ex: T = 2006)
 M = Month (ex: 9 = September)

Date Code Key

Year	2006	2007	2008	2009	2010	2011	2012
Code	T	U	V	W	X	Y	Z

Month	Jan	Feb	Mar	Apr	May	Jun	Jul	Aug	Sep	Oct	Nov	Dec
Code	1	2	3	4	5	6	7	8	9	O	N	D

Package Outline Dimensions

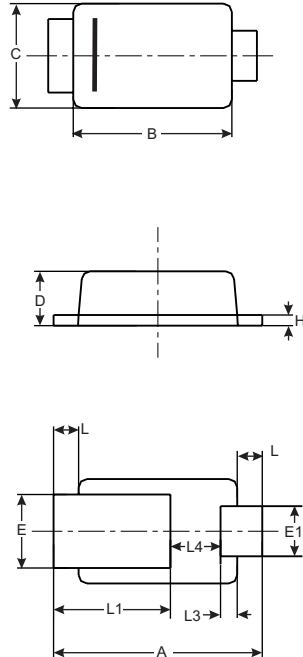

PowerDI™323			
Dim	Min	Max	Typ
A	2.40	2.60	2.50
B	1.85	1.95	1.90
C	1.20	1.30	1.25
D	0.60	0.70	0.65
E	0.78	0.98	0.88
E1	0.50	0.70	0.60
H	0.08	0.18	0.13
L	0.20	0.40	0.30
L1	—	—	1.40
L3	—	—	0.20
L4	0.40	0.80	0.60

All Dimensions in mm

Suggested Pad Layout

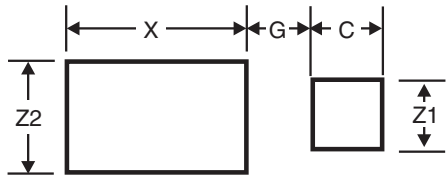

Dimensions	Value (in mm)
Z1	0.8
Z2	1.1
G	0.5
X	2.0
C	0.8

IMPORTANT NOTICE

Diodes Incorporated and its subsidiaries reserve the right to make modifications, enhancements, improvements, corrections or other changes without further notice to any product herein. Diodes Incorporated does not assume any liability arising out of the application or use of any product described herein; neither does it convey any license under its patent rights, nor the rights of others. The user of products in such applications shall assume all risks of such use and will agree to hold Diodes Incorporated and all the companies whose products are represented on our website, harmless against all damages.

LIFE SUPPORT

Diodes Incorporated products are not authorized for use as critical components in life support devices or systems without the expressed written approval of the President of Diodes Incorporated.