

PD413PI

High Speed Type Photodiode

■ Features

1. Built-in visible light cut-off filter
(Sensitivity wavelength range : 750 to 1070 nm)
2. Half intensity angle : $\Delta\theta : \pm 45^\circ$

■ Applications

1. Portable information terminal equipment
2. Personal computers
3. Printers

■ Outline Dimensions

(Unit : mm)

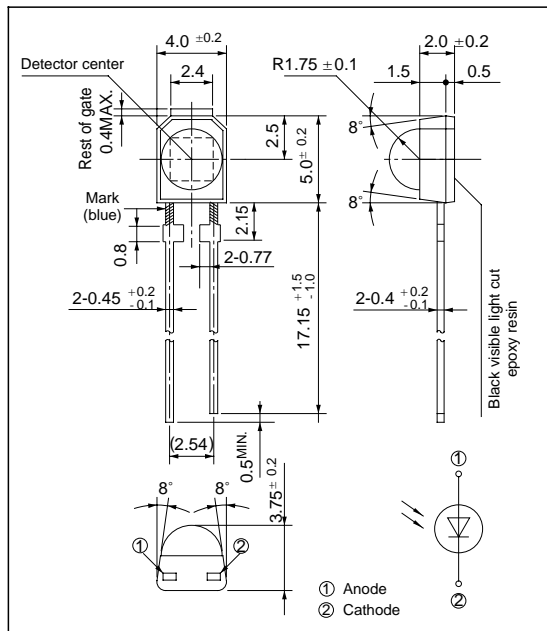

■ Absolute Maximum Ratings

(Ta=25°C)

| Parameter | Symbol | Rating | Unit |
|--------------------------|-----------|---------------|------|
| Reverse voltage | V_R | 32 | V |
| Power dissipation | P | 150 | mW |
| Operating temperature | T_{opr} | - 25 to + 85 | °C |
| Storage temperature | T_{stg} | - 40 to + 100 | °C |
| *1 Soldering temperature | T_{sol} | 260 | °C |

*1 For 5 seconds at the position of 2.15 mm from bottom face of resin package

■ Electro-optical Characteristics

(Ta=25 °C)

| Parameter | Symbol | Conditions | MIN. | TYP. | MAX. | Unit |
|-----------------------------|----------------|---|------|----------|------|---------------|
| Shortcircuit current | I_{SC} | $E_v^{*2} = 100 \text{ lx}$ | 4.5 | 5.4 | 8.1 | μA |
| Dark current | I_d | $V_R = 10\text{V}, E_v = 0$ | - | - | 10 | nA |
| Forward voltage | V_F | $I_F = 1\text{mA}$ | - | - | 1 | V |
| Terminal capacitance | C_t | $V_R = 3\text{V}, f = 1\text{MHz}$ | - | 20 | 35 | pF |
| Peak sensitivity wavelength | λ_p | - | - | 960 | - | nm |
| Half intensity angle | $\Delta\theta$ | - | - | ± 45 | - | ° |
| Response time | t_r, t_f | $R_L = 1\text{k}\Omega, V_R = 10\text{V}$ | - | 200 | - | ns |

*2 E_v : Illuminance by CIE standard light source A (tungsten lamp)

Fig. 1 Power Dissipation vs. Ambient Temperature

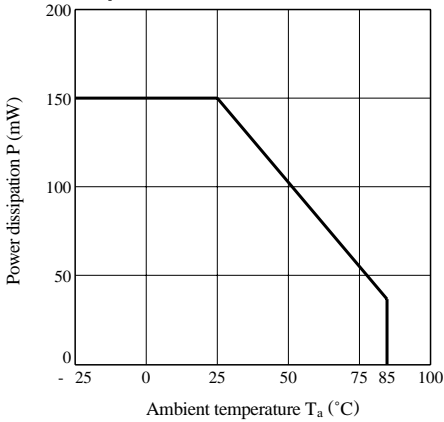

Fig. 2 Spectral Sensitivity

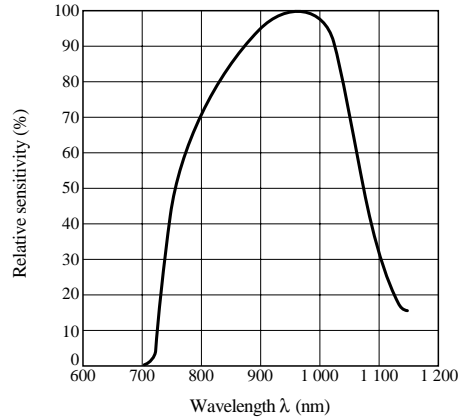

Fig. 3 Shortcircuit Current vs. Illuminance

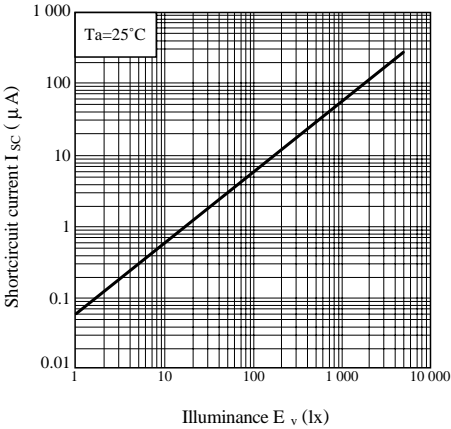

Fig. 4 Dark Current vs. Ambient Temperature

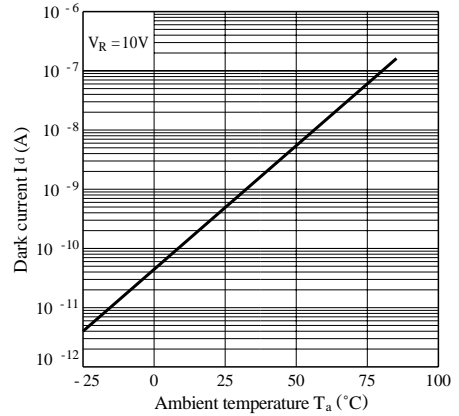

Fig. 5 Dark Current vs. Reverse Voltage

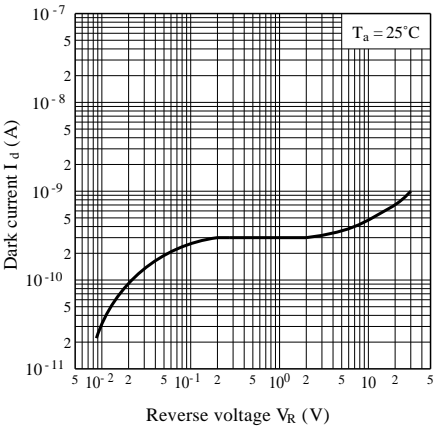

Fig. 6 Terminal Capacitance vs. Reverse Voltage

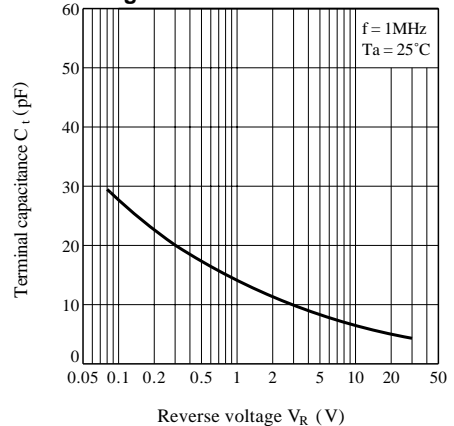

Fig. 7 Relative Output vs. Ambient Temperature (Detector : GL537/GL538)

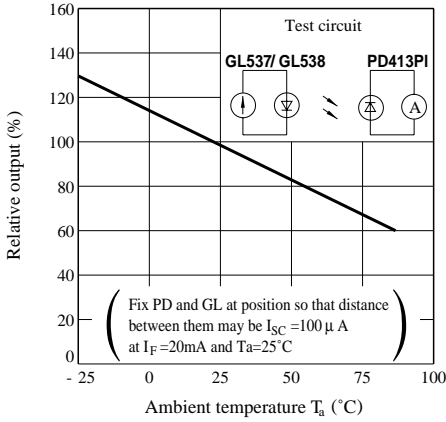

Fig. 8 Radiation Diagram ($T_a = 25^{\circ}\text{C}$)

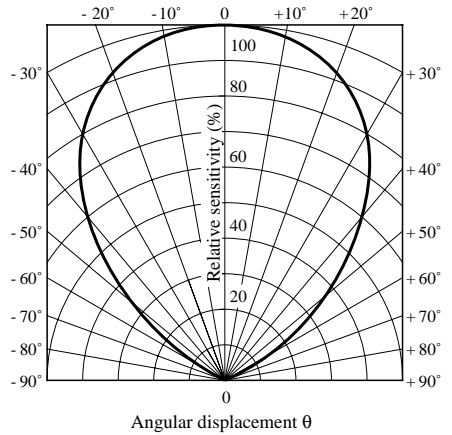

Fig. 9 Relative Output vs. Distance (Detector : GL537/GL538)

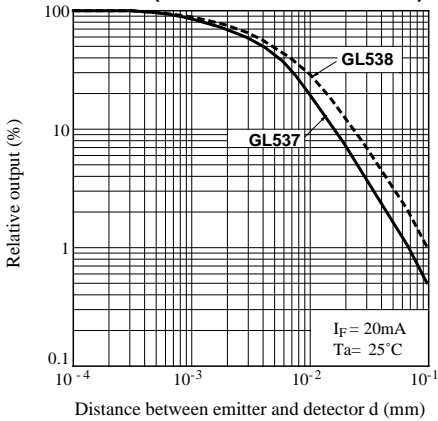
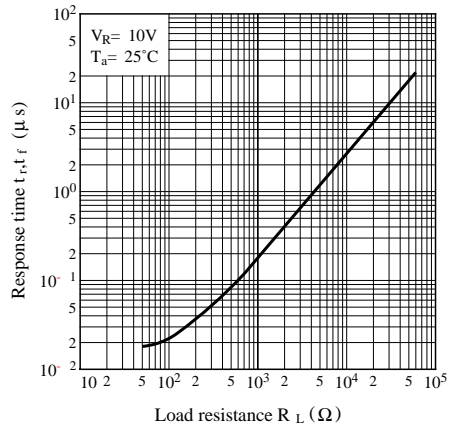

Fig. 10 Response Time vs. Load Resistance



Test Circuit for Response Time

