



# PD57030 PD57030S

## RF POWER TRANSISTORS The LdmoST Plastic FAMILY

### N-CHANNEL ENHANCEMENT-MODE LATERAL MOSFETs

- EXCELLENT THERMAL STABILITY
- COMMON SOURCE CONFIGURATION
- $P_{OUT} = 30\text{ W}$  with 14 dB gain @ 945 MHz / 28V
- NEW RF PLASTIC PACKAGE

#### DESCRIPTION

The PD57030 is a common source N-Channel, enhancement-mode lateral Field-Effect RF power transistor. It is designed for high gain, broad band commercial and industrial applications. It operates at 28 V in common source mode at frequencies up to 1 GHz.

PD57030 boasts the excellent gain, linearity and reliability of ST's latest LDMOS technology mounted in the first true SMD plastic RF power package, PowerSO-10RF. PD57030's superior linearity performance makes it an ideal solution for base station applications.

The PowerSO-10 plastic package, designed to offer high reliability, is the first ST JEDEC approved, high power SMD package. It has been specially optimized for RF needs and offers excellent RF performances and ease of assembly.

*Mounting recommendations are available in [www.st.com/rf/](http://www.st.com/rf/) (look for application note AN1294)*

#### ABSOLUTE MAXIMUM RATINGS ( $T_{CASE} = 25\text{ }^{\circ}\text{C}$ )

Symbol	Parameter	Value	Unit
$V_{(BR)DSS}$	Drain-Source Voltage	65	V
$V_{GS}$	Gate-Source Voltage	$\pm 20$	V
$I_D$	Drain Current	4	A
$P_{DISS}$	Power Dissipation (@ $T_c = 70\text{ }^{\circ}\text{C}$ )	52.8	W
$T_j$	Max. Operating Junction Temperature	165	$^{\circ}\text{C}$
$T_{STG}$	Storage Temperature	-65 to +150	$^{\circ}\text{C}$

#### THERMAL DATA

$R_{th(j-c)}$	Junction -Case Thermal Resistance	1.8	$^{\circ}\text{C/W}$
---------------	-----------------------------------	-----	----------------------

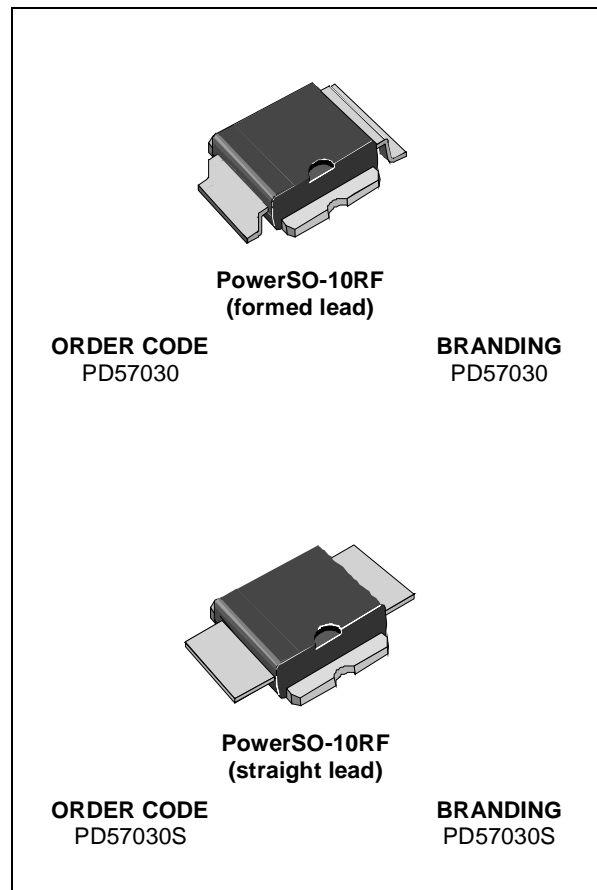

**PD57030 - PD57030S**

**ELECTRICAL SPECIFICATION** ( $T_{CASE} = 25\text{ }^{\circ}\text{C}$ )

**STATIC**

Symbol	Test Conditions		Min.	Typ.	Max.	Unit
$V_{(BR)DSS}$	$V_{GS} = 0\text{ V}$	$I_{DS} = 10\text{ mA}$	65			V
$I_{DSS}$	$V_{GS} = 0\text{ V}$	$V_{DS} = 28\text{ V}$			1	$\mu\text{A}$
$I_{GSS}$	$V_{GS} = 20\text{ V}$	$V_{DS} = 0\text{ V}$			1	$\mu\text{A}$
$V_{GS(Q)}$	$V_{DS} = 28\text{ V}$	$I_D = 50\text{ mA}$	2.0		5.0	V
$V_{DS(ON)}$	$V_{GS} = 10\text{ V}$	$I_D = 3\text{ A}$		1.3		V
$g_{FS}$	$V_{DS} = 10\text{ V}$	$I_D = 3\text{ A}$		1.8		mho
$C_{ISS}$	$V_{GS} = 0\text{ V}$	$V_{DS} = 28\text{ V}$		57		pF
$C_{OSS}$	$V_{GS} = 0\text{ V}$	$V_{DS} = 28\text{ V}$		30		pF
$C_{RSS}$	$V_{GS} = 0\text{ V}$	$V_{DS} = 28\text{ V}$		2.3		pF

**DYNAMIC**

Symbol	Test Conditions		Min.	Typ.	Max.	Unit
$P_{OUT}$	$V_{DS} = 28\text{ V}$	$I_{DQ} = 50\text{ mA}$ $f = 945\text{ MHz}$	30			W
$G_P$	$V_{DS} = 28\text{ V}$	$I_{DQ} = 50\text{ mA}$ $P_{OUT} = 30\text{ W}$ $f = 945\text{ MHz}$	13	14		dB
$\eta_D$	$V_{DS} = 28\text{ V}$	$I_{DQ} = 50\text{ mA}$ $P_{OUT} = 30\text{ W}$ $f = 945\text{ MHz}$	45	53		%
Load mismatch	$V_{DS} = 28\text{ V}$	$I_{DQ} = 50\text{ mA}$ $P_{OUT} = 30\text{ W}$ $f = 945\text{ MHz}$ ALL PHASE ANGLES	10:1			VSWR

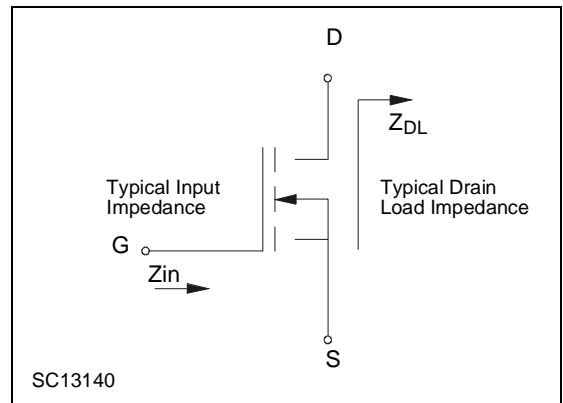
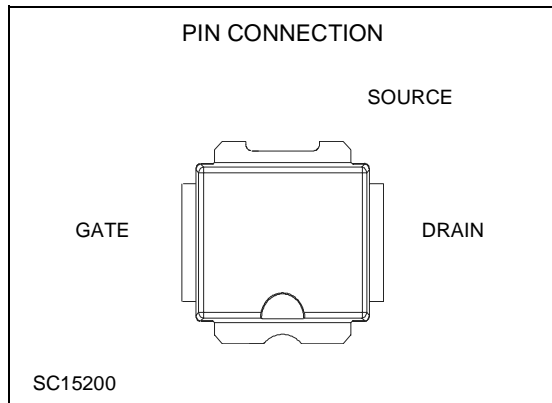

**IMPEDANCE DATA**

PD57030S

FREQ. MHz	$Z_{IN}(\Omega)$	$Z_{DL}(\Omega)$
925	$0.929 - j 0.315$	$2.60 + j 1.45$
945	$0.809 - j 0.085$	$2.46 + j 0.492$
960	$0.763 - j 0.428$	$2.35 + j 0.591$

TYPICAL PERFORMANCE

Capacitances vs. Drain Voltage

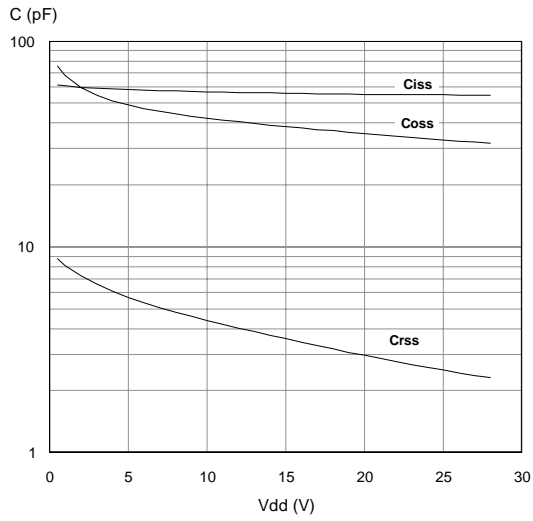

Drain Current vs Gate-Source Voltage

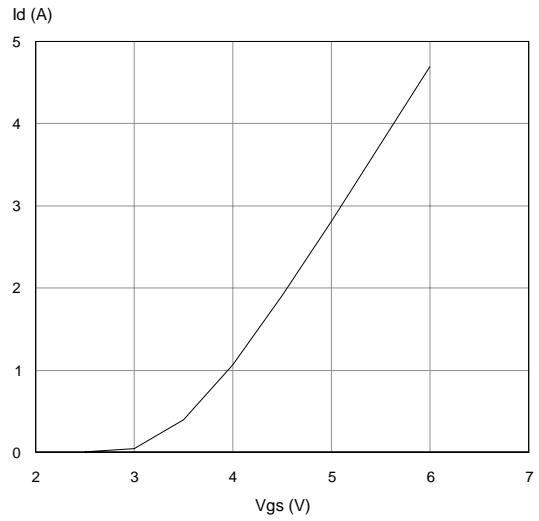

Gate-Source Voltage vs Case Temperature

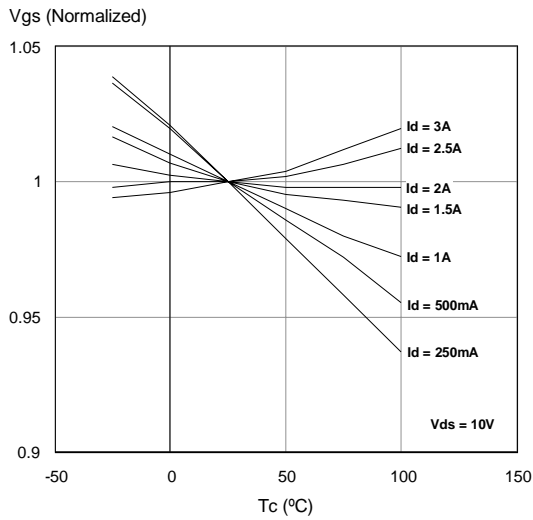

# PD57030 - PD57030S

## TYPICAL PERFORMANCE (PD57030S)

### Output Power vs Input Power

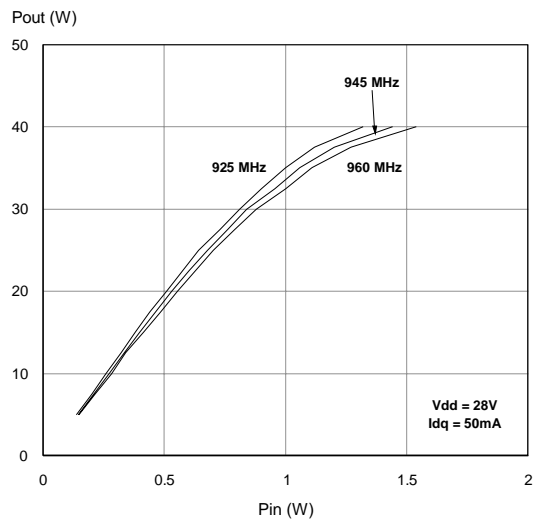

### Input Return Loss vs Output Power

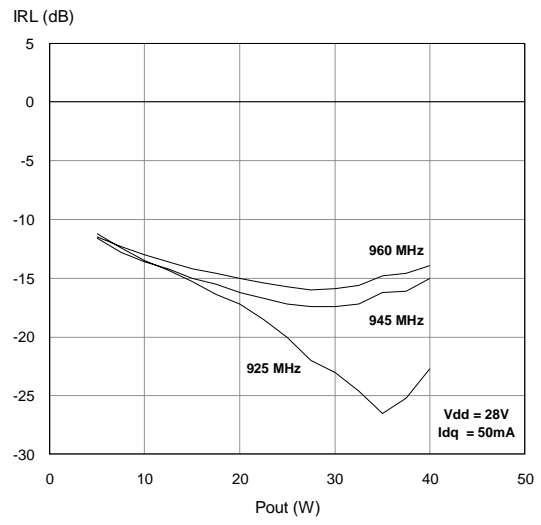

### Power Gain vs Output Power

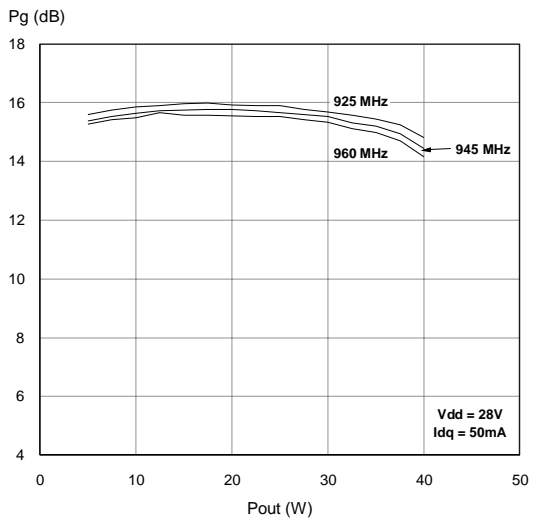

### Efficiency vs. Output Power

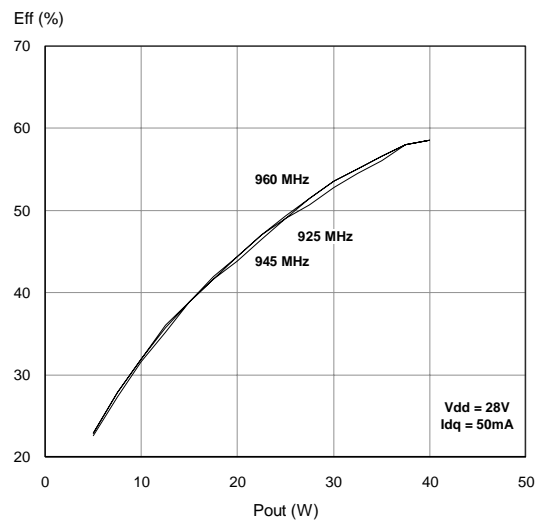

### Output Power vs Bias Current

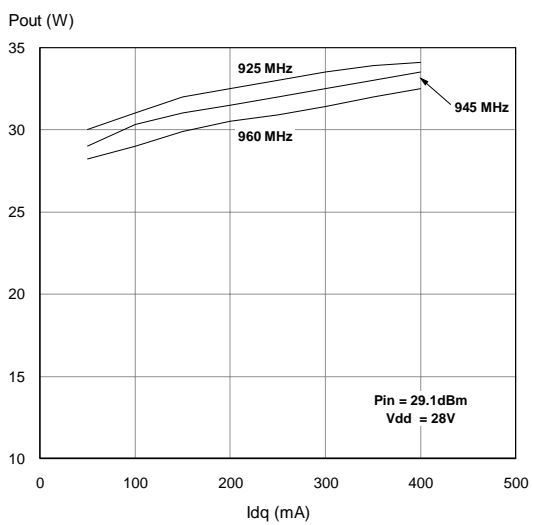

### Efficiency vs Bias Current

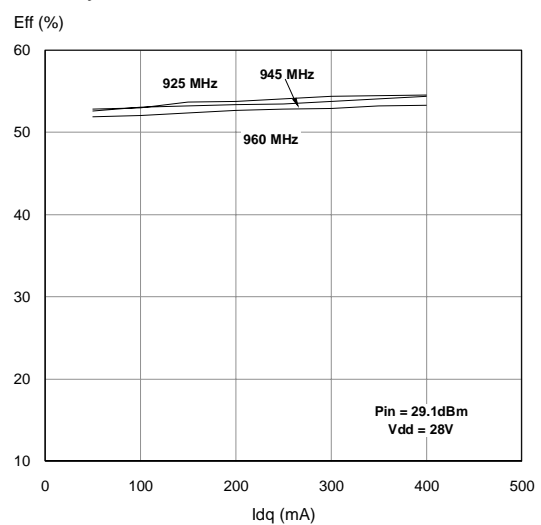

TYPICAL PERFORMANCE (PD57030S)

Output Power vs Drain Voltage

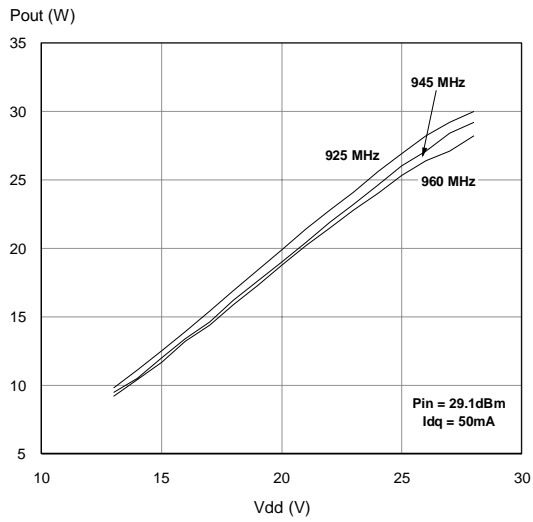

Efficiency vs Drain Voltage

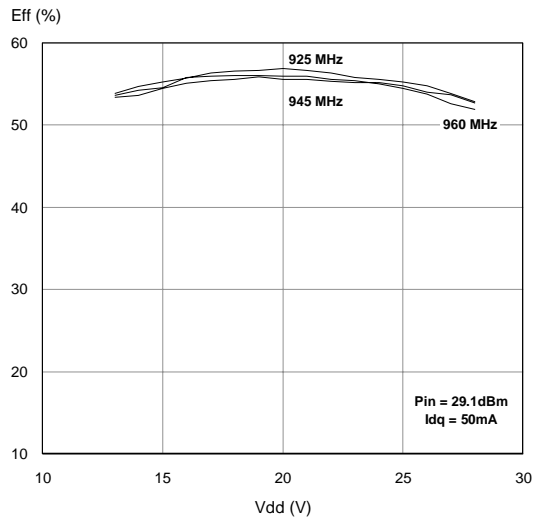

Output Power vs Gate-Source Voltage

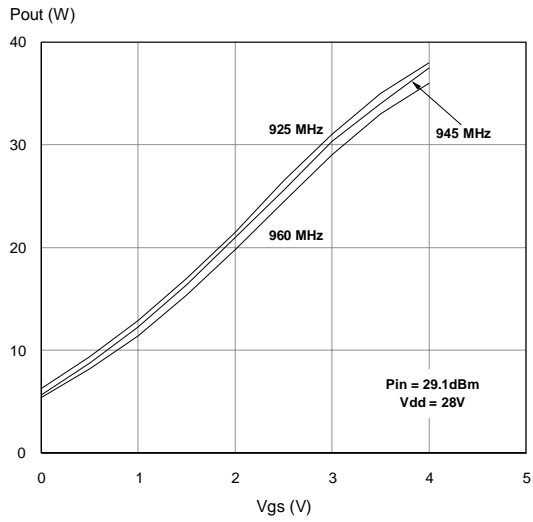

TEST CIRCUIT SCHEMATIC

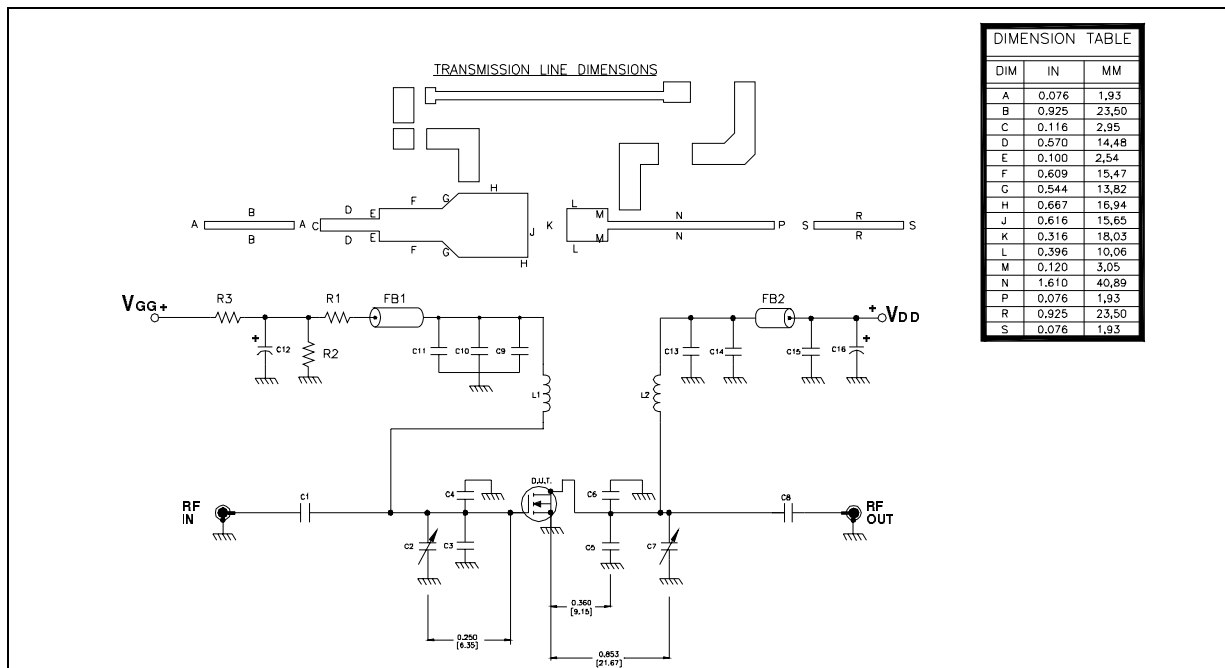

TEST CIRCUIT COMPONENT PART LIST

COMPONENT	DESCRIPTION
C1, C8, C9, C13	47pF ATC 100B SURFACE MOUNT CERAMIC CHIP CAPACITOR
C2, C7	0.8-8.0pF GIGA TRIM VARIABLE CAPACITOR
C3, C4, C5, C6	7.5pF ATC 100B SURFACE MOUNT CERAMIC CHIP CAPACITOR
C10	1000pF ATC 100B SURFACE MOUNT CERAMIC CHIP CAPACITOR
C11, C15	0.1μF / 500V SURFACE MOUNT CERAMIC CHIP CAPACITOR
C12	10μF / 50V ALUMINUM ELECTROLYTIC RADIAL LEAD CAPACITOR
C14	100pF ATC 100B SURFACE MOUNT CERAMIC CHIP CAPACITOR
C16	220μF / 63V ALUMINUM ELECTROLYTIC RADIAL LEAD CAPACITOR
R1	18KΩ, 1W SURFACE MOUNT CHIP RESISTOR
R2	4.7MΩ, 1W SURFACE MOUNT CHIP RESISTOR
R3	120Ω, 2W SURFACE MOUNT CHIP RESISTOR
FB1, FB2	SHIELD BEAD SURFACE MOUNT EMI
L1, L2	INDUCTOR, 5TURNS AIR WOUND #22AWG, ID=0.059[1.49], NYLON COATED MAGNET WIRE

TEST CIRCUIT

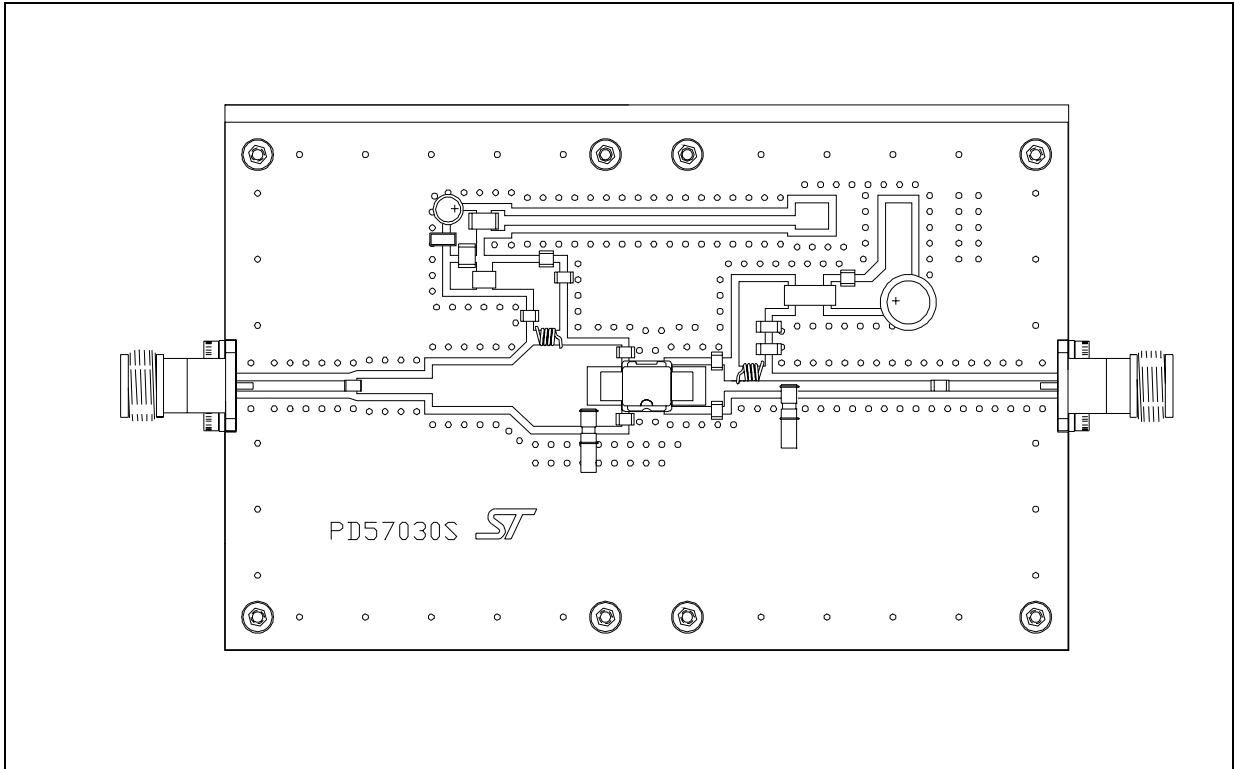

TEST CIRCUIT PHOTOMASTER

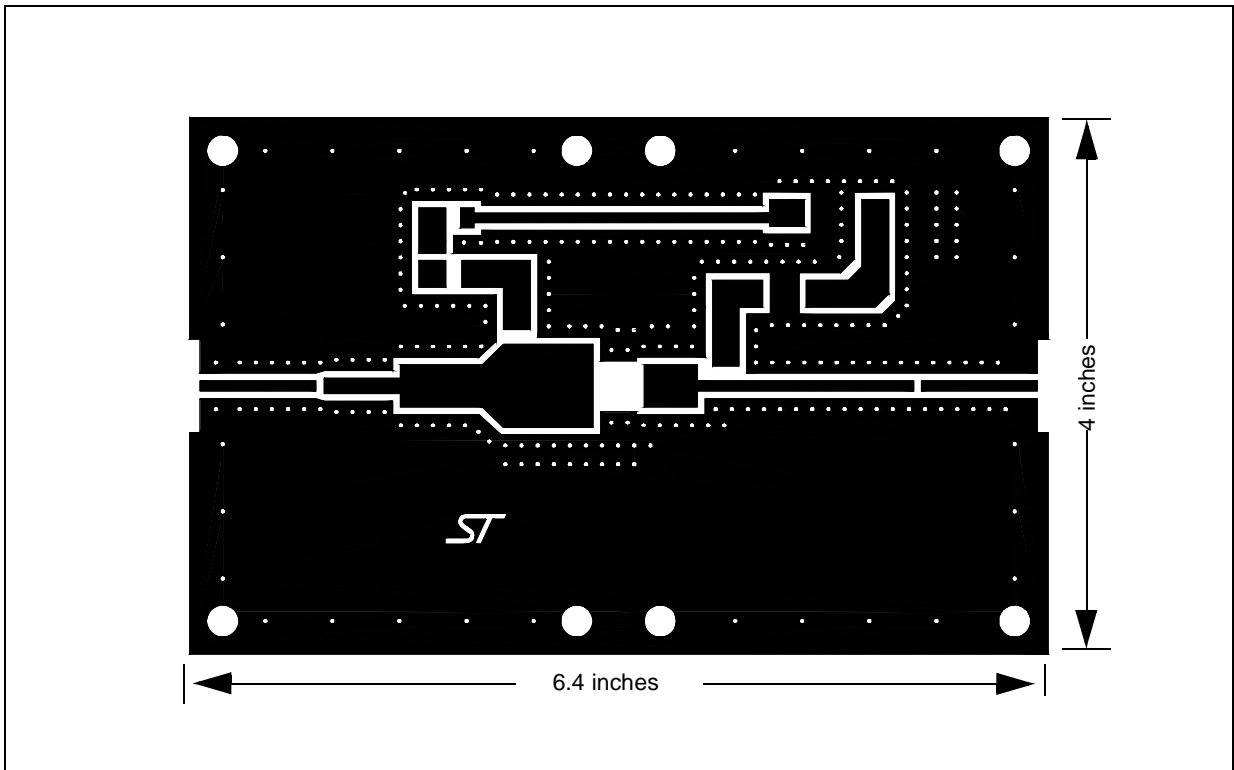

Information furnished is believed to be accurate and reliable. However, STMicroelectronics assumes no responsibility for the consequences of use of such information nor for any infringement of patents or other rights of third parties which may result from its use. No license is granted by implication or otherwise under any patent or patent rights of STMicroelectronics. Specifications mentioned in this publication are subject to change without notice. This publication supersedes and replaces all information previously supplied. STMicroelectronics products are not authorized for use as critical components in life support devices or systems without express written approval of STMicroelectronics.

The ST logo is registered trademark of STMicroelectronics  
© 2003 STMicroelectronics - All Rights Reserved

All other names are the property of their respective owners.

STMicroelectronics GROUP OF COMPANIES  
Australia - Brazil - China - Finland - France - Germany - Hong Kong - India - Italy - Japan - Malaysia - Malta - Morocco -  
Singapore - Spain - Sweden - Switzerland - United Kingdom - U.S.A.

<http://www.st.com>