

1. PART NO. EXPRESSION :

P D B 1 7 0 4 1 R 2 M Z F
 (a) (b) (c) (d)(e)(f)

- (a) Series code
- (b) Dimension code
- (c) Inductance code : 1R2 = 1.2uH
- (d) Tolerance code : M = ±20%
- (e) X, Y, Z : Standard part
- (f) F : Lead Free

2. CONFIGURATION & DIMENSIONS :

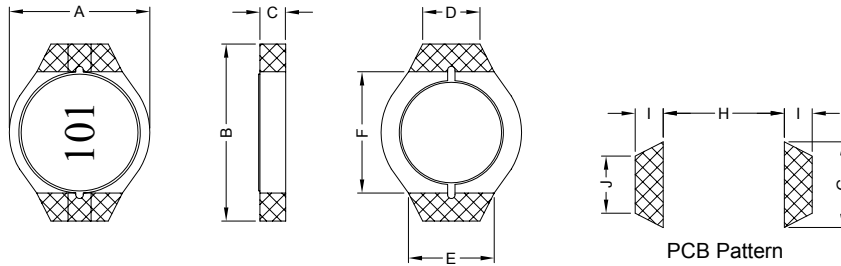

Unit:m/m

A	B	C	D	E	F	G	H	I	J
5.50 Max.	6.60 Max.	1.00 Max.	2.50±0.2	3.40±0.3	4.90±0.3	3.80 Ref.	4.70 Ref.	1.10 Ref.	2.50 Ref.

3. SCHEMATIC :

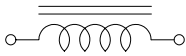

4. MATERIALS :

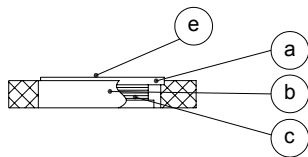

- (a) Core : DR Ferrite Core
- (b) Base : Ceramic Base
- (c) Wire : Enamelled Copper Wire
- (d) Adhesive : Epoxy
- (e) Ink : Bon Margue

5. GENERAL SPECIFICATION :

- a) Temp. rise : 40°C Max. at Irms
- b) $\Delta L/L0A = 10\%$ Max. at Isat
- c) Storage temp. : -40°C to +125°C
- d) Operating temp. : -40°C to +85°C
- e) Resistance to solder heat : 260°C.10 secs



RoHS Compliant

NOTE : Specifications subject to change without notice. Please check our website for latest information.

12.05.2008



SUPERWORLD ELECTRONICS (S) PTE LTD

6. ELECTRICAL CHARACTERISTICS :

Part No.	Inductance (μ H)	Test Frequency (Hz)	SRF (MHz) Typ.	RDC (Ω) Max.	Isat (A)	Irms (A)
PDB17041R2MZF	1.2 \pm 20%	0.1V/100K	190.0	0.08	2.10	1.70
PDB17041R5MZF	1.5 \pm 20%	0.1V/100K	140.0	0.10	1.90	1.50
PDB17042R2MZF	2.2 \pm 20%	0.1V/100K	115.0	0.12	1.60	1.40
PDB17043R3MZF	3.3 \pm 20%	0.1V/100K	90.0	0.16	1.30	1.20
PDB17044R7MZF	4.7 \pm 20%	0.1V/100K	88.0	0.20	1.10	1.10
PDB17046R8MZF	6.8 \pm 20%	0.1V/100K	66.0	0.32	0.90	0.85
PDB1704100MZF	10.0 \pm 20%	0.1V/100K	55.0	0.41	0.80	0.75
PDB1704150MZF	15.0 \pm 20%	0.1V/100K	42.0	0.55	0.65	0.60
PDB1704220MZF	22.0 \pm 20%	0.1V/100K	38.0	0.85	0.50	0.52
PDB1704330MZF	33.0 \pm 20%	0.1V/100K	29.0	1.30	0.40	0.42
PDB1704470MZF	47.0 \pm 20%	0.1V/100K	22.0	1.80	0.35	0.36
PDB1704680MZF	68.0 \pm 20%	0.1V/100K	18.0	2.50	0.30	0.30
PDB1704101MZF	100.0 \pm 20%	0.1V/100K	14.0	3.50	0.25	0.26
PDB1704151MZF	150.0 \pm 20%	0.1V/100K	12.0	5.00	0.18	0.21
PDB1704221MZF	220.0 \pm 20%	0.1V/100K	10.0	7.00	0.16	0.18
PDB1704331MZF	330.0 \pm 20%	0.1V/100K	8.0	15.00	0.13	0.13



RoHS Compliant

NOTE : Specifications subject to change without notice. Please check our website for latest information.

12.05.2008



SUPERWORLD ELECTRONICS (S) PTE LTD

7. CHARACTERISTICS CURVES :

@ TEMP. RISE VS. DC SUPERPOSITION RESPONSE CURVE

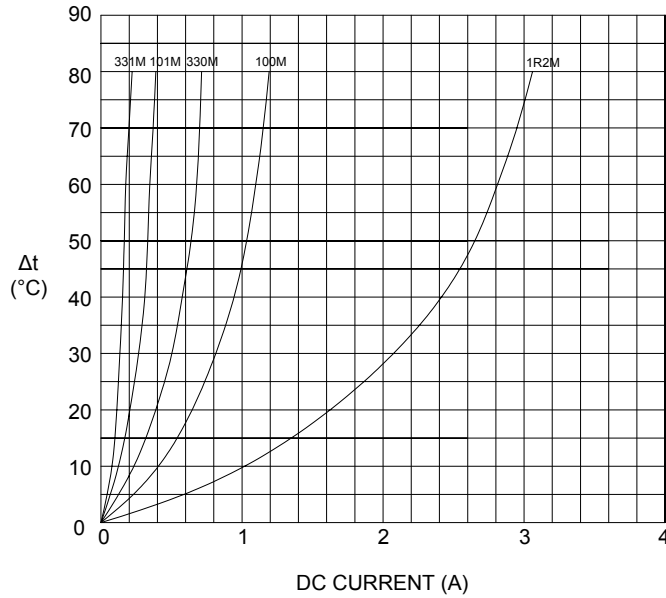

@ INDUCTANCE VS. FREQUENCY RESPONSE CURVE

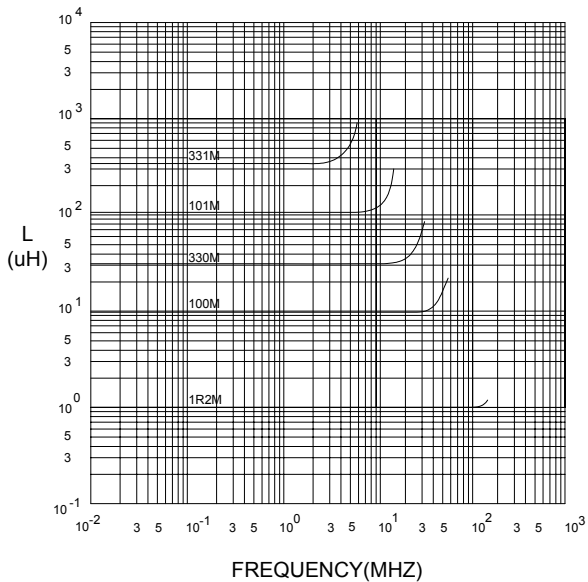

@ INDUCTANCE VS. DC SUPERPOSITION RESPONSE CURVE

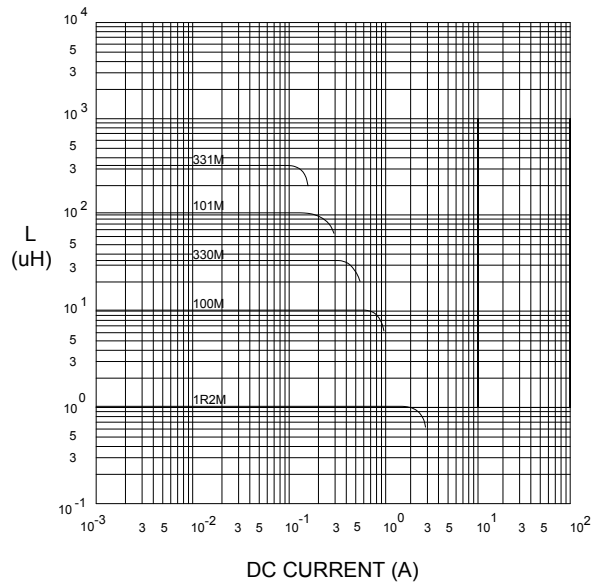

RoHS Compliant

NOTE : Specifications subject to change without notice. Please check our website for latest information.

12.05.2008



SUPERWORLD ELECTRONICS (S) PTE LTD

RECOMMENDED SOLDERING CONDITIONS REFLOW SOLDERINGS

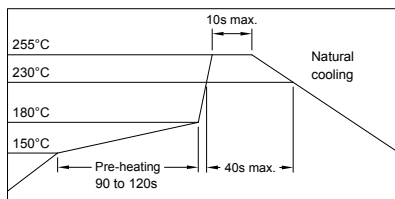

8. PACKAGING INFORMATION :

(1) CONFIGURATION

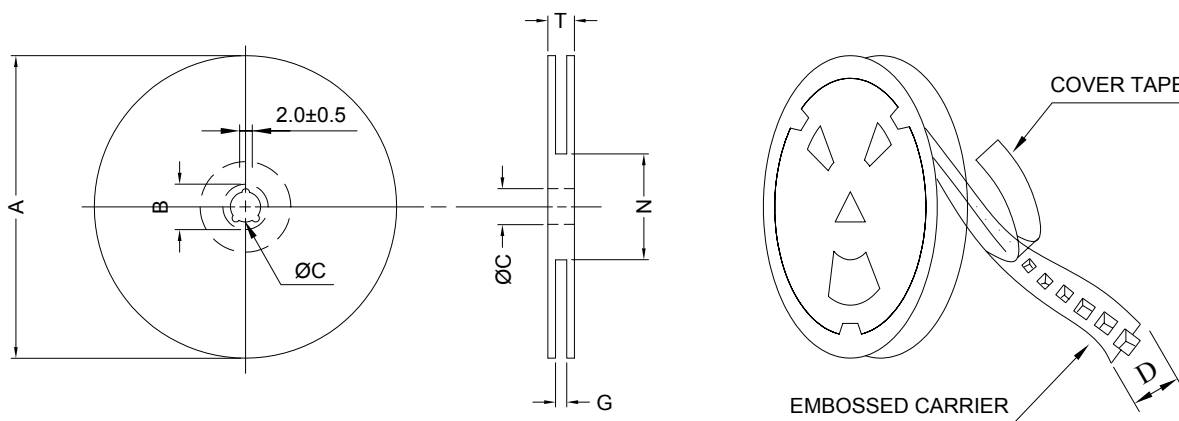

* CARRIER TAPE WIDTH : D

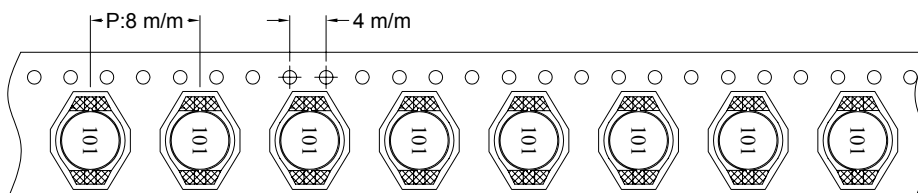

(2) DIMENSIONS

Unit:m/m

STYLE	A	B	C	D	G	N	T
7-16	178	21±0.8	13±0.5	16	14 ⁺⁰	50 ⁻⁰	22.4

(3) Q'TY & G.W. PER PACKAGE

SERIES	INNER : REEL			OUTER : CARTON		
	Q'TY (PCS)	G.W. (gw)	STYLE	Q'TY (PCS)	G.W. (Kg)	SIZE (cm)
PDB1704	1000	350	7-16	5000	5.30	21 x 20 x 20



RoHS Compliant

NOTE : Specifications subject to change without notice. Please check our website for latest information.

12.05.2008

9. RELIABILITY AND TEST CONDITION :

TEST ITEM	SPECIFICATION	TEST CONDITION
SOLDERABILITY	MORE THAN 90% OF THE TERMINAL ELECTRODE SHALL BE COVERED WITH FRESH SOLDER.	PREHEAT : 125±25°C FOR 60 SECONDS SOLDER : 99%Sn/0.3%Ag/0.7%Cu OR EQUIVALENT SOLDER TEMP. : 245±5°C FLUX : ROSIN DIP TIME : 4±1 SECONDS
THERMAL SHOCK TEST (TEMP. CYCLE)	INDUCTANCE SHALL NOT CHANGE MORE THAN ±20%	ROOM TEMP. → -25±2°C 15 MINUTES → 30 MINUTES ROOM TEMP. → 85±2°C 15 MINUTES → 30 MINUTES TOTAL : 50 CYCLES
HUMIDITY RESISTANCE TEST		TEMPERATURE : 40±2°C HUMIDITY : 90 ~ 95% APPLIED CURRENT : PER SPEC. TIME : 500 HOURS
HIGH TEMP. RESISTANCE TEST		TEMPERATURE : 85±2°C APPLIED CURRENT : PER SPEC. TIME : 500 HOURS

10. UL CARD :

OBMW2		November 30, 2000		
Magnet Wire - Component				
PACIFIC ELECTRIC WIRE & CABLE (SHENZHEN) CO LTD				E201757
607 BAOLONG INDUSTRIAL ESTATE LONGGANG, SHENZHEN				
GUANGDONG CHINA				
	Coating Type			
Mtl Dsg	BC	TC	ANSI Type	TI
UEW/U	Polyurethane	—	—	130
PEW/U	Polyester	—	MW5-C	155°C
PEWH/U	Modified Polyester	—	MW30-C	180
PEW-NY/U	Polyester	Polyamide	MW24-C	155
HAI/U	Polyester(Amide)(Imide)	Polyamideimide	MW35,73	200
UEW-NY/U	Polyurethane	Polyamide	MW80-C	155
			MW28-C	130
 Marking: Company name and material designation or marked designation on package or reel, and Recognized Component Mark.				
See General Information Preceding These Recognitions				
1/3/2001	Underwriters Laboratories Inc.		Card 1 of 2	



RoHS Compliant

NOTE : Specifications subject to change without notice. Please check our website for latest information.

12.05.2008

